

# Protecting Your Exit Strategies

TEI-SJSU High Tech Tax Institute  
November 2017

Jill Harding



Jill Franciosi



Melanie Krygier



Eileen Marshall



## Contents

---

1 Competing Considerations of Buyers and Sellers

---

2 Due Diligence – Common “Gotchas”

- Federal & State and Local Issues
- Cross Border Considerations

---

3 Purchase Agreement Considerations

---

Acquisition Structures & Tax Benefits

- Taxable Structures
- Spin-Off Exits
  - Strategic Rationale
  - Comparison of Taxable and Tax-Free Spins

4

- Requirements for Tax-Free Spins
- Basic Section 355 Structures
- Control Gathering Transactions
- Methods for Extracting Value
- Other Current Developments
- Certain Tax-Free Structures

---

# Competing Considerations of Buyers and Sellers

## Buyer/Seller Objectives

---

### **Buyer**

- Basis Step-up.
- Carryover of Pre-Closing Tax Liabilities.
- Carryover of Target Attributes (e.g., NOLs & Basis).
- Nature & Character of Target Assets.
- Exit Strategy – Minimize Exit Taxes / Ability to Convey Step-up to Future Buyer.

### **Seller**

- Maximizing Sale Proceeds.
- Deferral of Gain.
- Attribute Utilization.
- Character of Gain (Capital vs. Ordinary, Recapture).

### **Both**

- Transaction Liabilities (e.g., Transaction Deductions, Incremental Taxes, Transfer Taxes).
- Escrow / Indemnity.
- Management Team / Compensation Incentives.

# Divestiture Tax Strategy

---

## **Divestiture tax strategy focuses on the following:**

- Determination of the preferred method of divestiture, such as a spin off (e.g., public spin, Private Equity sponsored spin, leveraged spin, etc.), joint-venture, asset vs stock sale, combination of the foregoing, etc.
- Planning related to the mitigation of immediate taxation related to the divestiture, including purchase price allocation planning and efficient use of US and foreign tax attributes.
- Use of and effects on US FTC position to the extent the divestiture happens outside of the US.
- Assessing the impact on existing transfer pricing arrangements.
- Repatriation of foreign sales proceeds in a tax efficient manner to the extent that the divestiture happens outside of the US.

**Typically, such strategy not only covers pre-sale planning but also post-closing items, such as purchase price adjustment mechanisms.**

## Why Undertake Diligence?

---

### Identification of Pre-Closing Tax Exposures

- Income (Statute of Limitations is Typically Three to Four Years).
- Non-Income (Statute of Limitations Varies by Taxing Jurisdiction).
- Sales and Use Tax.
- Excise Tax, Gross Receipts- Based Tax e.g. Business and Occupation Tax.
- Payroll Tax.
- Property Tax.
- Unclaimed Property.

### Identify Impediments/Opportunities for Acquisition Structure

### Contract Review / Working Capital Analysis

7

## Why Undertake Diligence? (cont'd)

---

### Inform Post-Close Planning

- Transaction Taxes.
- Transaction Deductions (e.g., advisor fees, bonuses, options).
- Incremental Taxes (e.g., 338(h)(10), 280G, DIGs, withholding).
- Transfer Taxes.
- Gain Deferral / Future Tax Shield.
- Basis Step-up and Corresponding Tax Benefits.
- NOL Utilization and Restrictions.
- Global Effective Tax Minimization / Repatriation Planning.
- Exit Strategies.

8

## Diligence Considerations: Asset Acquisition Scope

---

### Historical Income Tax Exposures

- Generally do not carry over.

### Non-Income Taxes

- Sales and Use Tax.
- Excise Tax, Gross Receipts- Based Tax e.g. Business and Occupation Tax.
- Payroll Tax.
- Property Tax.
- Unclaimed Property.

### Transfer Taxes

#### Incremental Taxes to Shareholders

- May be more expensive versus a stock sale.

#### Anti-Churning Rules §197(f)(9)

- Prohibits amortization of goodwill step-up if business was established in 1993 or earlier where the sale is to a related party (common ownership of more than 20%).

9

## Diligence Considerations: Stock Acquisitions

---

### Asset Purchase Scope (i.e., Non-income Taxes) Plus:

- Analysis of Pre-Closing Federal and State Income Taxes.
  - Generally through the open years.
  - Statute of Limitations on Assessment.
  - Federal 3 years unless waived (6 years if underreporting of more than 25% of gross income stated on original return).
  - State 3-4 years for a filed-return unless waived. (6 years, in many states, if underreporting of more than 25% of gross income stated on original return).
- Analysis of Attributes (e.g., Pre-existing Basis / NOLs and Restrictions (Section 382)).

## Diligence Considerations: Carve-Outs from Consolidated Groups

---

**Asset Purchases** (same considerations apply as before).

**Stock Purchases** (same considerations apply as before) – **Plus:**

- Several liability under §1.1502-6.
- T is liable for the entire consolidated group's tax during the time in which it was a member.
- Typically a concern where:
  - a. The consolidated group is financially distressed.
  - b. The consolidated group goes out of existence after the sale.
- Analysis of consolidated attributes and restrictions may be different.
- Tax sharing / indemnity agreements may be applicable.
- Opportunity for 338(h)(10) election (discussed below).
- Attribute / basis reduction pursuant to §1.1502-36.
- Apportionment of Consolidated §382 limit - §1.1502-95(c).

11

## Diligence Considerations: Acquisitions of S Corporations

---

**Same considerations as in a Stock Acquisition - Plus:**

- Evaluation of S corporation validity.
- Potential opportunity for basis step-up under §338(h)(10) if 80% or more of S corporation stock is acquired in the acquisition.
- Built-in gains tax (if converted from a “C” corporation).
- Analysis of state tax treatment of S corporations.
- Same as Federal.
- Was a separate state election required?
- Filing responsibilities including applicable shareholder consents, S corporation withholding requirements, composite returns.

**S Corporation Status is CRITICAL – if a Bad S Corporation, Then:**

- The S corporation is a “C” corporation, liable for income tax from the point of termination forward.
- No §338(h)(10) election (i.e., no step-up).

12

## Diligence Considerations: S Corporation Requirements

---

### **Eligible Corporation** (Generally Any Corp. Except for Certain Financial Institutions and Export Companies)

- 100 Shareholders or less.
- Permissible Shareholders.
- U.S. Resident Individuals.
- Certain Trusts.
- Single Class of Stock.
- Election.

13

## Diligence Considerations: Acquisitions of Partnerships

---

### **Acquisition of 100% of a Partnership or LLC is Treated Like an Asset Purchase From the Buyer's Standpoint (i.e., Buyer Gets a Basis Step-up) (Rev. Rul. 99-6).**

If less than 100% if acquired, Buyer gets no step-up unless a Section 754 election is made or is in effect.

- If so, the buyer gets a proportionate step-up in its share of the partnership assets.

#### **Diligence is Focused on:**

- Non-Income taxes (i.e., sales and use, payroll, and property).
- Certain entity level taxes (e.g., gross receipts, NYC UBT, partner withholding).
- Potential contractual or successor liability from historical mergers or acquisitions.

14

# Diligence Considerations: Cross-Border Transactions

---

## Separate Foreign Tax Regimes

- Taxable presence in foreign jurisdictions.

## Transfer Pricing

### Withholding Tax on “Passive” Type Income (e.g., Dividends, Interest, Rents, Royalties)

- Withholding Tax is generally 30% unless reduced by treaty.

## Earnings Stripping

- Debt / Interest Issues.
- Transfer Pricing.

## Trapped Cash

## Reverse Acquisitions and Corporate Inversion Rules

15

# Existing Tax Attributes: Buyer vs. Seller Considerations

---

## Will target’s NOL carryover post-closing?

Is Target a stand alone C corporation? A member of a consolidated group?

How is the transaction being structured (asset versus stock)?

## Valuation Considerations

What is the quality of the NOL?

Sufficiency of post-closing cash flow

Will a future buyer ascribe value to the NOL?

Implications of valuation allowance

- Does it suggest diminished value?
- Are the projections to support consistent with management’s EBITDA?

## How Fast Can Benefits Be Achieved?

What limitations will apply to the NOL?

- Section 382
- NUBIG/NUBIL
- Corporate contraction implications

Ability to carryback a pre-closing loss & file for refund?

## Consolidated Return Considerations (attribute reduction)

§1.1502-36(d)

§1.1502-95(c)

16



# Transaction Deductions: Buyer vs. Seller Considerations

---

**Common Transaction Deductions:**

- Equity compensation (e.g., cash out of vested stock options).
- Change in control bonus payments.
- Advisor fees.
- Banker fees.

**What is the Tax Treatment of Transaction Deductions?**

- Section 83.
- Section 162 versus Section 263.

**What Tax Period Are Transaction Deductions Reported?**

- Pre-close short period.
- Post-close period.
- Treas. Reg. 1.1502-76 implications (next day rule).

**Who Gets the Economic Value of Transaction deductions?**

- Sellers often ask to be paid.
- Buyer may need to waive carryback period or refund may belong to the Seller (applicable in carve-outs).
- Amending a pre-closing return subjects the Seller to increased exposure.

**Working Capital Mechanism**

- Do the mechanics achieve the parties' objectives?

## Purchase Agreement Considerations

## Overview of Purchase Agreements: Key Elements

---

### Transaction Structure & Payment Mechanism

### Purchase Price & Adjustment Provisions

### Representations & Warranties

### Covenants & Conditions to Closing

### Indemnity / Escrow

### Post-closing Responsibilities

19

## Purchase Agreements: Transaction Structure & Purchase Price

---

### Transaction Structure & Payment Mechanism

- Form consistent with parties' intent & understanding?
- Definition of Included & Excluded Assets & Liabilities.
- Seller Rollover (in private equity deals).
- Withholding taxes.

### Purchase Price & Adjustment Provisions

- Working Capital (adjusts purchase price to the extent closing working capital differs from the target working capital or "peg").
  - Current vs. deferred tax.
  - Interaction with Indemnity.
- Allocation of tax benefits from transaction deductions (e.g., options, advisor fees).
- Purchase of cash / foreign cash.
- Transfer Taxes.

20

## Overview of Purchase Agreements: Reps & Warranties

---

### **Purpose**

- Diligence function.
- Indemnification.

### **Matters Covered**

- Tax Compliance (Filing & Payment).
- Corporate Structure and Filing Status (e.g., consolidated returns, S status).
- Tax Attributes (e.g., NOLs / Basis).
- Audit Status.
- Special Situations / Industry Specific Matters (e.g. FIRPTA).

### **Made at Signing / Re-affirmed at Closing**

### **Survival**

- Typically negotiated by parties.
- Buyer favorable - survive through the statute of limitations plus a reasonable period (30 – 60 days).
- Public-to-public deals – reps and warranties don't survive closing.

### **Qualifiers (Knowledge & Materiality)**

21

## Overview of Purchase Agreements: Covenants

---

### **Covenants Limit or Require Certain Actions Between Signing and Closing to Protect Buyer Before Buyer is in Control**

- Pre-closing structuring.
- Stripping of cash.
- 280G.
- Conduct of audits.
- Filing of returns.
- Changes in accounting methods / Elections.
- Termination of Tax Sharing Agreements.

22

## Overview of Purchase Agreements: Indemnities

---

### **Indemnifies Buyer for**

- Pre-closing & Straddle Period taxes (stand alone).
- Breaches of Representation.
- Taxes of another (e.g., 1.1502-6, transferee).

### **Ceilings and Floors on Claims**

### **Interplay with Working Capital / Taxes on the Balance Sheet**

### **Time for Asserting Claim**

23

## Overview of Purchase Agreements: Allocation of Post-Closing Obligations

---

### **Return Filing**

### **Audit Defense**

### **Carryback Claims**

### **Refunds**

24

## Acquisition Structures & Related Tax Benefits

## Taxable Transaction Structures

# Direct Asset Purchase

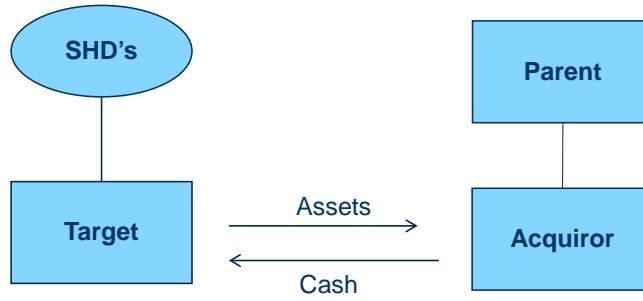

**A's Perspective:**

- A entitled to cost basis in assets acquired.
- Purchase price allocation under Section 1060.
- Corporate attributes & income tax exposures do not carry over.
- No carryover of E&P.
- Ability to choose which assets to acquire and which liabilities to assume.
- Transfer of each asset required (re-registration).
- Transfer taxes.

**Seller/T's Perspective:**

- Double Taxation (if proceeds are distributed to shareholders).
- Historic T liabilities remain with Seller/T.
- Historic Attributes remain with T.
- Transfer taxes.

27

# Deemed Asset Purchase

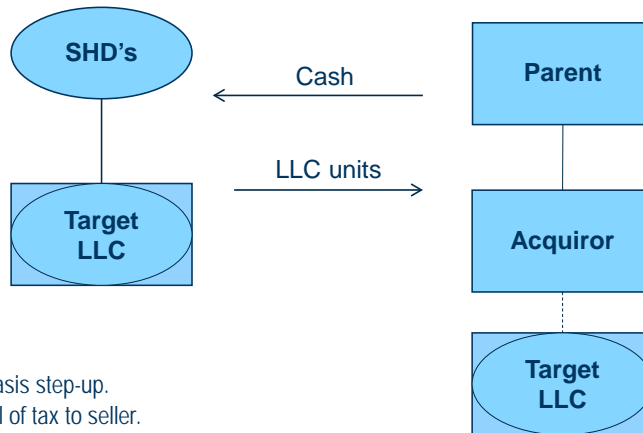

**Benefits:**

- Acquiror obtains basis step-up.
- Generally one level of tax to seller.
- Preserves corporate veil.
- Transfer taxes reduced or eliminated.
- No need to transfer assets or modify existing customer/vendor agreements.

28

## Asset Purchase Through Forward Cash Merger Transaction

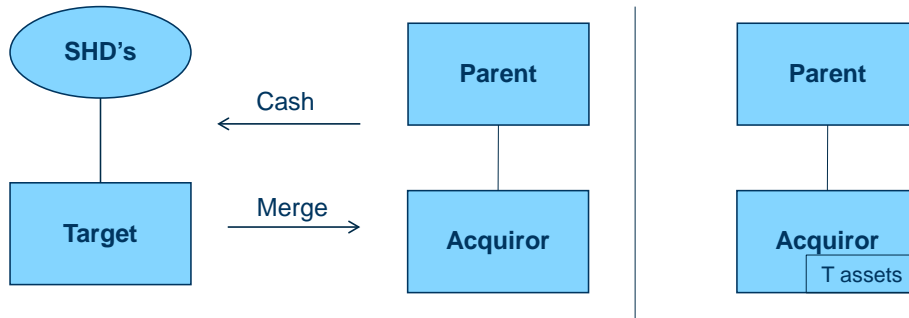

### Benefits:

- Acquiror obtains basis step-up.
- Preserves corporate veil.
- Transfer taxes reduced or eliminated.
- Assets transfer by operation of law.

### Costs:

- Double Taxation.
- Acquiror succeeds to all Target liabilities.
- Target tax attributes extinguish (but Target can use its attributes to reduce gain/taxes triggered upon merger).

29

## Asset Acquisitions: Section 1060 – Allocation of Purchase Price

### Why is the Purchase Price Allocation Important?

- Impact to **Buyer's basis** (and future tax deductions) and
- Impact on **Seller's gain or loss**.

### Section 1060

- Requires the **Residual Method** where there has been an "**applicable asset acquisition**" (i.e. a taxable acquisition) of a "**trade or business**" (**defined under treas. reg. 1.1060-1(b)(2)**).
- Both parties must complete **Form 8594** & file with return.

### Agreements Between the Parties

- Parties do not need to agree but it's **good practice**
- Form 8594 asks & the **IRS may match**.
- Agreement is binding on the parties but not on the IRS.
- Consider bolstering with a third party valuation.

30

# Asset Acquisitions: Contingent Liabilities & Purchase Price

## Contingent Liabilities and Purchase Price Are Taken Into Account for Basis Purposes When They Are Properly Taken Into Account Under General Principles of Tax Law.

- Impact to Buyer:
  - If Buyer assumes a contingent liability of Seller, it is treated as additional purchase price but Buyer doesn't get basis credit until either the liability is paid or it becomes sufficiently fixed and determinable.
- Impact to Seller:
  - Seller may elect installment method under Section 453 which provides special rules for contingent payment installment sales.
  - If Seller does not elect installment method, it must include the amount of the liability (determined by probability weighting and present valuing the contingent liability) into its amount realized in the year of the sale.
  - Potential for open transaction treatment to defer inclusion into amount realized is available in "rare and extraordinary circumstances".

31

## Taxable Stock Acquisition

Form: A Purchases T Stock From Seller for Cash and / or Notes

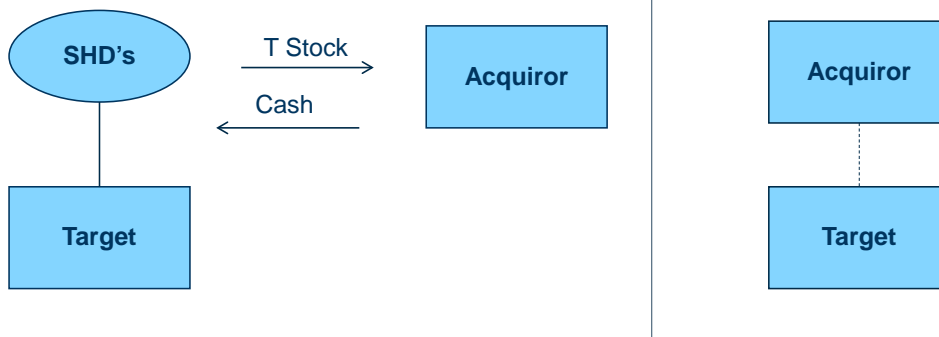

Seller/T's Perspective:

- Seller recognizes gain/(loss) on sale.
- T does not recognize gain/(loss).

A's Perspective:

- Acquiror takes cost basis in T shares purchased.
- T's basis and holding period in its assets remains unchanged.
- T's tax attributes remain with T subject to Sections 382 and 383.

32



# Taxable Stock Acquisition

Form: Reverse Subsidiary Cash Merger

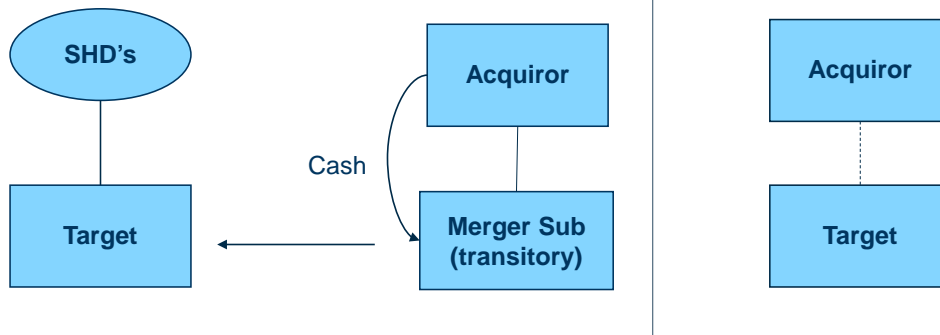

Seller/T's Perspective:

- Seller recognizes gain/(loss) on disposition of Target shared in the merger.
- T does not recognize gain/(loss).

A's Perspective:

- Acquiror takes cost basis in T shares purchased.
- T's basis and holding period in its assets remains unchanged.
- T's tax attributes remain with T subject to Sections 382 and 383.

# Taxable Stock Acquisition: Leveraged Buyout

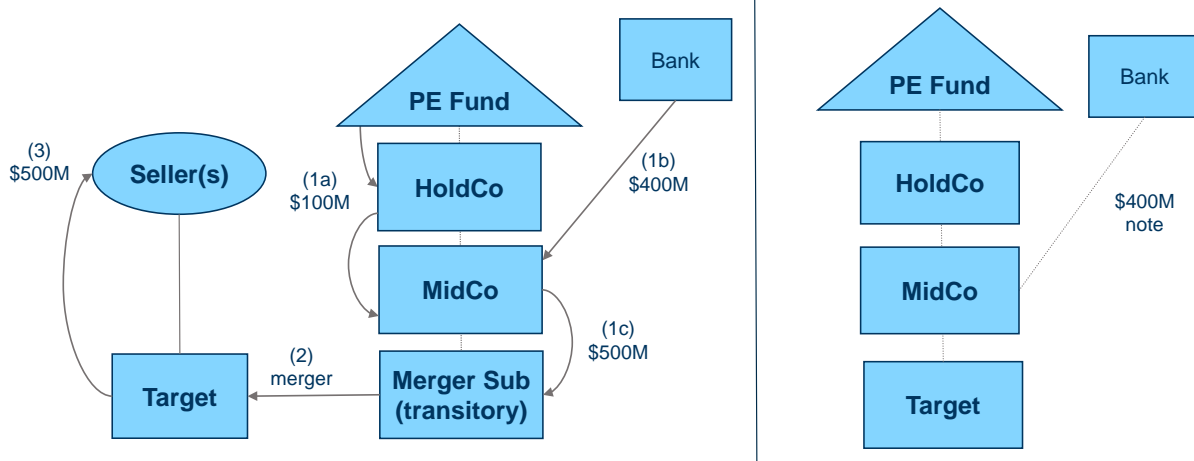

Results to Buyer:

- Cost/investment basis in HoldCo shares.
- T's basis in assets remains the same (i.e., no step-up).
- Pre-closing Tax Exposures / Liabilities carryover.
- T's attributes (e.g., NOLs) subject to limitations (e.g., Section 382).

Results to Seller:

- Seller recognizes capital gain / (loss) on sale.
- T does not recognize gain / (loss).

## Section 338 Elections: Overview

---

### Permits Asset Purchase Treatment Where Legal Form is a Stock Purchase

- Typical fact patterns when applicable.
  - Target is an S corporation or an 80% or greater corporate subsidiary member of a consolidated group, (§338(h)(10)).
  - Target has substantial losses, (§338(g)).
  - Target is a foreign corporation, (§338(g)).
- Requirements.
  - Qualified Stock Purchase (§338(d)(3)).
  - Timely filed Section 338 Election.
  - Timely filed Notice to US shareholders of a foreign target.

35

## Section 338 Elections: §338(g) vs. 338(h)(10) Election

---

### §338(g) Election is Made Unilaterally by The Purchasing Corporation

- Buyer must be a US or foreign corporation.
- Seller can be a US or foreign corporation, individual, partnership or trust.
- Target must be a US or Foreign Corporation.

### §338(h)(10) election is made jointly by the purchaser and seller

- Buyer must be a US or Foreign Corporation.
- Seller must be a US consolidated group, a “selling affiliate” or S corporation shareholder.
- Target must be a member of a consolidated group or a “target affiliate” or an S corporation.

36

## Section 338 Elections: Qualified Stock Purchase Elements

---

### QSP Elements

- Corporate Buyer.
- Purchase at least 80% (vote & value) of the stock of another corporation.
- In one or a series of transactions.
- Within a 12 month period.
- Buyer and Seller must not be related (See Section 338(h)(3)(B)).

### Tiered Targets

- Elections down a chain of targets
- Deemed QSP for lower-tier targets

37

## Section 338 Elections: §338(g) General Consequences

---

### Results to Target Shareholders

- Selling shareholders are treated as selling their stock.
  - Gain/loss on the sale is generally treated as capital gain.
  - Gain on sale of foreign target stock may be recharacterized as a dividend under Section 1248 (See Treas. Reg. §1.338-9).

### Results to Target

- T (Old T) is treated as having sold all of its assets at the close of the acquisition date (at their FMV) to unrelated “New T” in exchange for the consideration paid for Target’s stock plus New T’s assumption of Old T’s liabilities.
- Old T recognizes gain or loss on the deemed asset sale.

### Results to Buyer

- New T is treated as purchasing Old T’s assets as of the beginning of the day after the acquisition date.
- New T gets stepped up basis in the assets deemed purchased.
- T’s tax attributes (e.g., NOLs and E&P) disappear.

38

## Section 338 Elections: §338(g) General Observations

---

### **Economic Cost Falls on Buyer**

- However, where the target is a CFC, a selling US Shareholder may be impacted (See Treas. Reg. §1.338-9).

### **Generally Not Feasible in the Context of a US Target Because it May Result in Current Double Taxation.**

### **Two situations Where a §338(g) Election May Make Sense:**

- Target has significant net operating loss carryovers (NOLs) that would otherwise expire.
- Foreign Targets (depending upon results of Section 901(m) modeling).

39

## Section 338 Elections: §338(g) Election and NOL Usage

---

### **Use of T's NOLs to Offset T's Gain**

- Old T's NOL may be used without regard to any section 382 limit triggered on the sale of the stock.
- Need to Consider AMT.

### **Use of Buyer's NOLs to Offset T's Gain?**

- Not Permitted - See Section 338(h)(9).

40

# Section 338 Elections: §338(g) Election and Foreign Targets

---

**Benefits to Buyer**

- Creates a “hyped” FTC rate through increased depreciation and amortization.
  - However, benefits have been reduced by §901(m).
- Eliminates target’s attribute history (e.g., E&P & basis).
  - Note: historic basis is needed for §901(m) computations.
- Facilitates post-acquisition restructuring.
- Eliminates pre-acquisition subpart F.
- Reduces prospective subpart F through additional amortization and depreciation.

**Impact to US Shareholders of CFCs (Treas. Reg. §1.338-9)**

- May have §1248 or subpart F consequences for US selling shareholders.

# Section 338 Elections: §338(h)(10) General Consequences

---

**Tax Fiction:**

- Target “Old T” is treated as selling its assets to unrelated “New T” for the consideration paid for T stock plus New T’s assumption of Old T’s liabilities. Old T is then treated as liquidating into S.
- No gain or loss on the liquidation.
- Attributes flow up under §381 (where S is a C corp) assuming T is solvent.

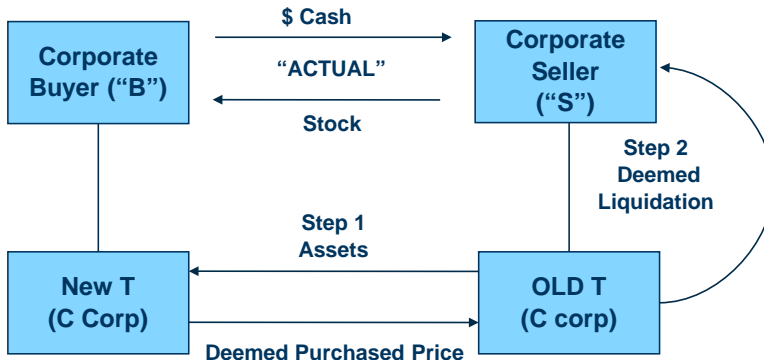

# Section 338 Elections: §338(h)(10) General Observations

## Buyer

- Tax basis step up in target assets.
- Future amortization & depreciation of stepped up assets.
- Takes the form of a stock sale for non-tax reasons.
- Note: historical business & tax exposures carryover.

## • Seller

- May be additional “incremental” taxes (federal + state) – for which seller may require a “gross up”.
- Iterative calculation.
- Complications with rolling shareholders – rollover is taxable as if stock was sold.
- Single level of tax (no shareholder level gain).
- Selling group may succeed to T’s attributes.

43

# Section 338 Elections: §338(h)(10) Example

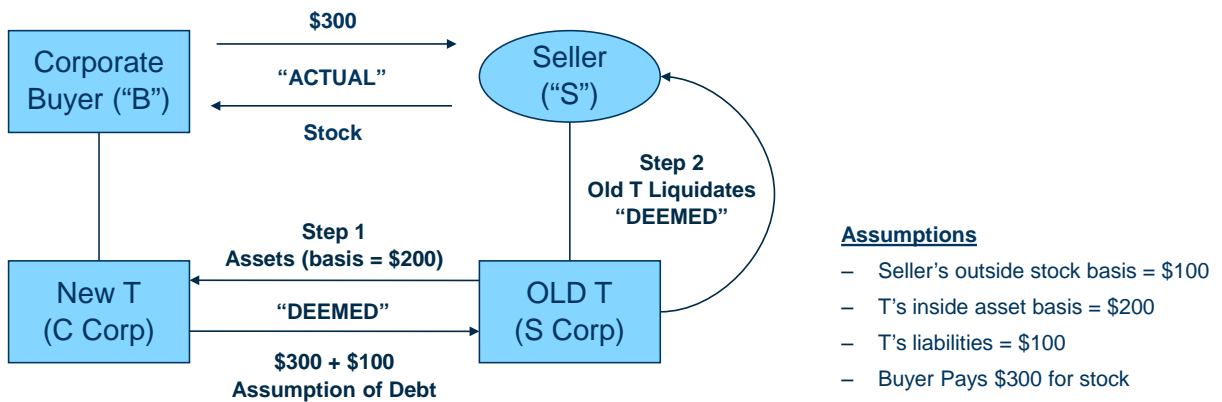

	Stock Sale	338(h)(10)
<b>Buyer “B”</b>	Cost Basis in T Stock = \$300	Cost Basis in T Stock = \$300
<b>Seller “S”</b>	Capital Gain = \$200	Capital / Ordinary Gain = \$200 (\$300 + \$100 - \$200) on deemed sales is passed through from Target; No gain on liquidation
<b>Target “T”</b>	No Gain; Carryover Basis	Gain passed through to S; Basis is stepped up to \$400

44

## Section 338(h)(10) Elections: Other Complicating Factors

---

### **Purchasing Corporation Must be Unrelated to the Seller**

- Rollovers where the Seller ends up with more than 20% are generally not good QSPs.
- Purchases that are part of Section 351 transactions (“boot”) don’t qualify as part QSP.
- Where the purchase occurs as part of a series of transactions, “relatedness” is tested after the last transaction in the series.

### **S Corp Status Must be Valid as a 338(h)(10) Can’t be Made on a Stand Alone “C” Corp**

#### **Inside ≠ Outside Basis**

- Typically arises where T stock was previously purchased with no 338(h)(10) election.

#### **Built-in Gains Taxes (S corporations)**

#### **Gross-up for Incremental Taxes**

- Recapture (ordinary vs. capital gain).
- State taxes.

45

## Section 338 Elections: Compliance Requirements

---

### **Section 338 Election and Notice Requirements:**

- A 338 election is made on Form 8023.
  - Must be made not later than the 15th day of the 9th beginning after the month in which the QSP occurs.
- Notice to US Shareholders of CFC Target.
  - Must be delivered to the US person on or before the later of the 120th day after the acquisition date or the day on which Form 8023 is filed.

### **Compliance Requirements:**

- Form 8883 used by Buyer/Target and Seller to report results of Section 338 election.
  - Seller reports Adjusted Deemed Sales Price (as determined under Treas. Reg. §1.338-4).
  - Buyer reports Adjusted Grossed-up Basis with respect to Target (as determined under Treas. Reg. §1.338-5).
- Section 338(g) Election.
  - Form 8883 attached to Buyer’s US federal income tax return for the tax year in which the QSP occurs.
- §338(h)(10) Election.
  - Form 8883 attached to Buyer’s and Seller’s US federal income tax return for the tax year in which the QSP occurs.

46

## Deemed/Actual Asset Acquisitions: Residual Method

---

### **Residual Method Allocates Purchase Price Among 7 Asset Classes (See Treas. Reg. 1.1060-1(c)(2) Referencing Treas. Regs. 1.338-6 and 1.338-7)**

- Class I - Cash & Deposit Accounts.
- Class II – Actively Traded Personal Property (e.g., government securities, publicly traded stock, CDs & foreign currency).
- Class III – Assets that T marks to market and debt instruments including accounts receivable
  - Excludes related party, contingent, or convertible debt.
- Class IV – Inventory
- Class V – All other assets not included in Classes I, II, III, IV, VI & VII. Examples include:
  - Furniture & Fixtures, Land, and Equipment, Stock in Subsidiaries.
- Class VI – All section 197 Intangibles except for goodwill & going concern value.
- Class VII – Goodwill & Going Concern Value.

47

## Deemed/Actual Asset Acquisitions: Allocation Rules

---

### **Residual Method Allocates Purchase Price Among 7 Asset Classes (See Treas. Reg. 1.1060-1(c)(2) Referencing Treas. Regs. 1.338-6 and 1.338-7)**

- Residual method is described in Treas. Reg. 1.338-6.
- Reallocation of the purchase price for subsequent adjustments is described in Treas. Reg. 1.338-7.
- Purchase price is allocated successively to each asset class.
- The amount allocated to any asset may not exceed its FMV.
- If the purchase price allocated to a class is insufficient to fully allocate to all the assets, then it is allocated to each asset proportionately to their FMVs.
- If an asset can be included in more than one class, then choose the lower numbered class.

48



## Deemed/Actual Asset Acquisitions: Differences Between Tax Reporting under IRC 1060 and Financial Reporting Under GAAP

---

### Purchase Price and Standard of Value Differences

- Tax Reporting:
  - Fair Market Value definition from Revenue Ruling 59-60 (Hypothetical Willing and Able Buyer and Seller Concept).
  - Includes certain transaction costs in purchase price.
  - Deferred Taxes not included in purchase price.
  - Debt measured at Face Value.
- Financial Reporting:
  - Fair Value definition from Accounting Standards Codification (“ASC”) 820, formerly Statement of Financial Accounting Standards (“SFAS”) 157, *Fair Value Measurements* (Market Participant Concept).
  - Excludes transaction costs in purchase price.
  - Deferred Taxes are included in purchase price.
  - Debt measured at Fair Value.

49

## Deemed/Actual Asset Acquisitions: Differences Between Tax Reporting Under IRC 1060 and Financial Reporting under GAAP (cont'd)

---

### Allocation Differences

- Tax Reporting:
  - Allocation performed at the legal entity level.
  - Purchase Price allocated to the assets under the residual method as previously discussed.
  - All Intangible Assets are included as one class under the residual method.
  - Goodwill is amortized.
- Financial Reporting:
  - Allocation performed at the reporting unit level as defined in ASC 350, formerly SFAS 142, *Goodwill and Other Intangible Assets*.
  - All assets and liabilities assumed and any non-controlling interest in the Target must be recognized and measured at Fair Value.
  - Intangible Assets, such as technology, trademarks, customer relationships, and covenants not-to-compete, are separately recognized under ASC 805, formerly SFAS 141, *Business Combinations*.
  - Goodwill is not amortized, but tested for impairment under ASC 350.

50

## Acquisition Earnout: Compensation vs. Consideration

---

### Key Questions

- Tax Reporting:
  - Is the payment contingent upon employment or future services? Is other compensation reasonable?
  - Is the payment intended to be for the purchase of equity according to valuation and negotiations?
  - Is the payment proportional to the sale of equity?
- Financial Reporting:
  - Treatment for GAAP may differ from the tax treatment

51

Spin-Off Exits

# Strategic Rationale for Spin Transactions

## Unlocking hidden value and undiversification

- Divest non-core business and sharpen strategic focus on core business - allows for clear articulation of separate mission statement and strategy for a company's 'parts' – providing ease of valuation.

## Institutional sponsorship

- Promote equity research coverage and ownership by sophisticated institutional investors, each of which tend to validate the standalone business.

## Acquisition currency

- Stock of the standalone business may be viewed as more attractive acquisition currency to future target companies.

## Motivating management

- Improve performance by better aligning management incentives with the performance of the standalone business (e.g., through equity compensation), creating direct accountability to public shareholders, and increasing transparency into management performance.

## Eliminating dissynergies

- Reduce bureaucracy and give management of the standalone business complete autonomy.

## Sample value creators include:

- Aggressive, focused growth in revenue and profitability aligned with operating model.
- Differentiated allocation of capital to projects that align with shareholder value creation e.g. growth vs. dividend.
- Clear, effective communication of long-term strategy and roadmap to achieve, including forward looking EPS targets.
- Optimizing cash and managing liquidity and debt.
- Accessing cash in a tax-efficient structure.

53

# Comparison of Taxable Sale and Tax-Free Distribution

## Option #1: Sale of S stock

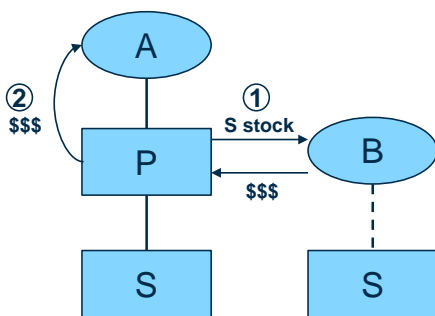

### Transaction steps:

- P sells all of the stock of S to an unrelated person for cash, and then distributes the after-tax sales proceeds to A

### Key federal income tax consequences:

- P recognizes *corporate-level gain* on any appreciation in the S stock
- The distribution is a *dividend* to the extent of P's E&P. The balance, if any, first reduces A's basis in P stock, and then is treated as gain from the sale or exchange of the P stock

## Option #2: Tax-free distribution of S stock

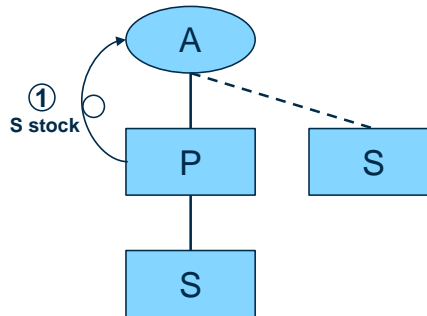

### Transaction step:

- P distributes all of the stock of S to A in a transaction that qualifies under §355

### Key federal income tax consequences:

- Provided that certain requirements are satisfied, no gain is recognized to, and no amount is included in the income of, P or S

54

# Applicable Provisions: “D/355” Transaction

**Transaction:** D transfers assets to C in exchange for C stock, securities, and boot. Then, in pursuance of the plan of reorganization, D distributes (1) all of the C stock with respect to A’s D stock, (2) all of the C securities in exchange for D securities held by A, and (3) the boot to A. Provided this transaction qualifies as a divisive reorganization under §§368(a)(1)(D) and 355 (a “D/355”), the following provisions govern the tax consequences to A, D, and C.

**Provisions applicable to A:**

- Same as in Straight 355

**Provisions applicable to D:**

- **§§ 361(a) and 357(a):** D recognizes neither gain nor loss on transfer of assets to C in exchange for C stock and C’s assumption of D’s liabilities
- **§361(b):** D recognizes no gain or loss on transfer of assets to C in exchange for boot, provided that such boot is distributed to A (or D’s creditors) in pursuance of the plan of reorganization
  - Note: *Generally*, D recognizes gain to the extent the boot distributed and liabilities assumed exceeds D’s basis in the C stock
- **§361(c):** D recognizes neither gain nor loss on distribution of C stock, securities, or boot to A (or D’s creditors) in pursuance of the plan of reorganization
- **§312(h) and Reg. §1.312-10(a):** Proper *allocation* of the E&P between D and C must be made

**Provisions applicable to C:**

- **§1032(a):** C recognizes neither gain nor loss on issuance of its stock in exchange for assets
- **§362(b):** C’s basis in each asset received from D will be the same as D’s basis in each such asset

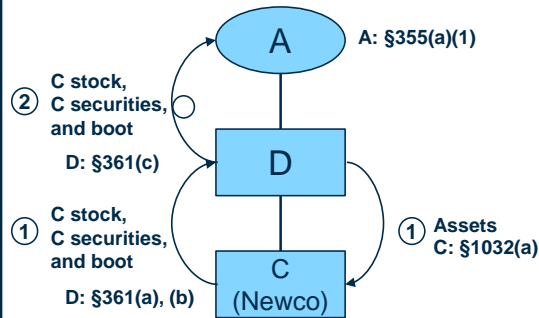

# Applicable Provisions: “Straight 355” Transaction

**Transaction:** D distributes to A (1) all of the stock of C and (2) money or other property (i.e., “boot”). Provided this transaction qualifies as under §355 (a “Straight 355”), the following provisions should govern the tax consequences to A, D, and C.

**Provisions applicable to A:**

- **§355(a)(1):** A recognizes neither gain nor loss on receipt of C stock distributed with respect to her D stock
- **§356(a):** Boot received by A is taxable under §356
- **§358 and Reg. §1.358-2(a)(2):** A’s basis in the D stock is allocated between the D and C stock in proportion to their fair market values
  - Note: Different basis results would obtain if A surrenders D shares in exchange for C shares (i.e., split-off)

**Provisions applicable to D and C:**

- **§355(c)(1):** D recognizes neither gain nor loss on distribution of C stock to A in pursuance of the plan of reorganization
- **§355(c)(2):** D recognizes gain on any appreciation in the boot distributed to A
- **§312(h) and Reg. §1.312-10(b):** Proper *adjustment* to the E&P of D and C must be made

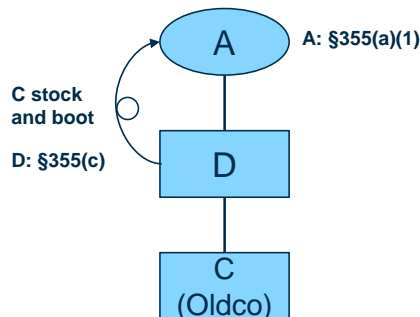

## Overview of Tax-Free Spin-Off Requirements

---

### **Section 355, tax regulations, and case law establish several requirements that must be met to effect a tax-free spin off, including:**

#### **– Statutory requirements**

- The distribution must be to shareholders or security holders of Distributing
- Distributing must “control” (generally 80% or more) SpinCo immediately before the distribution
- All the stock of SpinCo must be distributed
- The distribution cannot be used principally as a “device” to distribute earnings and profits of Distributing, SpinCo, or both
- The business being distributed must have been actively conducted for the 5-year years prior to such distribution (“Active Trade or Business Test”)
- Not subject to §355(d) or (e) corporate-level tax
- Not an investment company

#### **– Non statutory requirements**

- There must be a valid business purpose for the spin off
- D’s shareholders must retain continuity of interest in SpinCo
- SpinCo must continue the historical business enterprise

57

## Overview of Tax-Free Spin-Off Requirements (cont’d)

---

### **Applicable U.S. Cross-Border Tax Rules**

- Section 367(b) - Applies to any distribution in which the status of a foreign corporation as a corporation is relevant to Section 355 qualification (i.e., controlled and/or distributing is foreign).
  - US distributing – gain recognition is required with respect to stock distributed to individuals (rebuttable presumption of individual ownership of distributing).
    - Not applicable to the extent gain is recognized pursuant to Section 367(e).
  - Foreign distributing – potential basis reduction and income inclusion to the extent “predistribution amount” exceeds “postdistribution amount.”
- Section 367(e) - In a distribution of a foreign controlled corporation by a US distributing corporation to non-US person, the distributing corporation is required to recognize gain under principles of §367(a).
- Section 1248(f) - Gain realized upon distribution by domestic corporation of stock of a foreign corporation is treated as a dividend to the distributing domestic corporation to the extent FMV of controlled stock exceeds basis, subject to certain exceptions.
- FIRPTA - May apply where either the distributing or controlled corporation is a USRPHC.
- Section 367(a) and (d) may also apply in the case of a “D/355.”

**Currently, the Internal Revenue Service will only rule on “significant issues” with respect to certain requirements (e.g., the Active Trade or Business Test).**

58

## Basic Structures: Spin-Off

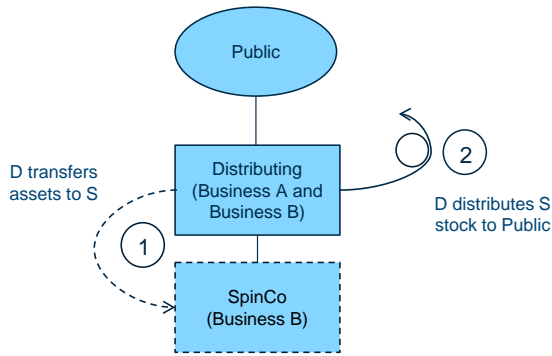

- A “Spin Off” is a pro rata distribution of the shares of a controlled corporation (“SpinCo” or “S”) to the shareholders of the distributing corporation (“Distributing” or “D”).

- If the requirements of Section 355 are satisfied, the transactions will be tax-free to D, S, and D’s shareholders.

- Note: SpinCo can be newly-formed or a pre-existing corporation

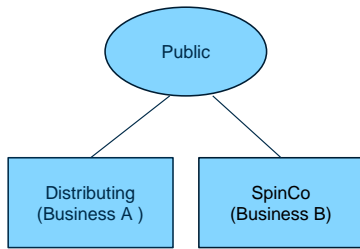

59

## Basic Structures: Split-Off

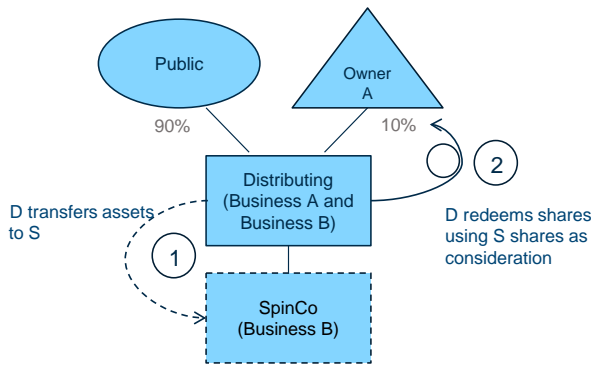

- In a “Split Off,” D redeems its own shares from one or more shareholders, using S shares as consideration in the redemption.

- While a split off may be done on a non-pro rata basis (as depicted to the left), it can also be done pro rata.

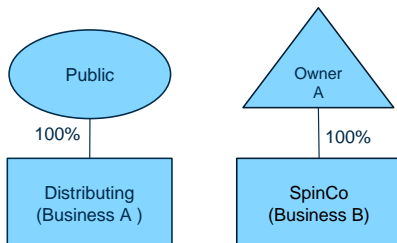

- Stock redemptions can facilitate a new or existing stock buy-back program by enabling stock repurchases without the use of cash.

60

# Basic Structures: Split-Up

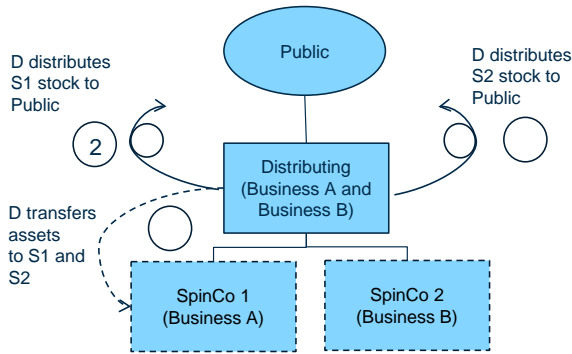

- In a "Split Up," D distributes two controlled corporations, S1 and S2. Each contains at least one separate trade or business. D liquidates after the distribution.

- While a split up may be done on a pro rata basis (as depicted to the left), it may also be non pro-rata.

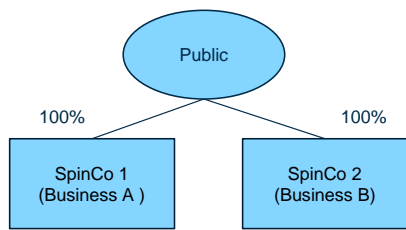

61

# Control Gathering Recap

## Pre-Recap

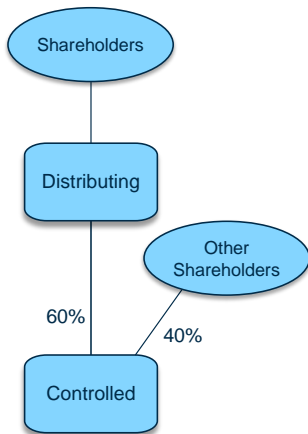

## Post-Recap

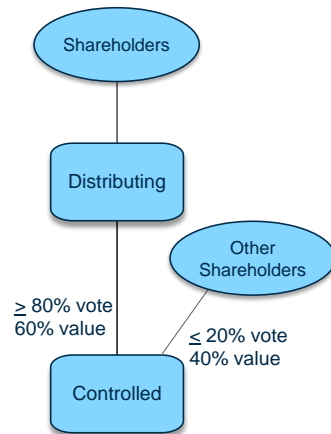

## Post-Spin-Off

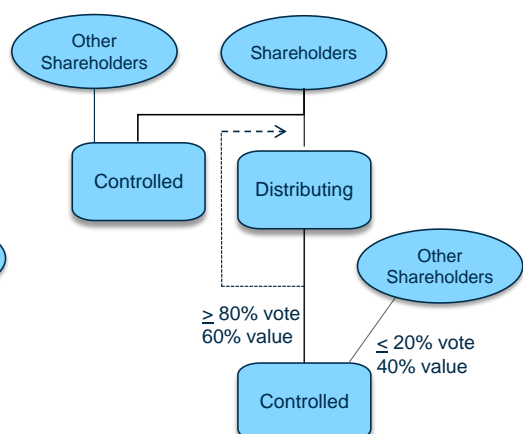

62

## Revenue Procedure 2016-40 Pre-Spin Control Gathering

---

- Confirms that pre-spin high vote/low vote recaps and other issuances by Controlled in which Distributing acquires 80% voting control of Controlled can pass muster.
- Two safe harbors under which IRS will not challenge recaps into control and subsequent unwinds:
  - No Change for 2 Years: Where no action is taken to effectuate unwind within 24 months of spin-off by Controlled's management, board or controlling shareholders, including adoption of any plan or policy; or
  - Unanticipated Transaction: Where Controlled engages in transaction (e.g., merger with 3<sup>rd</sup> party) resulting in unwind of high vote/low vote structure and there was:
    - No agreement, understanding, arrangement or substantial negotiations or *discussions* concerning the transaction during 24-month period ending on date of spin-off; and
    - No more than 20% (by vote or value and applying attribution rules) of the 3<sup>rd</sup> party is owned by persons that own more than 20% of Controlled.

63

## Methods of Extracting Value from SpinCo

---

Generally, there are five methods by which value can be extracted from a non-core business in connection with the separation of core and non-core operations (the first 3 of which are illustrated in the next slides).

1. S assumes liabilities: S assumes certain of D's liabilities;
2. S distributes cash: S distributes cash to D in connection with the distribution;
3. S issues securities: S issues securities (long-term debt) to D and D uses securities to satisfy historic D debt;
4. S issues stock: S issues stock to D and D uses S stock to satisfy historic D debt; and
5. Reverse direction spinoff: leverage the non-core business and spin the core business (together with the proceeds of leveraging).

64



## (1) SpinCo Assumption of Liabilities: Mechanics

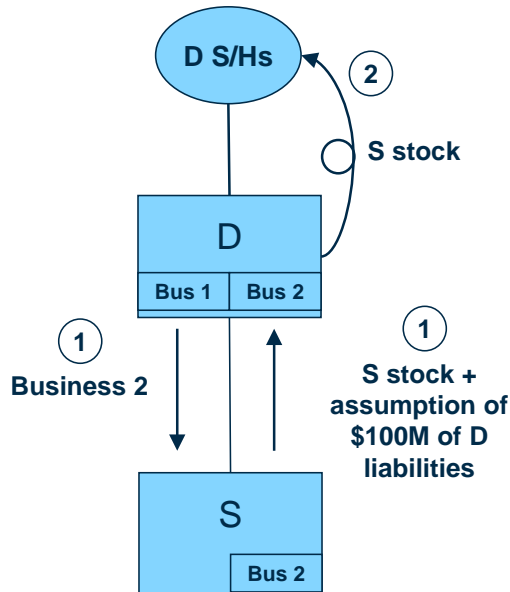

D owns Business 1 and Business 2. Business 2 has a tax basis of \$100M and a FMV of \$1B.

1. D transfers Business 2 to newly formed S in exchange for \$900M of S stock and S's assumption of \$100M of D's outstanding debt.
2. D distributes the stock of S to D shareholders in a distribution intended to qualify under Sections 355 and 368(a)(1)(D).

65

## (1) SpinCo Assumption of Liabilities: Limitations

- Assumed liabilities must be limited to the basis of the assets transferred by D to S.
- To the extent that the liabilities assumed exceed the basis in the transferred assets, D will recognize gain under Section 357(c).
- Section 357(c)(3) – May permit certain liabilities to be excluded from the computation:
  - If a taxpayer transfers, in an exchange to which Section 351 applies, a liability the payment of which either, (i) would give rise to a deduction, or, (ii) would be described in Section 736(a), then, the amount of such liability shall be excluded in determining the amount of liabilities assumed.
    - Section 357(c)(3) does not specifically reference an exchange pursuant to a Section 368 reorganization.
    - However, see PLRs 200501025, 200422018, and 200310005 (permitting the exclusion of Section 357(c)(3) liabilities in the context of a divisive “D” reorganization).

66

## (2) SpinCo Cash Distribution: Mechanics

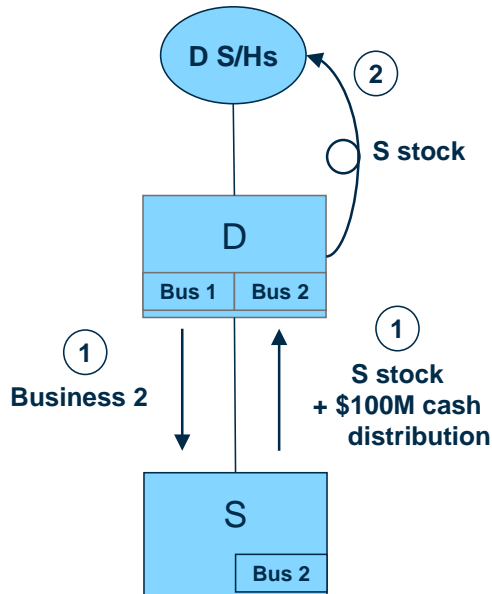

D owns Business 1 and Business 2. Business 2 has a tax basis of \$100M and a FMV of \$1B.

1. D transfers Business 2 to newly formed S in exchange for \$900M of S stock and \$100M cash (existing cash or debt funded cash or IPO funded cash).
2. D distributes the stock of S to D shareholders in a distribution intended to qualify under Sections 355 and 368(a)(1)(D).

67

## (2) SpinCo Cash Distribution: Limitations

- D may receive cash tax-free from a newly-formed S to the extent of the net basis of property that D transfers to S (basis of assets/stock transferred less liabilities assumed).
- To the extent that D receives S cash in excess of such net basis, D will recognize gain.

68

## (2) SpinCo Cash Distribution: Permitted Uses of Cash – In General

---

- Subject to the limitations discussed below, D generally must use the S cash to repay D indebtedness or make distributions to shareholders.
- There are numerous practical considerations and limitations regarding the use of the cash received in a spin-off, including:
  - Is cash required to be held in a segregated account, or is cash fungible (IRS rulings are inconsistent)?
  - How long can the cash be held before it has to be used (based on past experience, the IRS has allowed up to 18 months between receipt and distribution of cash)?
  - Does the cash have to be used to repay creditors that existed on the date of the spin, or can it be used to repay debt incurred after the spin (evolving IRS ruling policy)?
  - Can the cash be used to fund an existing stock buy back program (i.e., can the cash go out as part of the plan of reorganization if it is also used to fund a buy-back plan that existed before the spin was contemplated)?

69

## (2) SpinCo Cash Distribution: Permitted Uses of Cash – Repayment of D Debt

---

- Clearly permissible uses:
  - Repayment of historic D debt not incurred in connection with the spinoff.
- Other potentially permissible uses (subject to IRS confirmation):
  - Payment of consent fees to retire historic D debt.
  - Repayment of intercompany debt.
    - The counterparty must use the proceeds received to repay third-party debt within 12 months of the spinoff.
  - Repayment of D's ordinary course liabilities (e.g., trade payables).

70

### (3) SpinCo Securities Exchange: Mechanics

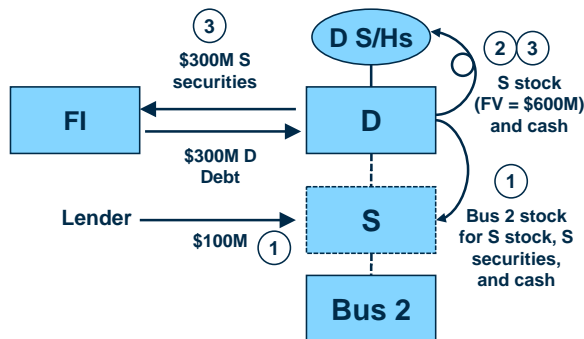

D owns Business 2. Business 2 has a FMV of \$1B and an aggregate tax basis of \$100M.

#### Steps

1. D transfers Business 2 to a newly formed S in exchange for \$100M of cash (debt funded), \$300M of S securities (long term debt), and \$600M of S stock.
2. D uses the \$100M of cash in accordance with the rules for a Controlled Cash Distribution.
3. D transfers the S securities to financial institution (FI) in exchange for \$300M existing D owed to FI\* and distributes the S stock to D's shareholders in a distribution intended to qualify under Sections 355 and 368(a)(1)(D).

\*Alternatively, FI may acquire existing D debt in the marketplace

4. FI sells the S securities for cash in a public offering.

71

### (3) SpinCo Securities Exchange: Limitations

- Under current law, the amount of S securities issued in exchange for D's assets is not basis limited and there are no limitations on the use of the cash.
- Limitations:
  - Debt-equity (i.e., the S securities must constitute bona fide debt, not equity, for US federal income tax purposes).
  - The S securities must constitute a security for subchapter C purposes.
  - PLR 201721002 ruled that provided Distributing debt exchanged (or other Distributing debt in satisfaction of which Controlled debt is distributed) constitutes "securities" for purposes of sections 355 and 361, and the Controlled debt to be transferred in cancellation of the Distributing debt has comparable terms (e.g., comparable remaining period to maturity, but not necessarily comparable interest rate), Controlled debt will constitute "securities" for purposes of sections 355 and 361 under the principles of Rev. Rul. 2004-78. See also PLR 201537004.

72

## Coordination Across Multiple Workstreams

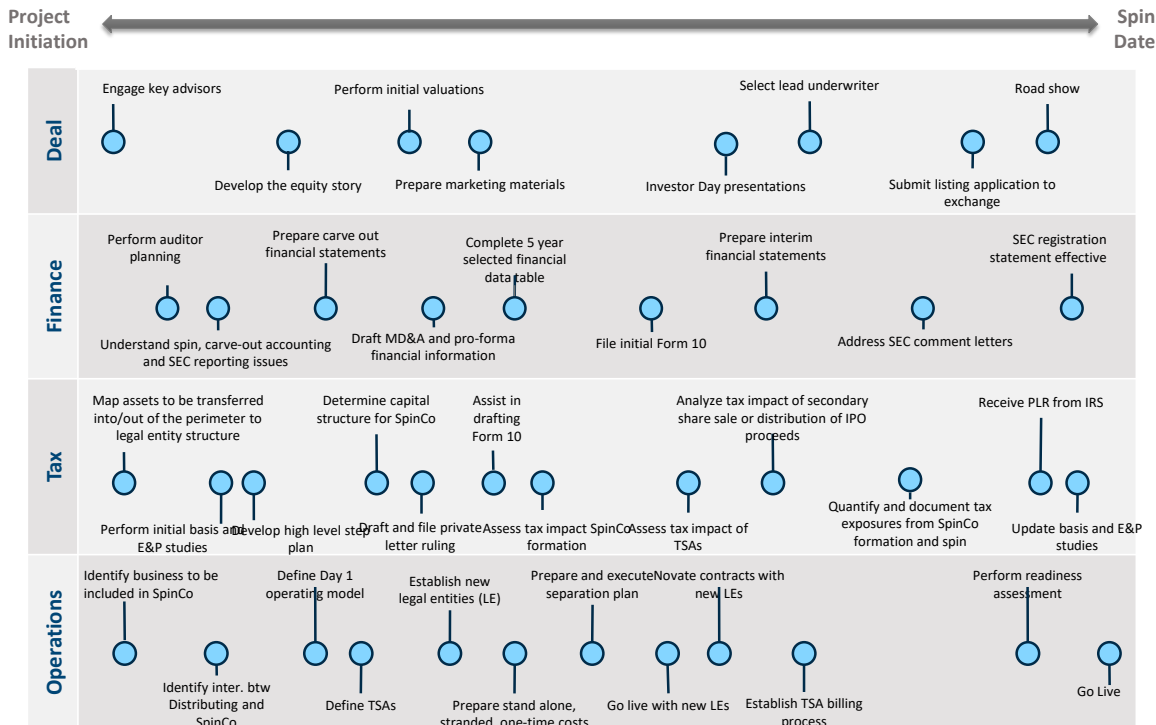

73

## Section 355(e): Why Should Acquirer Worry?

Corporate Tax on Controlled Gain. Distributing (but not its stockholders) is taxed under Section 355(e) if an otherwise tax-free spin-off is part of a plan for 3<sup>rd</sup> party to acquire 50% or more of the Distributing or Controlled.

- Rebuttable statutory presumption that acquisition of 50% or more of voting power or economic value of Distributing or Controlled stock is part of a plan triggering Section 355(e) if it occurs within 2 years before or 2 years after the spin-off.
- Types of transactions that may contribute to or result in a transfer of 50% or more for purposes of Section 355(e) include issuances of stock by Distributing or Controlled in public offerings or acquisition transactions, as well as acquisitions of Distributing or Controlled by 3<sup>rd</sup> parties. Issuances of options or stock to employees generally are not included in the 355(e) analysis.
- Section 355(e) rules apply to certain successors and predecessors of Distributing and Controlled, such that under certain circumstances, acquisitions of stock of other corporations may be relevant to the 50% or more test.

74

## Section 355(e): Why Should Acquirer Worry? (cont'd)

---

Distributing's Legal Liability. But typically allocated to Controlled by contract, if Controlled's actions create liability.

Acquirer Concerns. Potential acquirers and strategic partners of Distributing or Controlled will tend to be conservative in analysis of whether proposed post-spin-off transaction could trigger Section 355(e) liability, since acquirer typically would inherit liability.

75

## Safe Harbors for Post-Distribution Acquisitions & Issuances

---

In General: Safe harbors relax 2-year presumptions and may provide flexibility to enter into certain unplanned acquisition transactions. Key factors affecting applicability of safe harbors include the timing of negotiations and business purpose for spin-off.

"Super Safe Harbor": Except in the case of a public offering, a post-distribution acquisition can be part of a plan only if there was an agreement, understanding, arrangement or substantial negotiations regarding the acquisition or a similar acquisition at some time during the two-year period ending on the date of the distribution.

- Base case for Super Safe Harbor is where Distributing has had no contacts with the eventual acquirer regarding an acquisition for more than two years pre-spin.
- Assumes substantial business purpose for spin-off unrelated to any potential acquisition.
- Substantial negotiations involve discussion of significant economic terms by officers, directors, controlling shareholders or other persons with implicit or explicit permission to engage in such discussions.
- Super safe harbor is not available for post-spinoff public offerings.

76

## Safe Harbors for Post-Distribution Acquisitions & Issuances (cont'd)

---

One-Year Safe Harbor: A post-distribution acquisition will not be considered part of a plan if there was no agreement, understanding or arrangement regarding the acquisition or a similar acquisition at the time of the distribution, and there was no agreement, understanding, arrangement or substantial negotiations regarding the acquisition or a similar acquisition within one year after the distribution.

- Pre-distribution negotiations without reaching an agreement , understanding or arrangement should not compromise the spin-off, provided that there are no negotiations for one year post-spin.
- Distributing and Controlled generally could not re-engage with potential acquirers with which there were substantial negotiations pre-spin for one-year period post-spin.

77

## Safe Harbors for Post-Distribution Acquisitions & Issuances (cont'd)

---

- 18-Month Safe Harbor: A post-distribution acquisition will not be considered part of a plan if:
  - spin-off was motivated in whole or substantial part by a business purpose other than to facilitate acquisition,
  - acquisition occurs more than six months after spin-off, and
  - there was no agreement, understanding, arrangement or substantial negotiations regarding the acquisition or a similar acquisition during the period beginning one year before and six months after the spin-off.

78

## Safe Harbors for Post-Distribution Acquisitions & Issuances (cont'd)

- Other safe harbors protect acquisitions of stock of Distributing or Controlled before the spin-off is disclosed.
- Public trading of Distributing or Controlled stock by unrelated small stockholders generally is not taken into account for any of the safe harbors.
- Stock issued to service providers and small issuances to certain retirement plans generally is not taken into account for any of the safe harbors.

79

## Basic Structures: Reverse Morris Trust Transaction

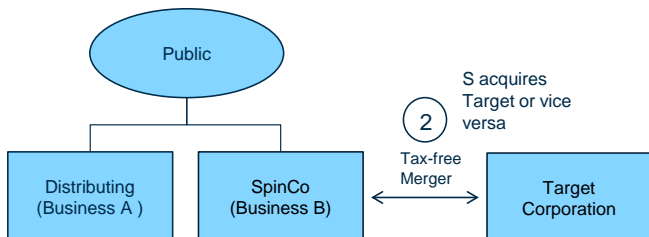
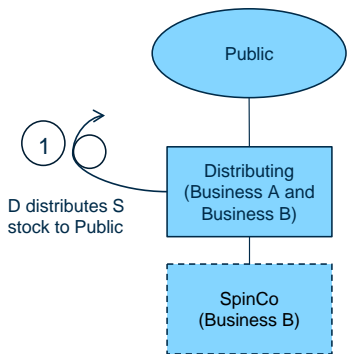

- A “Reverse Morris Trust” transaction involves two steps:
- Step 1: D distributes shares of S to its shareholders
- Step 2: S acquires Target (or Target acquires S) in a tax-free merger.
- For a Reverse Morris Trust Transaction to be respected as a tax-free spin followed by a tax-free merger, D’s public shareholders should retain more than 50% of the merged company.

80



## Safe Harbors for Post-Distribution Acquisitions & Issuances (cont'd)

---

### Safe Harbor Cheat Sheet

<u>Timing of Substantial Negotiations</u>	<u>Safe Harbor for Post-Spin Transaction</u>
Never	Immediately after spin-off
More than 2 years prior to spin-off	Immediately after spin-off
Between 1 and 2 years prior to spin-off	No [substantial] negotiations for 12 months prior to and 6 months after spin-off
Less than 1 year prior to spin-off	No [substantial] negotiations for 12 months after spin-off

81

## Appendix Certain Tax-Free Transaction Structures

## Certain Types of Tax-Free Acquisitions

Asset	Stock
Type A Forward Triangular Merger Type C Section 351	Type B Reverse Triangular Section 351

83

Type of Reorganization	Consideration Permitted	% Stock Required	"Substantially All" Requirement	Target Survives	Limited Liability to Acquirer	Vote of Acquirer Shareholders	Asset Transfer Required	Continuity of Interest Required	Continuity of Business Enterprise Required	Business Purpose Required
Type "A" Reorganization	Stock plus other	40%	No	No	No	Yes	No	Yes	Yes	Yes
Forward Subsidiary Merger	Stock of parent plus other	40%	Yes	No	No	No <sup>3</sup>	No	Yes	Yes	Yes
Reverse Subsidiary Merger	Voting stock of parent plus other	80%	Yes	Yes	Yes	No <sup>3</sup>	No	Yes	Yes	Yes
Type "B" Reorganization	Voting Stock	100%	No	Yes	Yes	No <sup>3</sup>	No	Yes	Yes	Yes
Type "C" Reorganization	Voting Stock <sup>1</sup>	100%	Yes	No	Yes <sup>2</sup>	No <sup>3</sup>	Yes	Yes	Yes	Yes
Type "D" Reorganization	Stock plus other	0% <sup>4</sup>	Yes	No	Yes <sup>2</sup>	No <sup>3</sup>	Yes	Maybe <sup>5</sup>	Yes	Yes
Type "F" Reorganization	Stock plus other	99%	No	No	No	No <sup>3</sup>	No	No	No	Yes

<sup>1</sup> Technically, up to 20% non-stock consideration is permitted in a C organization. However, if non-stock consideration is used, assumed liabilities will count against the 20% cap. Therefore, in practice, no non-stock consideration can be used in most transactions.

<sup>2</sup> Acquirer may be liable for some or all of Target's liabilities under common law doctrines (e.g., de facto merger doctrine)

<sup>3</sup> Vote may be required if stated in Acquirer's charter, to authorize an issuance of stock, or, subject to the varying rules of the different stock exchanges, if stock to be issued represents more than 20%.

<sup>4</sup> A transaction may qualify as a type "D" reorganization notwithstanding the fact that no actual shares of acquirer stock are issued provided the transaction satisfies the control and other requirements of a "D" reorganization. See Treas. Reg. § 1.368-2(l).

<sup>5</sup> Based upon the legislative history underlying the COI regulations, COI requirement arguably does not apply. However, various rulings and case law suggest otherwise. See Rev. Ruls. 70-240, 2004-83 and 75-383.

## Asset Reorganizations: Type A

### Statutory Merger or Consolidation

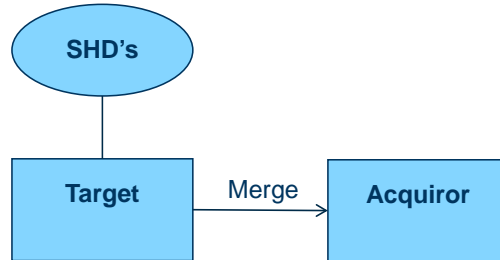

### Federal Tax Fiction

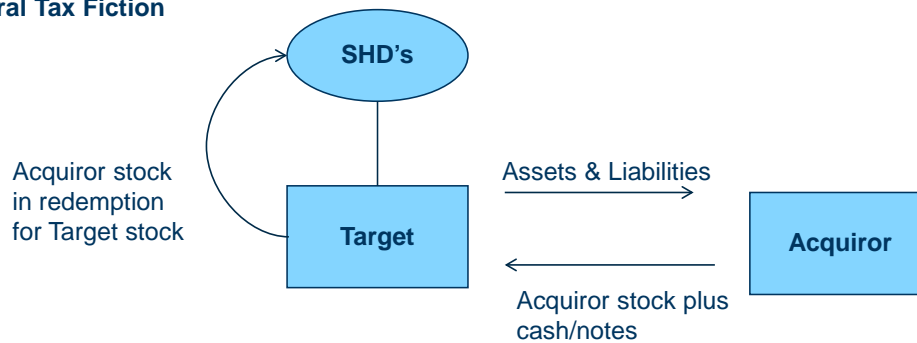

85

## Asset Reorganizations: Type A (cont'd)

### General

- Can be effected with domestic, foreign and disregarded entities.
- Up to 60% boot permitted.

### Other Considerations

- Assets transfer by operation of law.
- Generally avoids acceleration of contractual provisions.
- Avoid transfer taxes.
- Allows for squeeze-out of minority shareholders.

86

## Asset Reorganizations: Forward Subsidiary Merger

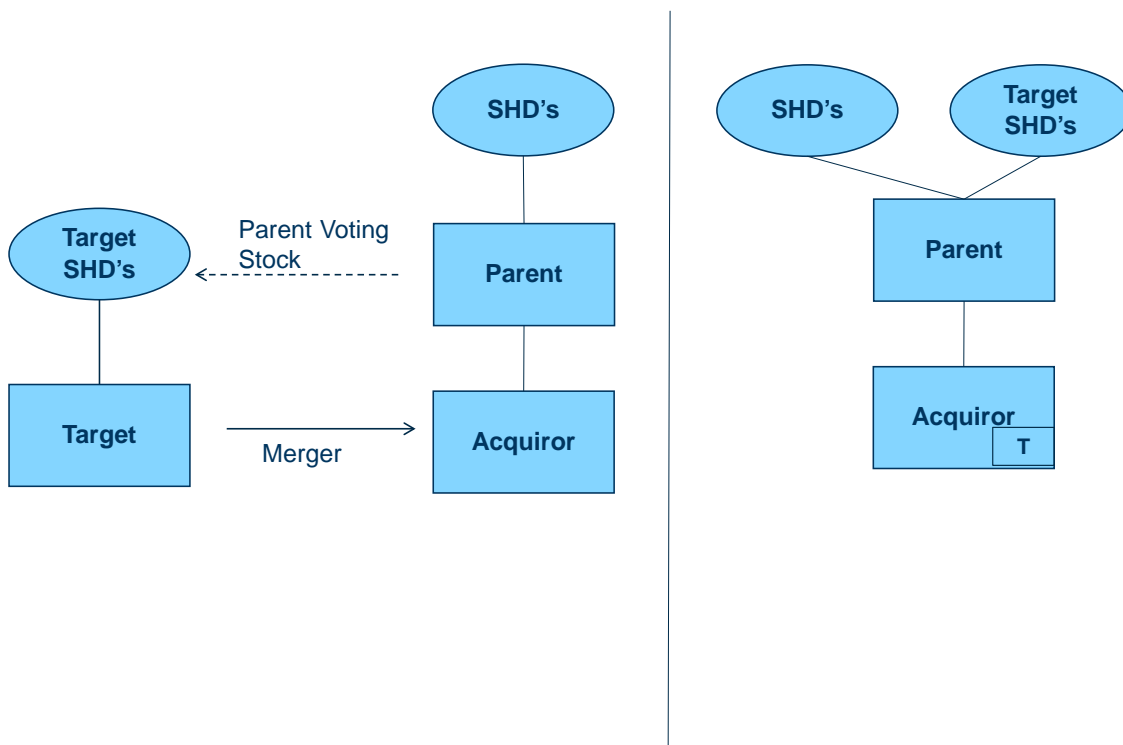

87

## Asset Reorganizations: Forward Subsidiary Merger (cont'd)

### “Substantially All” Requirement

- Same requirements as for “C” and “D” reorganizations.

### Boot Allowed

- Up to 60% boot permitted.
- Stock of corporation in control of the Acquiror is transferred in reorganization.
  - Control measured under Section 368(c):
    - a. Controlling corporation must own directly 80% of the total combined voting power of all classes of stock entitled to vote; and
    - b. 80% of the total number of all other classes of stock of Acquiror.
- No Acquiror stock permitted.

88

## Asset Reorganizations: Type C

---

### Direct “C” Reorganization

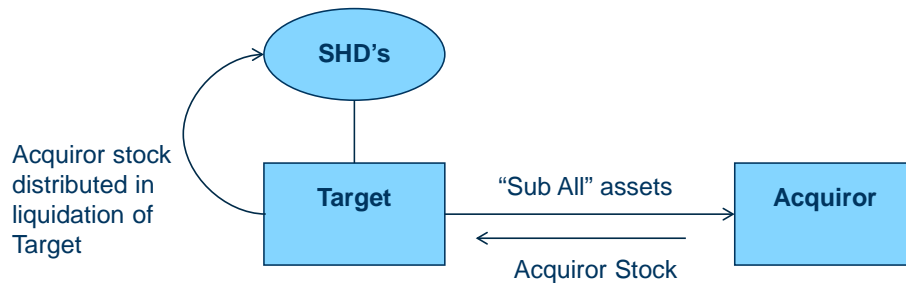

89

## Asset Reorganizations: Type C (cont'd)

---

### “Substantially All” Requirement

- Target must transfer substantially all its assets to acquirer pursuant to the reorganization.
- IRS advance ruling guidelines (Rev. Proc. 77-37) provide the “substantially all” requirement is satisfied if the acquirer acquires:
  - At least 90% of the fair market value (FMV) of the target’s net assets; and
  - At least 70% of the FMV of the target’s gross assets.
- Test generally focuses on trade or business assets (See Atlas Tool Co., Inc.).
- Target’s sale of business assets to an unrelated party prior to the reorganization doesn’t violate “sub all” (Substituted Asset Test) (See Rev. Rul. 88-48).
- Redemptions and distributions by target prior to the reorganization and that are part of the plan of reorganization are included in “sub all” testing.

90

## Asset Reorganizations: Type C (cont'd)

---

### Voting Stock Requirement

- Acquiror must acquire substantially all of Target's assets solely in exchange for voting stock of Acquiror or Acquiror's parent, but not both (i.e., direct or triangular).
- Possible to have up to 20% boot (Section 368(a)(2)(B) – Boot Relaxation Rule).
- Liabilities assumed by Acquiror treated as boot for purposes of applying Boot Relaxation Rule.
- Practical result - no boot permitted.
- Acquiror's pre-existing ownership of Target stock doesn't prevent "solely for voting stock" requirement to be satisfied.
  - Bausch & Lomb doctrine abandoned in 2000.
  - Pre-2000 Acquiror's ownership of old and cold Target stock could preclude reorganization treatment.

### Other Considerations

- Requires actual transfer of assets and assignment of contracts.
- Transfer taxes may apply.

91

## Asset Reorganizations: Type C (cont'd)

---

### Liquidation Requirement

- Target must liquidate pursuant to the plan of reorganization.
- Liquidation can occur in various forms:
  - Upstream merger of T into P.
  - LLC conversion of T or check-the-box election for T.

92

## Asset Reorganizations: Type C (cont'd)

### “C” Reorg Through LLC Conversion – Base Case

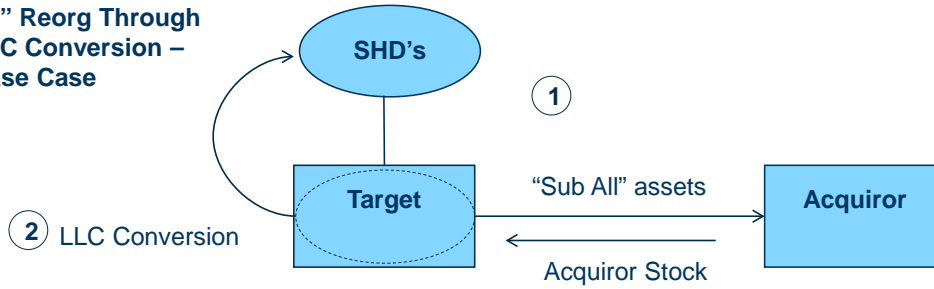

### Overlapping “A” and “C” Reorgs

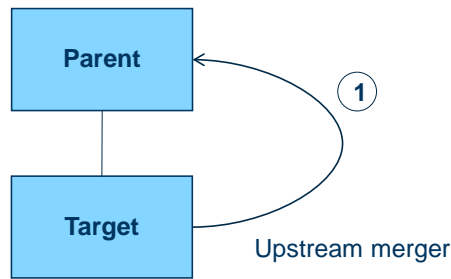

93

## Asset Reorganizations: Triangular C

### Triangular “C” Reorganization

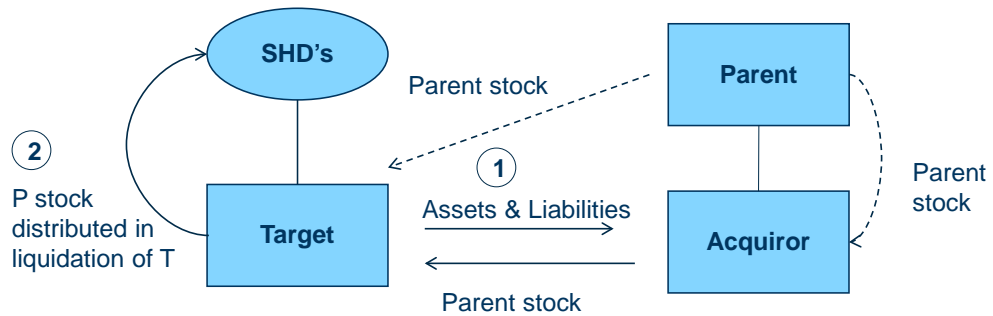

**Note:** P can transfer its stock directly to T on behalf of Acquiror or transfer it to Acquiror which then transfers it to T.

94

## Stock Reorganizations: Type B

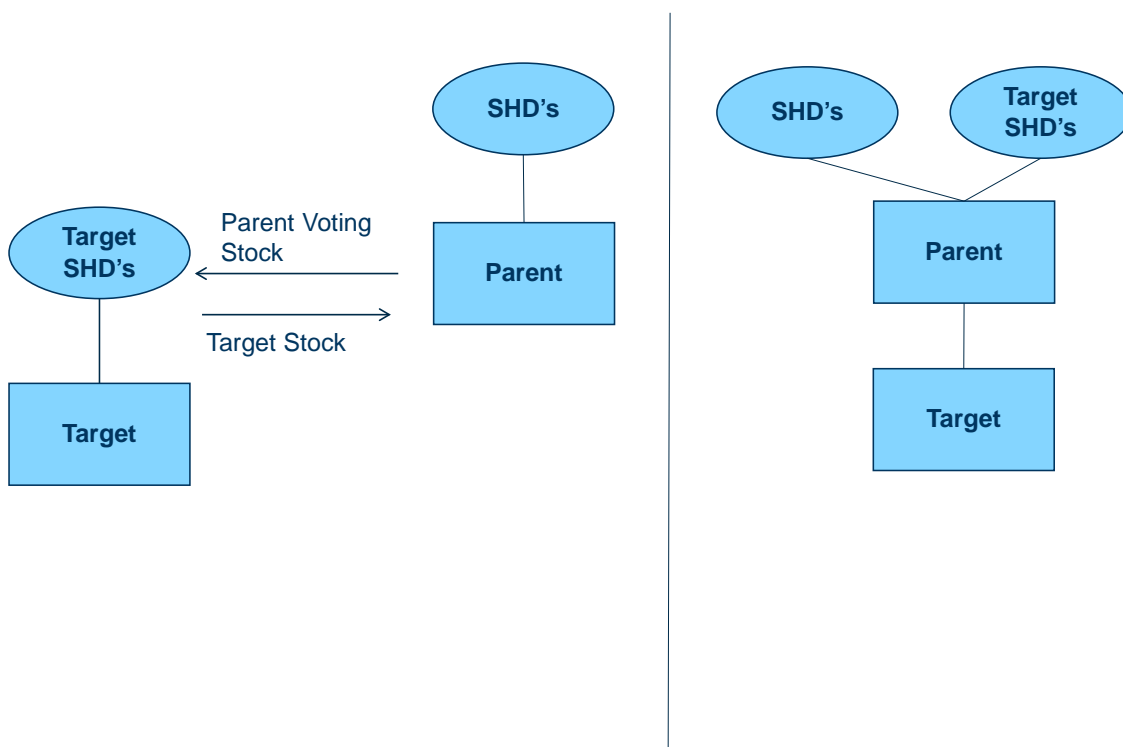

95

## Stock Reorganizations: Type B (cont'd)

### Solely for Voting Stock Requirement

- Stock of Acquiror (Direct “B”) or its parent (Triangular “B”) not both.
- Cash paid by Acquiror to Target shareholders in lieu of issuing fractional shares is permitted.
- Cash paid to dissenters permitted if paid by Target only.

### 80% Control Requirement

- Acquiror must have Section 368(c) control of Target immediately after the exchange:
  - 80% of the total voting power of all classes of stock entitled to vote and
  - 80% of the number of shares of all other classes of stock.
- Step transaction applies to test control.

### Creeping “B” Permitted if:

- The T stock already owned by Acquiror is either old and cold or acquired solely in exchange for P voting stock; and
- Acquiror acquires the remaining Target stock solely in exchange for its voting stock and ends up with 80% control of Target.

96



## Stock Reorganizations: Reverse Subsidiary Merger (cont'd)

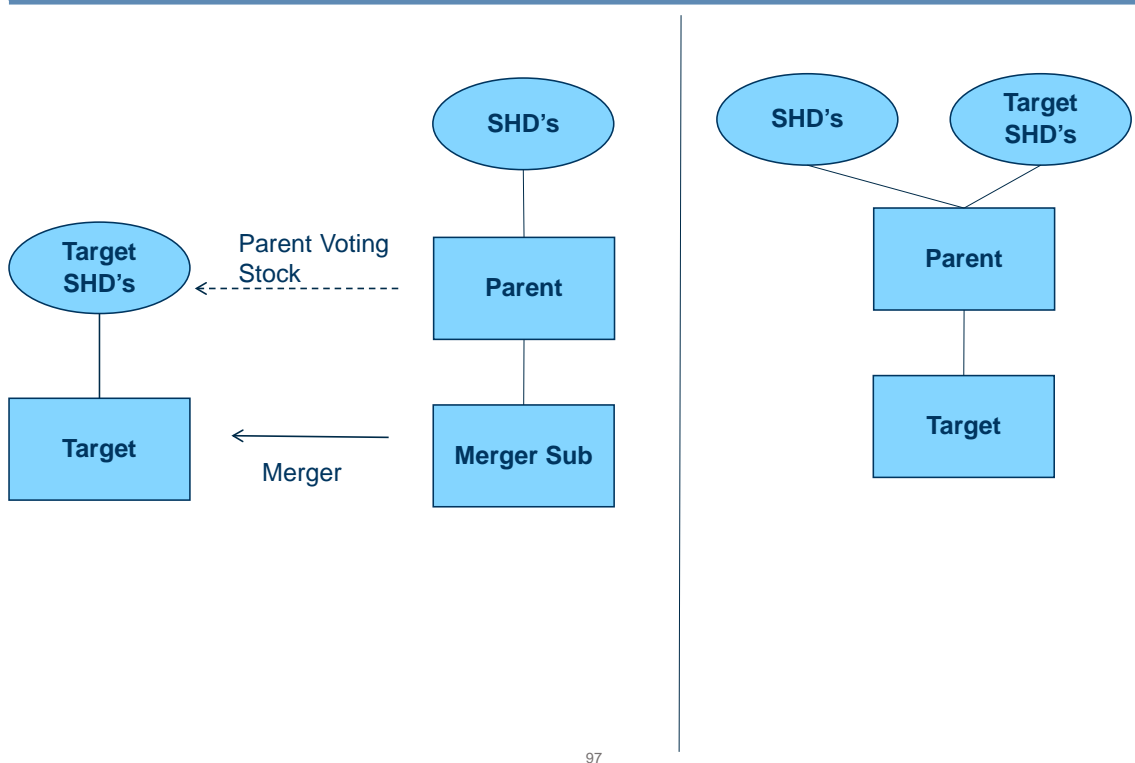

97

## Stock Reorganizations: Reverse Subsidiary Merger (cont'd)

### Merger Requirement

- Merger Sub must merge with an into Target with Target surviving.

### Solely for Parent Voting Stock Requirement

- Only voting stock of Parent permitted – no stock of Merger Sub allowed.
- Up to 20% boot permitted. If boot in excess of 20% is exchanged in the transaction the reverse merger will likely qualify as a qualified stock purchase under Section 338(d). (See Rev. Rul. 2001-46).

### 80% Control Requirement – Two Prongs

- Parent must have Section 368(c) control of Merger Sub before merger.
- Parent must acquire Section 368(c) control of Target in the merger.
  - 80% of the total voting power of all classes of stock entitled to vote and
  - 80% of the number of shares of all other classes of stock.

### Substantially All Requirement

- Target must hold substantially all of its assets and the assets of Merger Sub after the merger.

98

## Tax-Free Reorganizations: Basic Requirements

---

### Statutory Requirements

- Section 368 provides the definition for the term “reorganization”.
- Must look to other Code Sections for the tax effects to the various parties to the reorganization and exchanging shareholders.
  - Treatment to Acquirer – Sections 362, 1032 and 1223.
  - Treatment to Target – Section 361.
  - Treatment to Target Shareholders – Sections 354, 356, 358, 1223 and potentially 367.
- Impact on Target tax attributes and methods determined under Section 381, 382, 383, 384 and SRLY.

### Judicial and Regulatory Requirements

- Step Transaction Doctrine.
- COBE (not applicable to “E” or “F” reorganizations).
- COI (not applicable to “E” or “F” reorganizations).
- Business Purpose.
- Plan of Reorganization.

99

## Tax-Free Reorganizations: COBE

---

### General

- The issuing corporation must either continue the historic business operations of the target or use a significant portion of target’s historic business assets in a business. (Treas. Reg. §1.368-1(d)).
- Can be satisfied by qualified group members or partnerships.
- Not applicable to Type “E” and “F” reorganizations.

### Business Continuity

- Target’s historic business is generally the business it has conducted most recently.
- A historic business is not one Target enters into as part of a plan of reorganization.
- If Target has more than one line of business Acquiror must continue only one significant line of business, not all lines.

### Asset Continuity

- Business assets include stock/securities, tangible or intangible assets.
- Assets considered “significant” based upon relative importance to operation of business.
- Net fair market value of assets is considered but not dispositive.

## Tax-Free Reorganizations: COI

---

### General

- COI prevents transactions that more closely resemble sales from qualifying for non-recognition treatment.
- A substantial part of the value of the proprietary interests in the Target corporation be preserved in the reorganization.
- Target shareholders must receive stock in acquiring corporation (or its parent in the case of a triangular reorganization) to satisfy COI.
- Amount of Acquiring corporation stock required to satisfy COI differs by type of reorganization.
- Pre-reorg dispositions of Target stock to persons unrelated to Target or Acquiror is permissible.
- Post-reorg dispositions of Acquiring corporation stock to unrelated persons permissible.
- A creditor's claim against a Target corporation may be treated as a proprietary interest in Target (e.g., Chapter 11 proceedings) and thereby need to be preserved in the reorganization.

101

## Tax-Free Reorganizations: Business Purpose

---

### Business Purpose

- The transaction must be undertaken for reasons “germane to the continuance of the business of a corporation a party to the reorganization” Treas. Reg. §1.368-2(g) and Gregory v. Helvering, 293 U.S. 465 (1935).
- Shareholder level business purpose alone will not suffice.
- IRS generally looks to the motivations of both Acquiror and Target.
- Does a valid business purpose need to be the principal purpose for the reorganization?
  - The mere presence of tax planning motives will not cause the transaction to fail the business purpose test provided the business reasons for the reorganization are real and substantial.

### Plan of Reorganization

- Contemplates the bona fide execution of one of the transactions described in Section 368(a).
- Limits non-recognition of gain or loss to only those distributions or exchanges that are directly part of a reorganization described in Section 368(a).
- Typically evidenced by written document, agreement or board resolution.

102

## Tax-Free Reorganizations: Consequences to Parties

---

### Target

- No gain or loss recognized upon the transfer of property in exchange for stock or securities of another corporation. Section 361(a).
- No gain or loss recognized if target distributes any boot received in the reorganization to its shareholders in the reorganization. Section 361(b).
- Gain recognized if target distributes its appreciated property to shareholders pursuant to the reorganization. Section 361(c).

### Acquiror

- No gain or loss recognized upon issuance of its shares. Section 1032.
- Basis in property or stock acquired is equal to target's basis or exchanging shareholder's basis, increased by any gain recognized by target or the exchanging shareholder. Section 362(b).
- Holding period for assets/stock acquired is the same as target's and/or exchanging shareholder. Section 1223(2).

103

## Tax-Free Reorganizations: Consequences to Parties (cont'd)

---

### Exchanging Shareholder

- No gain or loss recognized of target shareholder exchanges stock or securities in target for stock or securities of acquiror. Section 354.
- If boot is received in the reorganization, then gain is recognized but not in excess of the amount of boot received (boot within gain rule). Section 356(a)(1).
- If all boot received (i.e., cash "D" reorganization) the gain recognized is characterized as a dividend (again subject to boot within gain limit). Section 356(a)(2).
- Basis of acquiror stock or securities received is the same as the basis of target stock or securities surrendered, increased by any gain/dividend recognized by target shareholders. Section 358(a)(1).
- Basis of all other property received (i.e., boot) is FMV. Section 358(a)(2).
- Holding period of stock/securities received is the same as the holding period for target stock/securities exchanged in the reorganization. Section 1223(1).

104

## Section 351 Exchanges

---

### Transfer of Property Requirement

- Property is broadly defined but excludes services and certain kinds of debt.

### Solely In Exchange for Stock Requirement

- No stock required where meaningless gesture.
- NQPS treated as boot.

### 80% Control Requirement

- Transferor must own 80% of the total voting power of all classes of stock entitled to vote and 80% of the number of shares of all other classes of stock immediately after the transfer.
- NQPS counted as stock for testing control.
- Step transaction applies to test control.

105

## Section 351 Exchanges: Consequences to Parties

---

### Transferor

- No gain or loss recognized by Transferor provided Section 351(a) requirements satisfied.
- Gain recognized to extent Section 351(a) satisfied but boot is received by Transferor.
- Transferor's basis in Transferee shares received is equal to the basis in the property transferred, increased by any gain recognized by the Transferor in the Section 351 exchange. Section 358.
- Transferor's holding period in the Transferee shares is the same as the holding period in the property transferred. Section 1223(1).

### Transferee

- No gain or loss recognized on issuance of shares. Section 1032.
- Basis in property received is the same as the basis held by Transferor, increased by the amount of any gain recognized by Transferor.
- Transferee's holding period includes the time Transferor held the property. Section 1223(2).

106