



Development of PLC-based Tension Control System

REN Sheng-le*, LU Hua, WANG Yong-zhang, FU Hong-ya

Department of Mechanical Engineering, Harbin Institute of Technology, Harbin 150001, China

Received 22 May 2006; accepted 22 November 2006

Abstract

Fiber winding tension is an important factor in the molding techniques of composite material which influences the quality of winding product directly, and the tension control is a key technique in fiber winding techniques. This paper introduces a closed-loop tension control system with the programmable logic controller (PLC) with function modules as its control kernel, the alternating current (AC) servo motor as execute element and the radius-following device to accomplish the real-time radius compensation. The mechanism of the tension control system is analyzed and the numerical model is set up. The compensation technique of the radius of the scroll is analyzed. Experimental results show that the system is well qualified with high control precision and high reaction speed.

Keywords: tension control; PLC; numerical control winding machine; AC digital servo motor

The components of composite material fiber winding possess such advantages as low weight, high strength, and high corrosion resistance, and they are widely applied in aviation and aerospace industry. Many researches have shown that improper or unstable tension leads to a strength loss of 20%-30% of the fiber wound components. An ideal tension control system should provide stable and adjustable tension during the winding process^[1-3].

With the development of the winding machine, tension controllers have, so far, undergone three stages of development, i.e., mechanical tension controller, electrical tension controller and computerized tension controller^[4-5]. With the development of electronic technology and the appearance of the microprocessor of higher cost performance, computerized tension controller came into use. Microprocessor becomes the kernel of the control system and thus cuts down the number of circuits of the electronic control system, which greatly simplifies

the system, improves its reliability and makes possible the application of advanced control methods. Therefore, this type of controllers is widely used^[6-7].

The tension control techniques are becoming mature and the specifications are being improved in some developed countries. However, the fiber winding industry of China started up late and still drops behind compared with the western countries.

Mechanical tensioners, with low precision and slow response, account for the main part of domestically-applied tensioners, and cannot meet the tension requirements. Therefore, this paper presents a PLC-based tension control system.

1 Set-up of the System Scheme

1.1 Construction of the system

A winding tension control system generally consists of three main parts, namely the unwinder, the processor and the winder, and it may also include the measuring and control parts, ancillary transport apparatus, and a load cell. The type of the winder and that of the unwinder may be one of the

*Corresponding author. Tel.: +86-451-86413812.

E-mail address: renshengle@hit.edu.cn

Foundation item: National Natural Science Foundation of China (50175020)

two drive types, surface drive or center drive. The surface drive means that a scroll or belt is set on the surface of the winding material and the drive force is generated through friction. The center drive is to set a drive mechanism on the center shaft of the scroll, where the linear speed and the tension force of the winding fiber vary with the radius of the scroll, leading to the so-called “scroll thick”^[8]. The phenomenon of “scroll thick” makes the tension control very complex, but the center drive mode is widely applied due to its wide applicability.

1.2 Design of tension control scheme

This system adopts a scheme with a center drive and outward-draw fiber configuration. Since the output torque of the AC digital servo motor is in direct proportion to the fiber tension force and the scroll radius, the output torque should decrease as the scroll radius decreases to acquire a constant fiber tension. The change of the scroll radius can be measured by a radius following device and the sampled radius change then passes through an analog-digital converter and is sent to the PLC. By reading the desired value of the tension force, the radius and tension force are calculated with the preset calculating algorithm. The speed instruction and torque limit instruction are issued and digital-to-analog converted to output the analog voltage signal to control the servo driver. The servo driver controls the rotating speed and output torque to control the fiber tension. The servo motor’s speed and torque are measured by the pulse encoder and the Hall element and fed back to the PLC system to compose a closed loop system. The mechanism of the system is shown in Fig.1.

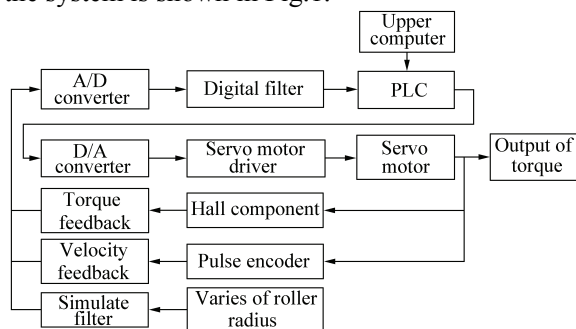

Fig.1 Principle of tension control system.

The main components in the system include

(1) A Panasonic programmable controller (FP0-C10RS), a 12-bit FP0-A80 and an FP0-A04V ancilliary conversion module.

(2) A Panasonic AC digital servo driver and servo motor.

(3) A radius-following device including a radius following arm and a rotary potentiometer.

2 Mathematical Model

Effective control of the fiber tension is required in fiber winding. Due to the versatility of the core mold shape and winding shape, the linear speed of the fiber is difficult to be kept constant and the variation principle is extremely complex. Therefore, the influence of the speed on the tension force should be taken into consideration in the mechanical analysis of the controlled object. The PLC with function modules as the control system’s control kernel, and the needed tension can be enacted from man-machine interface through the serial communication between PLC and upper computer. The input of the radius value, the torque feedback and the velocity feedback, the running of the preset calculating algorithm and the output of the system are done by the PLC with function modules.

When the unwinder is considered, the dynamic torque equilibrium equation can be expressed as follows

$$M(t) = J(t)\dot{\omega}(t) + J(t)\omega(t) + TR(t) + M_f + M_0 \quad (1)$$

where T is the yarn tension, $R(t)$ is the real-time scroll radius, $M(t)$ is the resistant moment of the AC servo motor, M_f is the viscous frictional moment, $\omega(t)$ is the angular velocity of the scroll, $J(t)$ is the rotating inertia of the scroll and the yarn roll, and M_0 is the dry frictional moment.

As shown in Eq.(1), the scroll radius, the resistant moment, the angular velocity of the unwinder and the rotating inertia of the scroll are all functions of time, and the system is thus a complex multivariable time-varying system.

Proper simplification of the torque equilibrium equation is carried out with classical control theory

based on the following rules:

(1) The dry frictional moment and the viscous frictional moment are very little and may be ignored.

(2) The influence of $\dot{J}(t)\omega(t)$ on the tension force may be ignored since the instantaneous inertia changes very slightly.

(3) The scroll radius is real-time measured and fed back by the radius following device.

Eq.(1) is then simplified as

$$TR(t) = M(t) + J(t)\dot{\omega}(t) \quad (2)$$

Therefore, the variations of scroll diameter and scroll angular velocity are the main influencing factors of the yarn tension.

3 Compensation of the Radius of the Scroll

The radius change of the scroll causes the change of the scroll moment, i.e., the change of the $TR(t)$ in Eq.(2). One end of the radius following arm touches the scroll, and the other end is connected to the rotary potentiometer via gear magnifying structure, thus transforming a change in the spindle radius to a change of voltage, as shown in Fig.2.

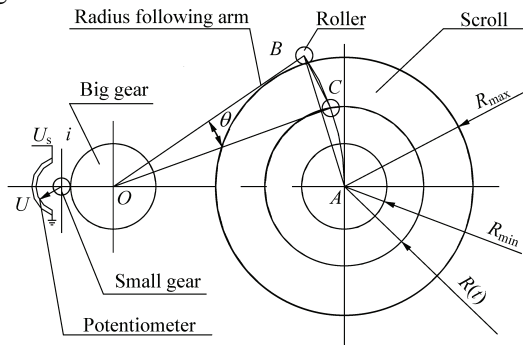

Fig.2 Radius following device.

Because $L \gg AB$, there are the followings

$$\begin{aligned} \tan \theta &= \frac{BC}{OB} \\ BC &\approx R_{\max} - R(t) \\ OB &= L \end{aligned}$$

Trimmed as

$$\tan \theta = \frac{R_{\max} - R(t)}{L}$$

or

$$\theta = \arctan \frac{R_{\max} - R(t)}{L}$$

where L is the length of radius following arm, R_{\max} is the maximum radius of scroll, and $R(t)$ is the instantaneous scroll radius.

Suppose the transmission ratio of the gear is i , then the angle of the small gear is given as

$$\phi = i\theta$$

For the potentiometer,

$$U = \frac{U_s}{\phi_s} \phi$$

where U is the output voltage of rotary potentiometer, U_s is the power supply voltage of rotary potentiometer, and ϕ_s is the total angle of rotary potentiometer.

Trimmed as

$$U = \frac{U_s i}{\phi_s} \arctan \left| \frac{R_{\max} - R(t)}{L} \right| \quad (3)$$

4 Software Development of the System

The software development makes full use of the capabilities of FP0-C10RS, the digital-analogy I/O modules, the hardware and software resources of the PC computer.

The precision of the analog-digital or digital-analog conversion depends on the number of bits of the analog-digital converter and digital-analog converter. FP0-A80 and FP0-A04V both are 12 bits, and the resolution is 1/4 000 when the output and input range $-10V$ - $+10V$, while the FP0 is 16 bits, so the control resolution of the system can be assured. The operation speed of each basic instruction is $0.9 \mu s$ /step, thus 500 steps program needs only 0.5 ms, and the conversion speeds of FP0-A80 and the FP0-A40V both are 1 ms/channel, so the control speed of the system is assured. The PLC ladder diagram is applied to develop the whole control program. However, the input of the parameters is not intuitionistic, neither is the display of the real-time tension and the scroll radius. In order to solve this problem, a control program is developed for the host computer on the interface of which the operator can perform the input of the parameter and the display of the real-time tension, the speed and the scroll radius. The programming port of all the FP

PLC's support OPEN MEWTOCOL PROTOCOL. Upper computer sends a COMMAND to PLC as an ASCLL string. Then the PLC automatically returns the RESPONSE based on the COMMAND.

COMMAND format

%	Station number	#	Command	Text data	Check code	Terminater
---	----------------	---	---------	-----------	------------	------------

RESPONSE format

%	Station number	\$	Command	Text data	Check code	Terminater
---	----------------	----	---------	-----------	------------	------------

RESPONSE format on Error

%	Station number	!	Error	Check code	Terminater
---	----------------	---	-------	------------	------------

%; This is a fixed character. All the previous uncompleted text strings are ignored when PLC receives “%” which means the beginning of the next command.

#, \$, !: Indicate what the string is: COMMAND(#), RESPONSE(\$) or ERROR RESPONSE(!).

The inputs of the system are the voltage feedback by radius following device, the torque feedback of alternating numeric servo-electromotor and the velocity feedback. The output of the system are alternating numeric servo-electromotor torque and velocity voltage. The software control flow of the tension control system is shown in Fig.3.

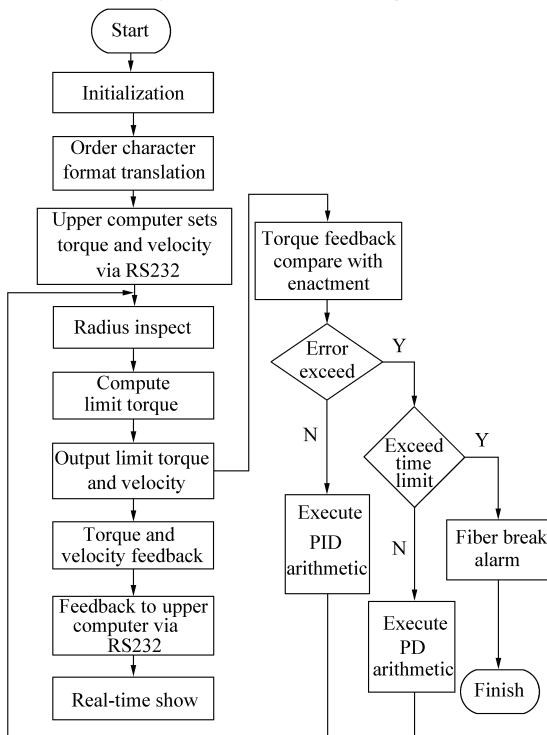

Fig.3 Flow of control program of the system software.

5 Simulation and Experimental Results

Experimental research of the tension control in real winding states was carried out through simulating the real working circumstances to test the feasibility and control precision. When the tension was set to 10 N, the constant-tension curve under simulation and experimental conditions can be acquired with a near constant tension, as shown in Fig.4 and Fig.5, respectively. In order to know the work state of the AC servo motor when the tension changes, the tension force was changed from 5 N to 10 N and the variation curves of which are shown in Fig.6 and Fig.7 under simulation and experimental conditions, where the overshooting and fluctuation are rather small and the response time is less than 0.3 s.

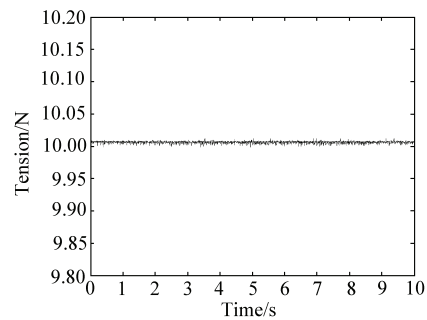

Fig.4 Simulation tension variation with time (tension = 10 N).

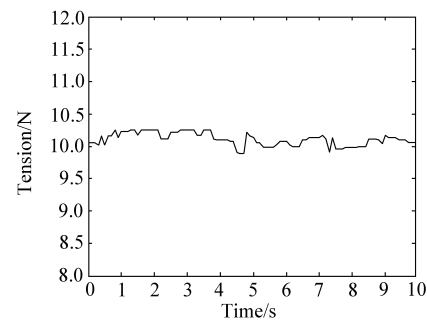

Fig.5 Experiment tension variation with time (tension = 10 N).

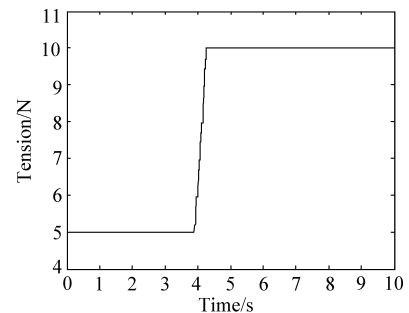

Fig.6 Simulation tension variation with time (tension changes from 5 N to 10 N).

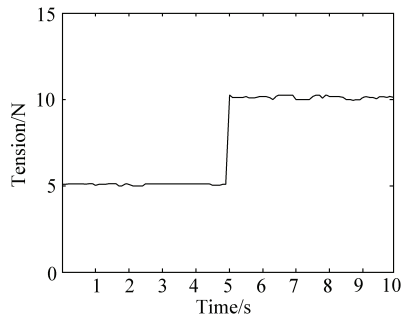

Fig.7 Experiment tension variation with time (tension changes from 5 N to 10 N).

5.1 Analysis of static difference rate

Static difference rate is a very important index for evaluating the performance of the system. It can be expressed as follows

$$\delta = \frac{\Delta T}{T_m} \times 100\% \quad (4)$$

where $\Delta T = T_{\max} - T_{\min}$, T_{\max} is the maximum tension, T_{\min} is the minimum tension, and T_m is the average tension.

The analysis of static difference rate of tension is shown in Table 1.

Table 1 The analysis of static difference rate of tension

Status	Enactment tension/N	T_{\max}/N	T_{\min}/N	$\Delta T/N$	T_m/N	$\delta/\%$
Constant tension	10	10.253	9.894	0.359	10.109	3.55
Variational tension	5	5.126	4.964	0.162	5.077	3.19
	10	10.261	9.952	0.309	10.111	3.06

From the analysis above, the static difference of the system is less than 4%, which meets the required performance index.

5.2 Analysis of fluctuation rate

Whether the tension fluctuating rate meets the requirements is a key index for evaluating the performance of the designed tension control system. Enacted a initialized yarn tension, after compensation calculation, output it. Then, test the actual tension and find out the maximum and minimum tensions. The equation for computing the tension fluctuation rate δ' is as follows

$$\delta' = \left| \frac{T_{\max} - T_{\min}}{T_{\text{anticipated}}} \right| \times 100\% \quad (5)$$

The analysis of fluctuation rate of tension is shown in Table 2.

Table 2 The analysis of fluctuation rate of tension

Status	Enactment tension/N	T_{\max}/N	T_{\min}/N	$\Delta T/N$	$\delta'/\%$
Constant tension	10	10.253	9.894	0.359	3.59
Variational tension	5	5.126	4.964	0.162	3.24
	10	10.261	9.952	0.309	3.09

6 Conclusions

Simulation and experimental results show that the system is feasible with the PLC as the kernel, the AC digital servo motor as the execute element and a radius following device to perform the radius compensation. The characteristics of the system include

(1) A Panasonic FP-series PLC and functional modules serve as the control kernels. The small volume, high integrity, high reliability, excellent control capability and the low cost all make the system convenient and compact with high enough reliability and precision.

(2) The yarn-retaking device can be left out, because the servo motor can perform the same function.

(3) The modularized software design facilitates the construction expansion and the secondary development of the customers.

(4) The friendly programming environment of the Panasonic FPWIN_GR software encapsulates the capability of on-line programming. Parameters can be changed on line and the control effects can be seen instantaneously.

References

- [1] Leng X W. Fibre winding theory. Shandong: Publishing House of Shandong Science and Technology, 1990. [in Chinese]
- [2] Wang Q S. The foundation and experimentation research of precision tension control system based on PLC. PhD thesis, Harbin: Harbin Institute of Technology, 2005. [in Chinese]
- [3] Wang C X, Wang Y Z, Lu H. A tension control system using magnetic particle clutch as the actuator. Mechanism & Electron 1999; (3): 5-7. [in Chinese]

- [4] Lossie M, Brussel H V. Design principles in filament winding. *Composites Manufacturing* 1994; 5(1): 5-13.
- [5] Miller G A. Control of tension in textile filament winding. *Mechanics* 1995; 5(2): 117-131.
- [6] Dudzinski M. Understanding center-driven web winders-part 1. *Power Transmission Design* 1995; 37(4): 27-31.
- [7] Gerd V, Kurt H. Importance and methods of tension control. *Processing of the Electrical Electronics Insulation Conference 1997 IEEE*. NJ, USA: Piscata way, 1997; 517-524.
- [8] Johnmayers. Taking the mystery out of winder controls. *Power Transmission Design* 1988; 30(4): 27-34.

Biographies:



REN Sheng-le Born in 1979. He received Bachelor's degree from Harbin Engineer University (HEU) in 2000 and Master's degree from Harbin Institute of Technology (HIT) in 2002. He is a Ph.D. candidate of HIT in 2002. Now, his re-

search interests include numerical control winding machine and tension control system.

E-mail: renshengle@hit.edu.cn

LU Hua Born in 1954. He is a senior engineer and master tutor of HIT. He has completed more than 18 scientific research items and has published more than 20 academic papers in recent years. Now, his research interests include computer control NC technology.

E-mail: nc-mach@hit.edu.cn

WANG Yong-zhang Born in 1941. He is a professor and doctoral tutor of HIT. He has completed 22 scientific research items and 5 monographs and has published more than 70 academic papers in recent years. Now, his research interests include NC technology, application of computer in machining and design/machining/controlling of modern manufacturing systems.

E-mail: nc-mach@hit.edu.cn

FU Hong-ya Born in 1963. He is a professor and doctoral tutor of HIT. He has completed more than 10 scientific research items and has published more than 30 academic papers in recent years. Now, his research interests include NC technology and theory research and application of CAD/CAM.

E-mail: nc-mach@hit.edu.cn