



3501i
4501i
5501i

OPERATION GUIDE



Preface

Thank you for purchasing the 3501i/4501i/5501i.

This Operation Guide is intended to help you operate the machine correctly, perform routine maintenance, and take simple troubleshooting measures as needed so that the machine can always be used in the optimum condition.

Please read this Operation Guide before using the machine.

We recommend the use of our own brand supplies.

Please use our genuine toner containers, which have passed rigorous quality control testing.

The use of non-genuine toner containers may cause failure.

We will not be liable for any damages caused by the use of third party supplies in this machine.

A label is affixed to our genuine supplies as shown below.

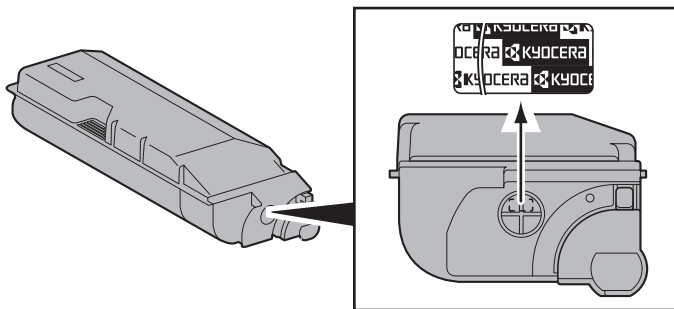

Overview

This machine is equipped standard with copy and print functions, and a scanned image can be sent to an E-mail recipient as an attachment or to a computer on the same network. A fax function is available as an option.

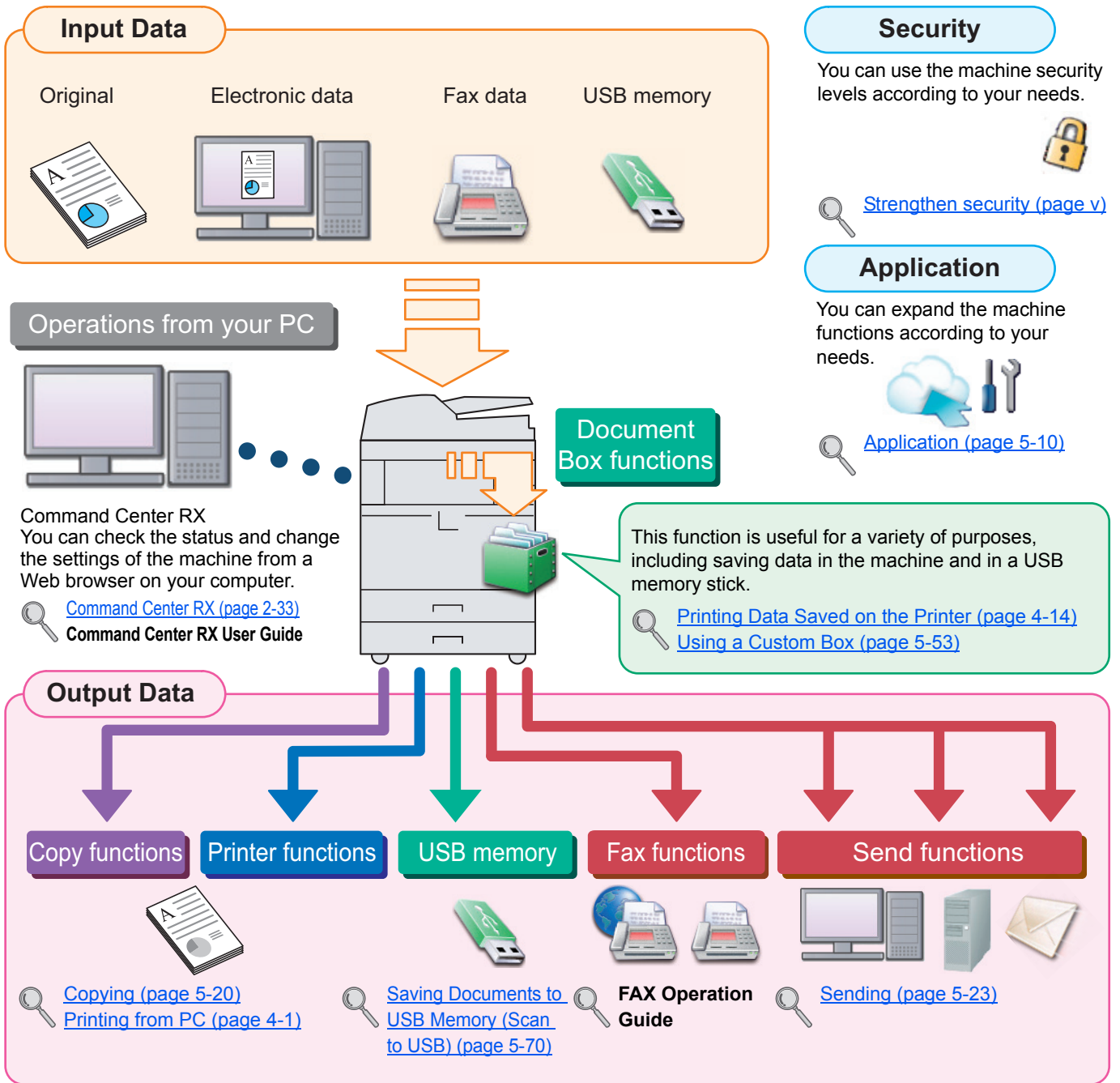











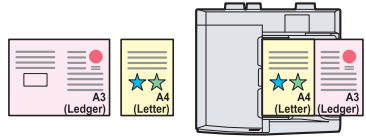

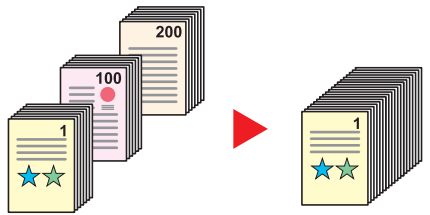
NOTE



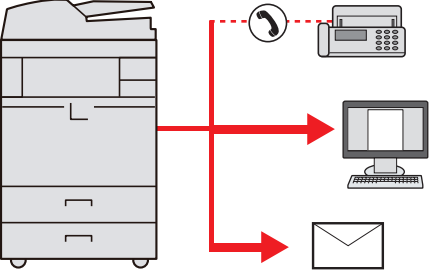

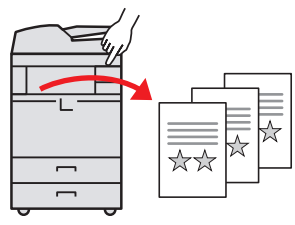

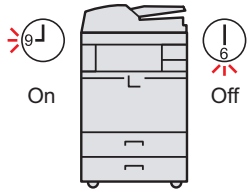
- Before using the machine, be sure to read [Legal and Safety Information on page 1-1](#).
- For preparations for use of the machine such as cable connections and software installation, refer to [Installing and Setting up the Machine on page 2-1](#).
- To learn how to load paper, place originals, set up shared folders, and add addresses to the address book, refer to [Preparation before Use on page 3-1](#).



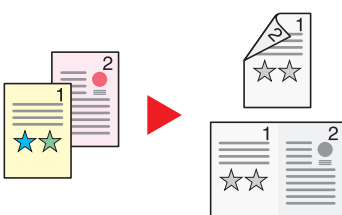



Machine Features



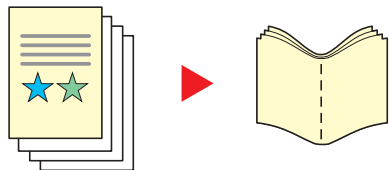

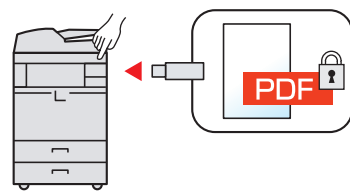

The machine is equipped with many useful functions. Here are some examples. For details, refer to [Using Various Functions \(page 6-1\)](#).



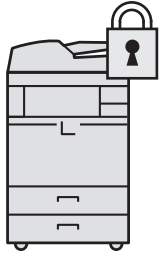

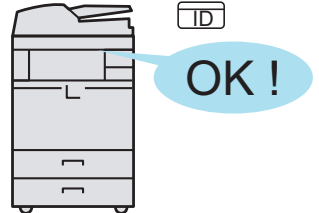

Optimize your office workflow		
<p>Access to frequently used functions with just one touch (Program)</p>  <p>You can preset frequently used functions. Once you set the functions as a preset program, all you need to do is press the program number to call up the functions. Using this program brings the same results even if operated by another person.</p> <p> Program (page 5-6)</p>	<p>Scan originals of different sizes at a time (Mixed Size Originals)</p>  <p>It is useful when preparing conference materials.</p> <p>You can set the different sized originals at one time so you don't need to reset the originals regardless of size.</p> <p> Mixed Size Originals (page 6-13)</p>	<p>Scan a large number of originals in separate batches and produce as one job (Continuous Scan)</p>  <p>It is useful when preparing many-page handouts.</p> <p>When a large number of originals cannot be placed in the document processor at one time, the originals can be scanned in separate batches and then copied or sent as one job.</p> <p> Continuous Scan (page 6-51)</p>

Optimize your office workflow	Save energy and cost	
<p>Send one time with multiple sending options (Multi Sending)</p>  <p>You can send a same document to the multiple destinations using a different method.</p> <p>You can specify multiple destinations of different send methods such as E-mail, SMB, and Fax.</p> <p>You can reduce your workflow by sending a job at once.</p> <p> Sending to Different Types of Destinations (Multi Sending) (page 5-36)</p>	<p>Save frequently used documents in the machine (Custom Box)</p>  <p>You can share frequently used documents with the others.</p> <p>You can save the frequently used document in the machine and print or send it when needed.</p> <p>A document can be shared among multiple users.</p> <p> Using a Custom Box (page 5-53)</p>	<p>Save energy as needed (Energy Saver function / Energy Saver Recovery Level)</p>  <p>The machine is equipped with Energy Saver function that automatically switched into Low Power Mode or Sleep Mode. You can set appropriate Energy Saver Recovery Level depending on the operation.</p> <p>In addition, the machine can automatically be switched into Sleep and recovered at a specified time for each day of the week.</p> <p> Energy Saver function (page 3-14) Weekly Timer Settings (page 8-56)</p>

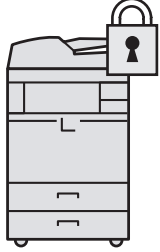
Save energy and cost		Create attractive documents
<p>Print multiple originals onto one sheet (Duplex / Combine)</p>  <p>You can print originals on both sides of the paper. You can also print multiple originals onto one sheet.</p> <p> Combine (page 6-30) Duplex (page 6-38)</p>	<p>Skip blank pages when printing (Skip Blank Page)</p>  <p>When there are blank pages in a scanned document, this function skips the blank pages and prints only pages that are not blank.</p> <p> Skip Blank Page (page 6-55)</p>	<p>Prevent image bleed-through (Prevent Bleed-through)</p>  <p>You can prevent image bleed-through from the reverse side when scanning thin originals.</p> <p> Prevent Bleed-thru (page 6-25)</p>

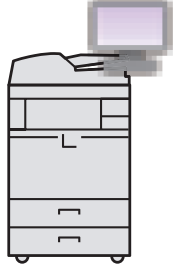
Create attractive documents	Strengthen security	
<p>Create a booklet (Booklet)</p>  <p>It is useful when preparing handout. You can create a magazine, pamphlet, or other booklet from sheet originals. Facing-page, two-sided copies of originals can be folded down the center to create a booklet. The cover page can be printed onto colored paper or heavy paper.</p> <p> Booklet (page 6-35)</p>	<p>Print a stamp on copies (Text Stamp / Bates Stamp)</p>  <p>It is useful when adding text or date that is not included in originals. You can print desired text and date as a stamp onto the first page or all pages.</p> <p> Text Stamp (page 6-47) Bates Stamp (page 6-49)</p>	<p>Password-protect a PDF file (PDF Encryption Functions)</p>  <p>Use the PDF format's password security options to restrict document viewing, printing and editing.</p> <p> Encrypted PDF Password (page 6-64)</p>

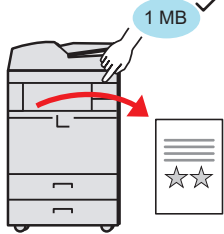
Strengthen security		
<p>Protect data on the hard disk (Encryption / Overwrite)</p>  <p>You can overwrite the unnecessary data that remains on the hard disk automatically.</p> <p>To prevent an external leakage, the machine is able to encrypt data before writing it to the hard disk.</p> <p> Data Security (page 8-50)</p>	<p>Prevent loss of finished documents (Private Print)</p>  <p>You can temporarily save a printer document in the machine. By printing the document from the machine prevents someone takes your document.</p> <p> Private Print/Stored Job (page 4-14)</p>	<p>Log in by ID card (Card Authentication)</p>  <p>You can log in simply by touching an ID card. You don't need to enter your user name and password.</p> <p> Card Authentication Kit(B) "Card Authentication Kit" (page 11-6)</p>

Strengthen security	Use functions more efficiently	
<p>Strengthen security (for administrator use)</p>  <p>Various functions are available for administrators to strengthen security.</p> <p> To Strengthen the Security (page 2-31)</p>	<p>Expand functions as necessary (Application)</p>  <p>The functionality of the machine can be expanded by installing applications.</p> <p>Applications that help you perform your daily more efficiently such as a scan feature and an authentication feature are available.</p> <p> Application (page 5-10)</p>	<p>Display file size before sending / storing a job (File Size Confirmation)</p>  <p>You can check the file size before sending/storing the document.</p> <p>If your server specifies an e-mail size limit, you can check the size in advance.</p> <p> File Size Confirmation (page 6-63)</p>

Use functions more efficiently

Install the machine without concerning the network cables (Wireless Network)



In an environment where the wireless LAN is used, you can install the machine without concerning the network cables.

 [Wireless Network \(page 8-48\)](#)

Use USB memory (USB Memory)



It is useful when you need to print document outside your office or you cannot print document from your PC. You can print the document from the USB memory by plugging it directly into the machine.

Original scanned at the machine can be saved in the USB memory also.

 [Printing Documents Stored in Removable USB Memory \(page 5-68\)](#)
[Saving Documents to USB Memory \(Scan to USB\) \(page 5-70\)](#)

Specify image file format (Scan Format)

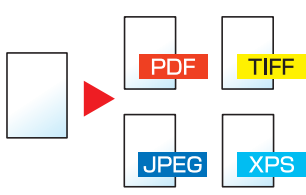

You can select the various file formats when sending/storing images.

 [File Format \(page 6-58\)](#)

Use functions more efficiently

Skip the error job (Job Skip Functions)

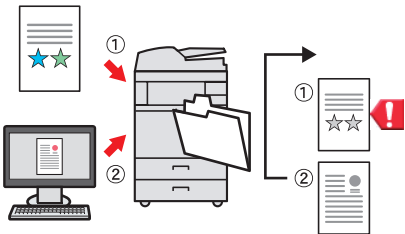

When paper empty error occurs at the cassette by specifying the special paper size or type, the machine skips the error job and performs the next job.

 [Error Job Skip \(page 8-55\)](#)

Perform remote operation (Command Center RX)



You can access to the machine remotely to print, send or download data. Administrators can configure the machine behavior or management settings.





 [Command Center RX \(page 2-33\)](#)

Color and Image Quality Functions

The machine is equipped with various color and image quality functions. You can adjust the scanned image as desired.











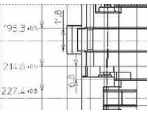
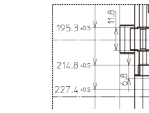

Basic Color Modes

The basic color modes are as follows. For details, refer to [Color Selection \(page 6-23\)](#).

Color mode	Description	Reference image	
		Before	After
Color/Gray Color/B & W	Automatically recognizes whether a document being scanned is color or black & white.		
Full Color	Scans a document in full color.		
Grayscale	Scans a document in grayscale.		
Black & White	Scans a document in black & white.		

Adjusting Image Quality

To adjust the image quality, use the following functions.

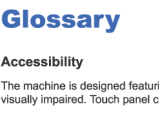
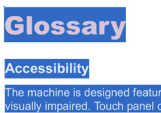
I want to...	Sample image		Function	Page
	Before	After		
Easily adjust the image quality to match your own image				
Remove dark background or bleed-through from the original such as a newspaper.			Program [Newspaper Copy]	page 5-6
Clearly reproduce fine lines, faint lines, broken lines, and other fine details in a CAD or other drawings.			Program [Drawing Copy]	page 5-6
Adjust the image quality precisely				
Adjust the density.			Density	page 6-21
Emphasize or blur the image outline. Example: Emphasize the image outlines			Sharpness	page 6-24
Darken or lighten the background (the area with no texts or images) of a document. Example: Lightening the background			Background Density	page 6-24
Prevent bleed-through in 2-sided originals.			Prevent Bleed-through	page 6-25
Adjust the scanned image				
Decrease the file size and produce the characters clearly.			File format [High Comp. PDF]	page 6-58
Convert a paper document to PDF with searchable text.			File format [PDF] or [High Comp. PDF] with [OCR]	page 6-58

Guides Provided with the Machine

The following guides are provided with the machine. Refer to each guide as needed. The contents of the guides are subject to change without notice for the purpose of improvement of machine performance.

Printed guides

Start using the machine quickly



Quick Guide

Explains how to use basic functions of the machine, how to use convenient features, how to perform routine maintenance, and what to do when problems occur.

For safe use of the machine



Safety Guide

Provides safety and cautionary information for installation and use of the machine. Be sure to read this guide before using the machine.

Safety Guide (3501i/4501i/5501i)

Indicates the space required for machine installation, and describes the cautionary labels and other safety information. Be sure to read this guide before using the machine.

Guides (PDF) on the DVD (Product Library)

Use the machine thoughtfully



Operation Guide (This Guide)

Explains how to load paper and perform copy, print and scan operations, and indicates default settings and other information.

Use the fax functions



FAX Operation Guide

Explains how to use the fax function.

Use the ID card



Card Authentication Kit (B) Operation Guide

Explains how to perform authentication using the ID card.

Strengthen security



Data Security Kit (E) Operation Guide

Explains how to introduce and use the Data Security kit (E), and how to initialize the system.

Easily register machine information and configure settings



Command Center RX User Guide

Explains how to access the machine from a Web browser on your computer to check and change settings.

Print data from a computer



Printer Driver User Guide

Explains how to install the printer driver and use the printer function.

Directly print a PDF file



KYOCERA Net Direct Print Operation Guide

Explains how to print PDF files without launching Adobe Acrobat or Reader.

Monitor the machine and printers on the network



KYOCERA Net Viewer User Guide

Explains how to monitor your network printing system (the machine) with KYOCERA Net Viewer.

Scan images and save with information



File Management Utility User Guide

Explains how to use File Management Utility to set various parameters and send and save scanned documents.

Print without using the printer driver



PRESCRIBE Commands Technical Reference

Describes the native printer language (PRESCRIBE commands).

PRESCRIBE Commands Command Reference

Describes the PRESCRIBE command functions and control for each type of emulation.

Install the Adobe Reader (version 8.0 or later) to view the manuals on the DVD.

About the Operation Guide (this Guide)

Structure of the guide

The Operation Guide contains the following chapters.

Chapter		Contents
1	Legal and Safety Information	Provides precautions regarding use of the machine and trademark information.
2	Installing and Setting up the Machine	Explains part names, cable connections, installation of the software, login, logout, and other matters related to administration of the machine.
3	Preparation before Use	Explains preparations and settings that are required in order to use the machine, such as how to use the operation panel, load paper, and create an address book.
4	Printing from PC	Explains functions that are available when the machine is used as a printer.
5	Operation on the Machine	Explains the basic procedures for using the machine, such as placing originals, making copies, sending documents, and using document boxes.
6	Using Various Functions	Explains convenient functions that are available on the machine.
7	Status/Job Cancel	Explains how to check the status of a job and the job history, and how to cancel jobs being printed or waiting to print. Also explains how to check paper and toner levels, how to check the device status, and how to cancel fax transmission.
8	Setup and Registration (System Menu)	Explains System Menu and how it relates to the operation of the machine.
9	User Authentication and Accounting (User Login, Job Accounting)	Explains user login and job accounting.
10	Troubleshooting	Explains what to do when toner runs out, an error is displayed, or a paper jam or other problem occurs.
11	Appendix	Describes convenient options that are available for the machine. Provides information on media types and paper sizes, and gives a glossary of terms. Explains how to enter characters, and lists the specifications of the machine.

Conventions Used in This Guide

Adobe Reader X is used as an example in the explanations below.

Click an item in the Table of Contents to jump to the corresponding page.

Click to move from the current page to the previously displayed page. This is convenient when you want to return to the page from which you jumped to the current page.

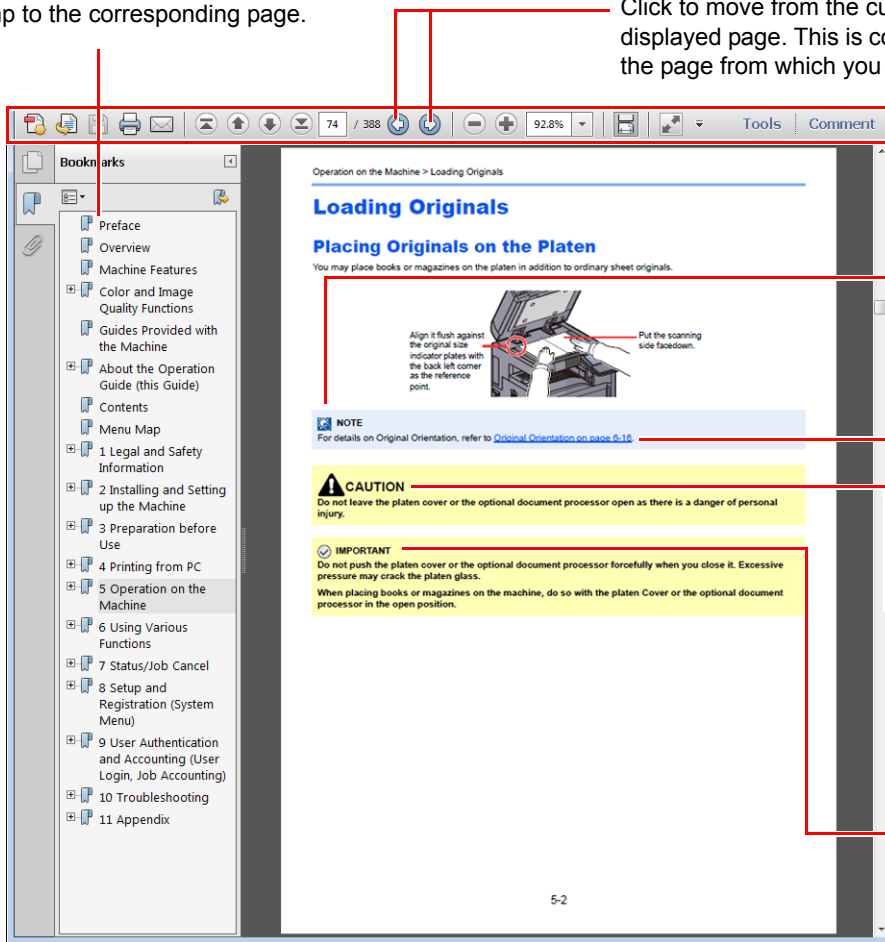

NOTE

Indicates supplemental explanations and reference information for operations.

Refer to

Click the underlined text to jump to the corresponding page.

CAUTION

Indicates that personal injury or mechanical damage may result from insufficient attention to or incorrect compliance with the related points.

IMPORTANT

Indicates operational requirements and restrictions to operate the machine correctly, and avoid damage to the machine or property.

NOTE

The items that appear in Adobe Reader vary depending on how it is used. If the Table of Contents or tools do not appear, refer to Adobe Reader Help.

Certain items are indicated in this guide by the conventions described below.

Convention	Description	Example
[Bold]	Indicates keys on the operation panel and buttons on your computer screen.	Press the [Start] key. Click the [OK] button.
[Regular]	Indicates keys on the touch panel.	Press [OK].
"Regular"	Indicates a message or setting displayed on the touch panel or computer screen.	"Ready to copy." appears. You can select from the "Print size" menu.

On pages that explain a convenient function, the modes in which that function can be used are indicated by icons.







Using Various Functions > Functions

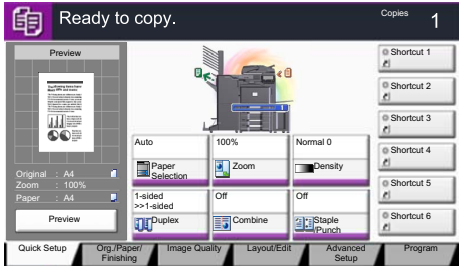

Functions

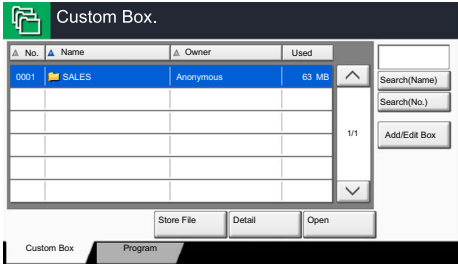
Original Size

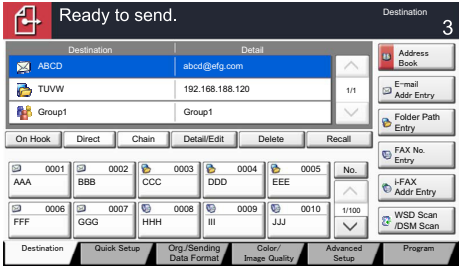

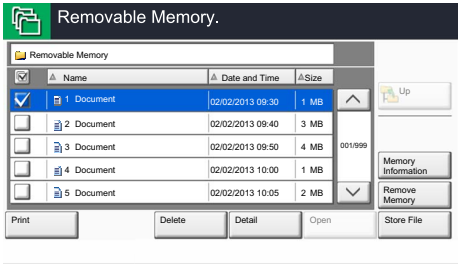
Specify the original size to be scanned.

Icon	Description	Icon	Description
	<p>The function can be used when copying a document.</p>  <p>Copy screen</p>		<p>The function can be used when saving to or printing from a custom box.</p>  <p>Custom box screen</p>
	<p>The function can be used when sending a document.</p>  <p>Send screen</p>		<p>The function can be used when saving to or printing from removable memory such as a USB memory stick.</p>  <p>Removable memory screen</p>

Icon	Description
 	<p>Access to the function is indicated by icons. Example: Press the [Org./Paper/Finishing] tab in the Copy screen to use the function.</p>

Conventions used in procedures for operating the machine

In this Operation Guide, continuous operation of the keys on the touch panel is as follows:

Actual procedure	Procedure indicated in this guide
Press the [System Menu] key ▼ Press [Common Settings] ▼ Press [∨] twice ▼ Press [Next] in "Message Board Settings"	Press the [System Menu] key, [Common Settings], [∨] (twice), and then [Next] in "Message Board Settings".

Touch panel keys that are pressed are outlined in red.

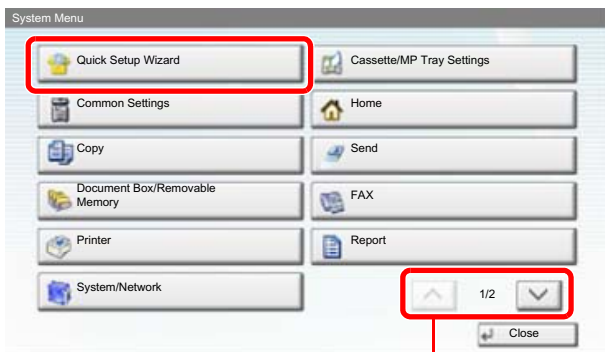





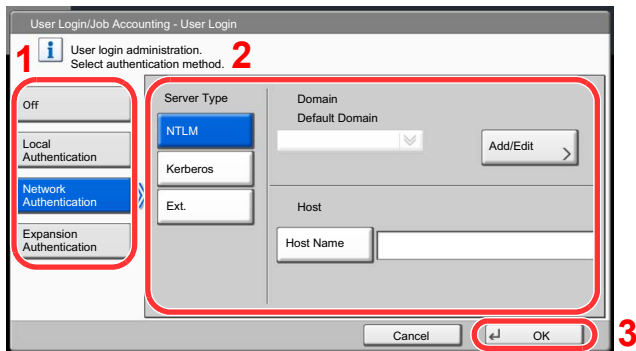

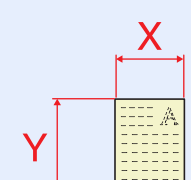
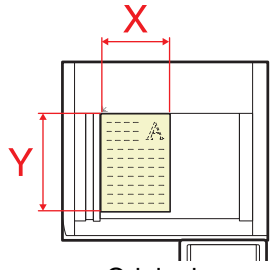

Press [∧] or [∨] to scroll up and down.

Procedures consisting of a sequence of operation panel or touch panel operations are numbered as shown below.

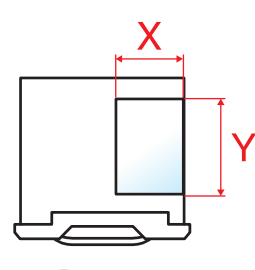

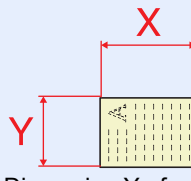
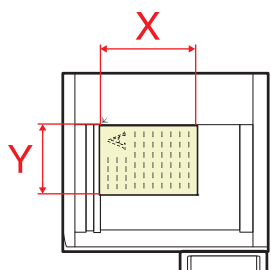
Originals and Paper Sizes

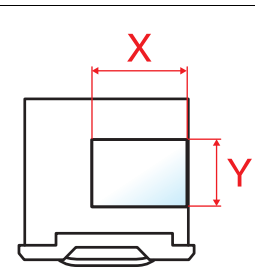
Original sizes and paper sizes such as A4, B5, and Letter can be used in both the horizontal and vertical orientations. To distinguish the orientations when these sizes are used, "R" is added to sizes used in the horizontal orientation. In addition, the following icons are used to indicate original and paper placement orientations on the touch panel.

Orientation	Original/Paper	Icons on the touch panel	Indicated size*
Vertical orientation  Dimension Y of the original/paper is longer than X.	 Original	 Original	A4, B5, A5, B6, A6 Letter, Statement
	 Paper	 Paper	
Horizontal orientation (-R)  Dimension Y of the original/paper is shorter than X.	 Original	 Original	A4-R, B5-R, A5-R, B6-R, A6-R, Letter-R, Statement-R
	 Paper	 Paper	

* Original/paper sizes that can be used vary depending on the function and source tray. For details, refer to [Specifications on page 11-22](#).

Contents

Preface	i
Overview	ii
Machine Features	iii
Color and Image Quality Functions	vii
Basic Color Modes	vii
Adjusting Image Quality	viii
Guides Provided with the Machine	ix
About the Operation Guide (this Guide)	x
Structure of the guide	x
Conventions Used in This Guide	xi
Contents	xv
Menu Map	xxii

1 Legal and Safety Information 1-1

Notice	1-2
Safety Conventions in This Guide	1-2
Environment	1-3
Precautions for Use	1-4
Laser Safety (Europe)	1-5
SAFETY OF LASER BEAM (USA)	1-6
Safety Instructions Regarding the Disconnection of Power	1-7
WARNING	1-7
Radio Tag Technology	1-7
Other precautions (for users in California, the United States)	1-7
Warranty (the United States and Canada)	1-8
Legal Restriction on Copying/Scanning	1-9
EN ISO 7779	1-9
EK1-ITB 2000	1-9
Legal Information	1-10
Energy Saving Control Function	1-16
Automatic 2-Sided Copy Function	1-16
Resource Saving - Paper	1-16
Environmental benefits of "Power Management"	1-16
Energy Star (ENERGY STAR®) Program	1-17

2 Installing and Setting up the Machine 2-1

Part Names	2-2
Machine Exterior	2-2
Connectors/Interior	2-4
With Optional Equipments Attached	2-5
Determining the Connection Method and Preparing Cables	2-6
Connection Example	2-6
Preparing Necessary Cables	2-7
Connecting Cables	2-8
Connecting LAN Cable	2-8
Connecting USB Cable	2-9
Connecting the Power Cable	2-9
Power On/Off	2-10
Power On	2-10
Power Off	2-11
Installing Software	2-13
Software on DVD (Windows)	2-13
Installing Printer Driver in Windows	2-14
Uninstalling the Software	2-16
Installing Printer Driver in Macintosh	2-17
Setting TWAIN Driver	2-19

Setting WIA Driver	2-20
Login/Logout	2-21
Login	2-21
Logout	2-22
Default Settings of the Machine	2-23
Setting Date and Time	2-23
Network Setup (LAN Cable Connection)	2-25
Quick Setup Wizard	2-28
Checking the Counter	2-30
Additional Preparations for the Administrator	2-31
To Send Documents to a PC	2-31
To E-mail Scanned Images	2-31
To Strengthen the Security	2-31
Command Center RX	2-33
Accessing Command Center RX	2-34
Changing Security Settings	2-35
Changing Device Information	2-36
E-mail settings	2-37
Registering Destinations	2-40
Registering a Custom Box	2-41
Printing a document stored in a Custom Box	2-42
Transferring data from our other products	2-44
Migrating the Address Book	2-44

3 Preparation before Use3-1

Using the Operation Panel	3-2
Operation Panel Keys	3-2
Adjusting the Operation Panel Angle	3-3
Touch Panel Display	3-4
Home Screen	3-4
Display for Originals and Paper	3-8
Display of keys that cannot be set	3-8
Original Preview	3-9
Enter key and Quick No. Search key	3-11
Help Screen	3-12
Accessibility Functions (Magnifying the View)	3-13
Energy Saver function	3-14
Low Power Mode and Auto Low Power Mode	3-14
Sleep and Auto Sleep	3-15
Loading Paper	3-16
Before Loading Paper	3-17
Loading in the Cassettes	3-18
Loading Paper in the Multi Purpose Tray	3-26
Paper stopper	3-30
Specifying Paper Size and Media	3-31
Preparation for Sending a Document to a PC	3-36
Making a note of the computer name and full computer name	3-36
Making a note of the user name and domain name	3-37
Creating a Shared Folder, Making a Note of a Shared Folder	3-38
Configuring Windows Firewall (for Windows 7)	3-42
Registering Destinations in the Address Book	3-46
Adding a Destination (Address Book)	3-46
Adding a Destination on One Touch Key (One Touch Key)	3-54

4 Printing from PC4-1

Printing from PC	4-2
Printer driver print settings screen	4-5
Printer Driver Help	4-6

Changing the default printer driver settings (Windows 7)	4-6
Canceling printing from a computer	4-6
Banner printing	4-7
Printing Data Saved on the Printer	4-14
Private Print/Stored Job	4-14
Quick Copy/Proof and Hold	4-16

5 Operation on the Machine5-1

Loading Originals	5-2
Placing Originals on the Platen	5-2
Loading Originals in the Document Processor	5-3
Checking the Equipment's Serial Number	5-5
Program	5-6
Registering Programs	5-7
Recalling Programs	5-7
Editing and Deleting Programs	5-9
Application	5-10
Installing Applications	5-10
Activating/Deactivating Application	5-11
Deleting Applications	5-13
Registering Shortcuts (Copy, Send, and Document Box Settings)	5-14
Adding Shortcuts	5-14
Editing and Deleting Shortcuts	5-15
Using the Internet Browser	5-16
Launching and Exiting the Browser	5-16
Using the Browser Screen	5-17
Canceling Jobs	5-18
Canceling Jobs	5-18
Canceling printing from a computer	5-19
Copying	5-20
Basic Operation	5-20
Reserve Next	5-21
Interrupt Copy	5-22
Sending	5-23
Basic Operation	5-24
Specifying Destination	5-26
Checking and Editing Destinations	5-34
Confirmation Screen of Destinations	5-35
Sending to Different Types of Destinations (Multi Sending)	5-36
WSD Scan/DSM Scan	5-37
Scanning using TWAIN	5-41
Scanning a document placed in the machine	5-41
Scanning a document stored in a custom box	5-43
Scanning with FMU Connection	5-45
Using FMU Connection to scan an original	5-45
How to use the FAX Function	5-46
What is Document Box?	5-47
Basic Operation for Document Box	5-48
Using a Custom Box	5-53
Creating a New Custom Box (Add/Edit Box)	5-53
Editing Custom Box	5-55
Deleting Custom Boxes	5-55
Storing Documents (Store File)	5-56
Printing Documents (Print)	5-57
Sending Documents (Send)	5-58
Editing Documents	5-60
Deleting Documents	5-64
Job Box	5-65
Outputting Repeat Copy Jobs	5-65

Form for Form Overlay	5-66
Printing Documents Stored in Removable USB Memory	5-68
Saving Documents to USB Memory (Scan to USB)	5-70
Check the USB memory information	5-71
Removing USB Memory	5-72
Manual Staple	5-73

6 Using Various Functions6-1

Functions Available on the Machine	6-2
Copy	6-2
Send	6-4
Custom Box (Store File, Printing, Send)	6-6
Removable Memory (Store File, Printing Documents)	6-9
Functions	6-11
Original Size	6-11
Paper Selection	6-12
Mixed Size Originals	6-13
Original Orientation	6-15
Fold	6-16
Collate/Offset	6-17
Staple/Punch	6-18
Paper Output	6-21
Density	6-21
Original Image	6-22
EcoPrint	6-23
Color Selection	6-23
Sharpness	6-24
Background Density Adj.	6-24
Prevent Bleed-thru	6-25
Zoom	6-26
Combine	6-30
Margin/Centering, Margin, Centering	6-32
Border Erase	6-33
Booklet	6-35
Duplex	6-38
Cover	6-41
Form Overlay	6-42
Page #	6-43
Memo Page	6-45
Image Repeat	6-46
Text Stamp	6-47
Bates Stamp	6-49
Continuous Scan	6-51
Auto Image Rotation	6-52
Negative Image	6-52
Mirror Image	6-52
Job Finish Notice	6-53
File Name Entry	6-53
Priority Override	6-54
Repeat Copy	6-54
DP Read Action	6-55
Skip Blank Page	6-55
2-sided/Book Original, Book Original	6-56
Sending Size	6-57
File Format	6-58
File Separation	6-61
Scan Resolution, Resolution	6-61
E-mail Subject/Body	6-61
Send and Print	6-62

	Send and Store	6-62
	FTP Encrypted TX	6-63
	File Size Confirmation	6-63
	Delete after Printed	6-63
	Delete after Transmitted	6-63
	Storing Size	6-64
	Encrypted PDF Password	6-64
	JPEG/TIFF Print	6-65
	XPS Fit to Page	6-65
	Functions Available in the Home Screen	6-66
	Send to Me (E-mail)	6-66
	Send to Me from Box (E-mail)	6-66
7	Status/Job Cancel	7-1
	Checking Job Status	7-2
	Details of the Status Screens	7-4
	Checking Detailed Information of Jobs	7-9
	Checking Job History	7-11
	Checking the Detailed Information of Histories	7-13
	Sending the Log History	7-13
	Pause and Resumption of Jobs	7-14
	Canceling of Jobs	7-14
	Priority Override for Waiting Jobs	7-15
	Reordering Print Jobs	7-16
	Device/Communication	7-17
	Checking the Remaining Amount of Toner and Paper (Paper/Supplies)	7-18
8	Setup and Registration (System Menu)	8-1
	System Menu	8-2
	Operation Method	8-2
	System Menu Settings	8-4
	Cassette/MP Tray Settings	8-7
	Common Settings	8-9
	Home	8-28
	Copy	8-28
	Send	8-29
	Document Box/Removable Memory	8-34
	FAX	8-35
	Printer	8-35
	Report	8-37
	System/Network	8-43
	Edit Destination	8-53
	User Login/Job Accounting	8-53
	User Property	8-54
	Date/Timer/Energy Saver	8-54
	Adjustment/Maintenance	8-57
	Internet	8-60
	Application	8-60
9	User Authentication and Accounting (User Login, Job Accounting)	9-1
	User Login	9-2
	First User Login Administration	9-2
	User Login Setting	9-2
	User Login	9-4
	Authentication Security	9-6
	Adding a User (Local User List)	9-8
	Changing User Properties	9-11

	Local Authorization	9-15
	Group Authorization Set.	9-15
	Guest Authorization Set.	9-18
	Obtain NW User Property	9-21
	Simple Login Settings	9-23
	ID Card Settings	9-26
	Job Accounting Setting	9-27
	First Job Accounting Setup	9-27
	Job Accounting Setting	9-27
	Job Accounting	9-29
	Login/Logout	9-29
	Job Accounting Access	9-30
	Job Accounting (Local)	9-31
	Accounting List	9-32
	Managing Accounts	9-33
	Default Setting	9-36
	Counting the Number of Pages Printed	9-38
	Apply Limit	9-40
	Copier/Printer Count	9-40
	Unknown ID Job	9-41
10	Troubleshooting	10-1
	Regular Maintenance	10-2
	Cleaning	10-2
	Toner Container Replacement	10-6
	Waste Toner Box Replacement	10-9
	Replacing Staples	10-12
	Disposing of the Punch Waste	10-16
	Troubleshooting	10-18
	Solving Malfunctions	10-18
	Responding to Messages	10-23
	Adjustment/Maintenance	10-36
	Clearing Paper Jams	10-39
	Clearing a Staple Jam	10-63
11	Appendix	11-1
	Optional Equipment	11-2
	Overview of Optional Equipment	11-2
	Optional Applications	11-8
	Character Entry Method	11-10
	Entry Screens	11-10
	Entering Characters	11-12
	Paper	11-13
	Basic Paper Specifications	11-13
	Choosing the Appropriate Paper	11-14
	Special Paper	11-17
	Specifications	11-22
	Common functions	11-22
	Copy functions	11-24
	Printer functions	11-25
	Scanner functions	11-25
	Document Processor (Option)	11-26
	Paper Feeder (500-sheet x 2) (Option)	11-26
	Large Capacity Feeder (1,500-sheet x 2) (Option)	11-27
	Side Feeder (3,000-sheet) (Option)	11-27
	1,000-Sheet Finisher (Option)	11-28
	4,000-Sheet Finisher (Option)	11-29
	Hole Punch Unit (Option)	11-29

Mailbox (Option)	11-30
Center-Folding Unit (Option)	11-30
Inner Job Separator (Option)	11-31
Inner Job Separator (JS-732) (Option)	11-31
Right Job Separator (Option)	11-32
Banner Tray (Option)	11-32
Glossary	11-33
Index	Index-1

Menu Map

(The names displayed on the touch panel are used here. These may differ from the referenced titles.)

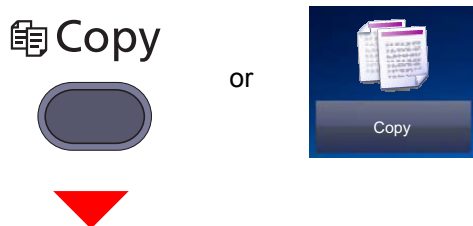

Org./Paper/Finishing	Original Size (page 6-11)	
	Paper Selection (page 6-12)	
	Mixed Size Originals (page 6-13)	
	Original Orientation (page 6-15)	
	Fold (page 6-16)	
	Collate/Offset (page 6-17)	
	Staple/Punch	Staple (page 6-18)
		Punch (page 6-19)
Image Quality	Paper Output (page 6-21)	
	Density (page 6-21)	
	Original Image (page 6-22)	
	EcoPrint (page 6-23)	
	Sharpness (page 6-24)	
	Background Density Adj. (page 6-24)	
Layout/Edit	Prevent Bleed-thru (page 6-25)	
	Zoom (page 6-26)	
	Combine (page 6-30)	
	Margin/Centering (page 6-32)	
	Border Erase (page 6-33)	
	Booklet (page 6-35)	
	Duplex (page 6-38)	
	Cover (page 6-41)	
Form Overlay (page 6-42)		

Layout/Edit	Page # (page 6-43)
	Memo Page (page 6-45)
	Image Repeat (page 6-46)
	Text Stamp (page 6-47)
	Bates Stamp (page 6-49)
Advanced Setup	Continuous Scan (page 6-51)
	Auto Image Rotation (page 6-52)
	Negative Image (page 6-52)
	Mirror Image (page 6-52)
	Job Finish Notice (page 6-53)
	File Name Entry (page 6-53)
	Priority Override (page 6-54)
	Repeat Copy (page 6-54)
	DP Read Action (page 6-55)
	Skip Blank Page (page 6-55)
Program (page 5-6)	

 Send

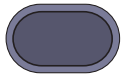

or

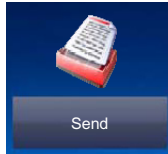

Destination	Address Book (page 5-26)
	E-mail Addr Entry (page 5-29)
	Folder Path Entry (page 5-31)
	FAX No. Entry (refer to FAX Operation Guide)
	i-FAX Address Entry (refer to FAX Operation Guide)
	WSD Scan/DSM Scan (page 5-37)
Org./Sending Data Format	Original Size (page 6-11)
	Mixed Size Originals (page 6-13)
	2-sided/Book Original, Book Original (page 6-56)
	Original Orientation (page 6-15)
	Sending Size (page 6-57)
	File Format (page 6-58)
	File Separation (page 6-61)
	Long Original (refer to FAX Operation Guide)
Color/Image Quality	Density (page 6-21)
	Original Image (page 6-22)
	Scan Resolution (page 6-61)
	FAX TX Resolution (refer to FAX Operation Guide)
	Color Selection (page 6-23)
	Sharpness (page 6-24)
	Background Density Adj. (page 6-24)
	Prevent Bleed-thru (page 6-25)

Advanced Setup	Zoom (page 6-26)
	Centering (page 6-32)
	Border Erase (page 6-33)
	FAX Delayed Transmission (refer to FAX Operation Guide)
	Continuous Scan (page 6-51)
	Job Finish Notice (page 6-53)
	File Name Entry (page 6-53)
	E-mail Subject/Body (page 6-61)
	i-FAX Subject/Body (refer to FAX Operation Guide)
	FAX Direct Transmission (refer to FAX Operation Guide)
	FAX Polling RX (refer to FAX Operation Guide)
	Send and Print (page 6-62)
	Send and Store (page 6-62)
	FTP Encrypted TX (page 6-63)
	Text Stamp (page 6-47)
	Bates Stamp (page 6-49)
File Size Confirmation (page 6-63)	
FAX TX Report (refer to FAX Operation Guide)	
Program (page 5-6)	

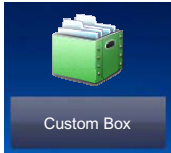

Custom Box	Store File	Functions	Original Size (page 6-11)
			Mixed Size Originals (page 6-13)
			2-sided/Book Original, Book Original (page 6-56)
			Original Orientation (page 6-15)
			Storing Size (page 6-64)
			Prevent Bleed-thru (page 6-25)
			Density (page 6-21)
			Original Image (page 6-22)
			Scan Resolution (page 6-61)
			Color Selection (page 6-23)
			Sharpness (page 6-24)
			Background Density Adj. (page 6-24)
			Zoom (page 6-26)
			Centering (page 6-32)
			Border Erase (page 6-33)
			Continuous Scan (page 6-51)
		Job Finish Notice (page 6-53)	
File Name Entry (page 6-53)			
Program (page 5-6)			
Detail (page 5-48)			

Custom Box	Open	Print	Functions	Paper Selection (page 6-12)	
				Collate/Offset (page 6-17)	
				Staple/Punch (page 6-18)	Staple (page 6-18)
					Punch (page 6-19)
				Paper Output (page 6-21)	
				Combine (page 6-30)	
				Margin/Centering (page 6-32)	
				Booklet (page 6-35)	
				Printing (page 6-40)	
				Cover (page 6-41)	
				Form Overlay (page 6-42)	
				Page # (page 6-43)	
				Job Finish Notice (page 6-53)	
				File Name Entry (page 6-53)	
				Delete after Printed (page 6-63)	
				Priority Override (page 6-54)	
				EcoPrint (page 6-23)	
				Zoom (page 6-26)	
				Fold (page 6-16)	
				Text Stamp (page 6-47)	
			Bates Stamp (page 6-49)		
			Image Quality	Density (page 6-21)	
				Original Image (page 6-22)	
				Sharpness (page 6-24)	
				Background Density Adj. (page 6-24)	
				Prevent Bleed-thru (page 6-25)	
			Program (page 5-6)		

Custom Box	Open	Send	Destination (page 5-26)	
			Functions	Sending Size (page 6-57)
				File Format (page 6-58)
				FAX TX Resolution (refer to FAX Operation Guide)
				Centering (page 6-32)
				FAX Delayed Transmission (refer to FAX Operation Guide)
				Job Finish Notice (page 6-53)
				File Name Entry (page 6-53)
				E-mail Subject/Body (page 6-61)
				i-FAX Subject/Body (refer to FAX Operation Guide)
				FTP Encrypted TX (page 6-63)
				Delete after Transmitted (page 6-63)
				Zoom (page 6-26)
				File Separation (page 6-61)
				Text Stamp (page 6-47)
				Bates Stamp (page 6-49)
				File Size Confirmation (page 6-63)
				FAX TX Report (refer to FAX Operation Guide)
				Color/Image Quality
			Original Image (page 6-22)	
			Resolution (page 6-61)	
			Color Selection (page 6-23)	
			Sharpness (page 6-24)	
			Background Density Adj. (page 6-24)	
			Prevent Bleed-thru (page 6-25)	
			Program (page 5-6)	
			Join (page 5-62)	
Move/Copy (page 5-60)				
Delete (page 5-67)				
Store File (page 5-56)				
Search(Name) (page 5-48)				
Page Selection (page 5-48)				
Detail (page 5-48)				
Preview (page 5-51)				
Search(No.) (page 5-48)				
Search(Name) (page 5-48)				
Add/Edit Box (page 5-53)				

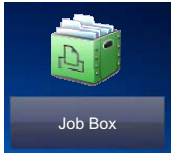

Job Box	Private Print/Stored Job (page 4-14)
	Quick Copy/Proof and Hold (page 4-16)
	Repeat Copy (page 6-54)
	Form for Form Overlay (page 5-66)



Removable Memory	Print	Functions	
			Paper Selection (page 6-12)
			Collate/Offset (page 6-17)
			Staple/Punch (page 6-18)
			Staple (page 6-18)
			Punch (page 6-19)
			Paper Output (page 6-21)
			Margin (page 6-32)
			Duplex (page 6-38)
			Job Finish Notice (page 6-53)
			Priority Override (page 6-54)
			EcoPrint (page 6-23)
			Fold (page 6-16)
			Text Stamp (page 6-47)
			Bates Stamp (page 6-49)
			Encrypted PDF Password (page 6-64)
			JPEG/TIFF Print (page 6-65)
			XPS Fit to Page (page 6-65)

Removable Memory	Store File	Functions	
			Original Size (page 6-11)
			Mixed Size Originals (page 6-13)
			2-sided/Book Original, Book Original (page 6-56)
			Original Orientation (page 6-15)
			Storing Size (page 6-64)
			Prevent Bleed-thru (page 6-25)
			Density (page 6-21)
			Original Image (page 6-22)
			Scan Resolution (page 6-61)
			Color Selection (page 6-23)
			Sharpness (page 6-24)
			Background Density Adj. (page 6-24)
			Zoom (page 6-26)
			Centering (page 6-32)
			Border Erase (page 6-33)
			Continuous Scan (page 6-51)
			Job Finish Notice (page 6-53)
			File Name Entry (page 6-53)
			File Format (page 6-58)
			File Separation (page 6-61)
			Text Stamp (page 6-47)
			Bates Stamp (page 6-49)
			Delete (page 5-49)
			Detail (page 5-48)
			Memory Information (page 5-71)
			Remove Memory (page 5-72)
			FAX Box (refer to FAX Operation Guide)

Status/
Job Cancel



or

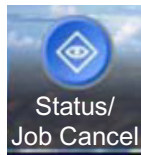

Printing Jobs (page 7-4)
Sending Jobs (page 7-6)
Storing Jobs (page 7-7)
Device/Communication (page 7-17)
Paper/Supplies (page 7-18)

System Menu



or

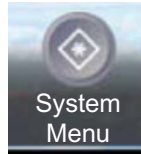

Quick Setup Wizard	FAX Setup (page 2-28)		
	Energy Saver Setup (page 2-28)		
Cassette/MP Tray Settings	Cassette 1 (page 8-7)		
	Cassette 2 (page 8-7)		
	Cassette 3 (page 8-7)		
	Cassette 4 (page 8-7)		
	Cassette 5 (page 8-7)		
	MP Tray Setting (page 8-8)		
Common Settings	Language (page 8-9)		
	Default Screen (page 8-9)		
	Sound	Buzzer (page 8-9)	
		FAX Speaker Volume (refer to FAX Operation Guide)	
		FAX Monitor Volume (refer to FAX Operation Guide)	
	Keyboard Layout (page 8-10)		
	Original/Paper Settings	Custom Original Size (page 8-10)	
		Custom Paper Size (page 8-10)	
		Media Type Setting (page 8-10)	
		Default Paper Source (page 8-11)	
		Auto Detect Original Size (page 8-11)	
		Media for Auto (B&W) (page 8-11)	
		Paper Source for Cover (page 8-12)	
Special Paper Action (page 8-12)			
Measurement (page 8-14)			

Common Settings	Error Handling	Duplexing Error (page 8-14)
		Finishing Error (page 8-14)
		No Staple Error (page 8-14)
		Finished Pages Exceeded (page 8-14)
		Punch Waste Full Error (page 8-15)
		Paper Mismatch Error (page 8-15)
		Inserted Paper Mismatch (page 8-15)
		Paper Jam before Staple (page 8-15)
	Paper Output (page 8-16)	
	Orientation Confirmation (page 8-16)	
	Function Defaults	Original Orientation (page 8-17)
		Original Image (Copy) (page 8-17)
		Org. Image (Send/Store) (page 8-17)
		Scan Resolution (page 8-17)
		FAX TX Resolution (refer to FAX Operation Guide)
		Color Selection (page 8-17)
		File Format (page 8-17)
		File Separation (page 8-17)
		Backgrnd Density (Copy) (page 8-17)
		BackgrndDens.(Send/Store) (page 8-17)
		Prevent Bleed-thru (Copy) (page 8-17)
		Prevent Bleed(Send/Store) (page 8-17)
		Zoom (page 8-17)
		Border Erase Default (page 8-17)
		Border Erase to Back Page (page 8-17)
		Margin Default (page 8-18)
		Auto Image Rotation (Copy) (page 8-18)
EcoPrint (page 8-18)		
Toner Save Level (EcoPrint) (page 8-18)		
High Comp. PDF Image (page 8-18)		

Common Settings	Function Defaults	Color TIFF Compression (page 8-18)
		Image Quality (File Format) (page 8-18)
		Collate/Offset (page 8-18)
		JPEG/TIFF Print (page 8-18)
		XPS Fit to Page (page 8-18)
		PDF/A (page 8-18)
		Cont. Scan (Except FAX) (page 8-18)
		Continuous Scan (FAX) (refer to FAX Operation Guide)
		File Name Entry (page 8-18)
		E-mail Subject/Body (page 8-19)
		i-FAX Subject/Body (page 8-19)
		DP Read Action (page 8-19)
		OCR Text Recognition (page 8-19)
		Primary OCR Language (page 8-19)
		Auto Image Rotation (OCR) (page 8-19)
	Repeat Copy (page 8-20)	
	Skip Blank Page (page 8-20)	
	USB Keyboard Type (page 8-20)	
	System Stamp (page 8-20)	
	Manual Staple (page 8-24)	
	Offset Documents by Job (page 8-24)	
	Low Toner Alert Level (page 8-24)	
	Offset One Page Documents (page 8-25)	
Display Status/Log (page 8-25)		
Message Banner Print (page 8-25)		
Customize Status Display (page 8-26)		
Function Key Usage (page 8-26)		
Message Board Settings (page 8-27)		
Remote Printing (page 8-27)		
Home	Customize Desktop (page 3-5)	
	Customize Taskbar (page 3-5)	
	Wallpaper (page 3-5)	

Copy	Paper Selection (page 8-28)	
	Auto Image Rotation Action (page 8-28)	
	Auto Paper Selection (page 8-28)	
	Auto % Priority (page 8-28)	
	Paper Size for Small Original (page 8-28)	
	Preset Limit (page 8-28)	
	Reserve Next Priority (page 8-29)	
	Quick Setup Registration (page 8-29)	
Send	Quick Setup Registration (page 8-29)	
	Dest. Check before Send (page 8-29)	
	Color Type (page 8-29)	
	Entry Check for New Dest. (page 8-29)	
	Default Screen (page 8-29)	
	Send and Forward (page 8-30)	
	New Destination Entry (page 8-30)	
	Recall Destination (page 8-30)	
	OCR Text Recognition Act. (page 8-30)	
	HighCompressionPDF Mode (page 8-30)	
Document Box/Removable Memory	Custom Box (page 5-53)	
	FAX Box (refer to FAX Operation Guide)	
	Job Box	Quick Copy Job Retention (page 8-34)
		Repeat Copy Job Retention (page 8-34)
		Deletion of Job Retention (page 8-34)
	Polling Box (refer to FAX Operation Guide)	
Quick Setup Registration (page 8-34)		
FAX (refer to FAX Operation Guide)		

Printer	Emulation (page 8-35)	
	EcoPrint (page 8-35)	
	Toner Save Level (EcoPrint) (page 8-35)	
	Override A4/Letter (page 8-35)	
	Duplex (page 8-35)	
	Copies (page 8-35)	
	Orientation (page 8-36)	
	Form Feed Timeout (page 8-36)	
	LF Action (page 8-36)	
	CR Action (page 8-36)	
	Job Name (page 8-36)	
	User Name (page 8-36)	
	Paper Feed Mode (page 8-36)	
	KIR (page 8-36)	
Report	Print Report	Status Page (page 8-37)
		Font List (page 8-37)
		Network Status (page 8-37)
		Service Status (page 8-38)
		Optional Network Status (page 8-38)
	Admin Report Settings	Outgoing FAX Report (refer to FAX Operation Guide)
		Incoming FAX Report (refer to FAX Operation Guide)
	Result Report Settings	Send Result Report (page 8-38)
		FAX RX Result Report (refer to FAX Operation Guide)
		Job Finish Notice Setting (refer to FAX Operation Guide)
		RX Result Report Type (refer to FAX Operation Guide)
	Sending Log History	Auto Sending (page 8-39)
		Sending Log History (page 8-39)
		Destination (page 8-39)
		Job Log Subject (page 8-39)
		Personal Information (page 8-39)

Report	Login History Settings	Login History (page 8-40)	
		Auto Sending (page 8-40)	
		Destination (page 8-40)	
		Subject (page 8-40)	
		Log Reset (page 8-40)	
	Device Log History Settings	Device Log History (page 8-41)	
		Auto Sending (page 8-41)	
		Destination (page 8-41)	
		Subject (page 8-41)	
	Secure Comm. Error Log	Secure Comm. Error Log (page 8-42)	
		Auto Sending (page 8-42)	
		Destination (page 8-42)	
		Subject (page 8-42)	
System/Network	Network	Host Name (page 8-43)	
		TCP/IP Setting	TCP/IP (page 8-43)
			IPv4 (page 8-43)
			IPv6 (page 8-44)
			Bonjour (page 8-44)
			IPSec (page 8-44)
		Protocol Settings	SMTP (E-mail TX) (page 8-45)
			POP3 (E-mail RX) (page 8-45)
			FTP Client (Transmission) (page 8-45)
			FTP Server (Reception) (page 8-45)
			SMB Client (Transmission): (page 8-45)
			NetBEUI (page 8-45)
			WSD Scan (page 8-45)
			WSD Print (page 8-45)
			i-FAX (page 8-45)
			DSM Scan (page 8-45)
			ThinPrint (page 8-45)
			LPD (page 8-45)
			Raw (page 8-45)
			IPP (page 8-45)
IPP over SSL (page 8-45)			
HTTP (page 8-46)			
HTTPS (page 8-46)			

System/Network	Network	Protocol Settings	LDAP (page 8-46)
			SNMPv1/v2c (page 8-46)
			SNMPv3 (page 8-46)
			Enhanced WSD (page 8-46)
			Enhanced WSD over SSL (page 8-46)
		Security Settings (page 8-46)	
		LAN Interface (page 8-46)	
		Restart Network (page 8-46)	
		Proxy (page 8-47)	
		Optional Network	Network Interface (Send) (page 8-49)
	Wireless Network (page 8-48)		
	Network Interface (Send) (page 8-49)		
	Security Level (page 8-49)		
	Interface Block Setting	USB Host (page 8-50)	
		USB Device (page 8-50)	
		USB Storage (page 8-50)	
		Optional Interface 1 (page 8-50)	
		Optional Interface 2 (page 8-50)	
	Data Security (page 8-50)		
	Document Guard (page 8-51)		
	Optional Function (page 8-52)		
	Restart Entire Device (page 8-52)		
	Edit Destination	Address Book (page 3-46)	
One Touch Key (page 3-54)			
Print List (refer to FAX Operation Guide)			
Address Book Defaults		Sort (page 8-53)	
		Narrow Down (page 8-53)	
		Address Book Type (page 8-53)	

User Login/Job Accounting	User Login Setting	User Login (page 9-4)	
		Authentication Security	User Account Lockout Set. (page 9-6)
			Password Policy Settings (page 9-7)
		Local User List (page 9-8)	
		Local Authorization (page 9-15)	
		Group Authorization Set.	Group Authorization (page 9-15)
			Group List (page 9-16)
		Guest Authorization Set.	Guest Authorization (page 9-18)
			Guest Property (page 9-18)
		Obtain NW User Property (page 9-21)	
		Simple Login Settings	Simple Login (page 9-23)
			Simple Login Key (page 9-23)
		ID Card Settings	Keyboard Login (page 9-26)
			Password Login (page 9-26)
	Job Accounting Setting	Job Accounting (page 9-29)	
		Job Accounting Access (page 9-30)	
		Job Accounting (Local)	Print Accounting Report (page 9-31)
			Total Job Accounting (page 9-38)
			Each Job Accounting (page 9-39)
			Accounting List (page 9-32)
Default Setting (page 9-36)			
Apply Limit (page 9-40)			
Copier/Printer Count (page 9-40)			
Unknown ID Job (page 9-41)			
User Property (page 9-11)			

Date/Timer/Energy Saver	Date/Time (page 8-54)	
	Date Format (page 8-54)	
	Time Zone (page 8-54)	
	Auto Panel Reset (page 8-54)	
	Auto Error Clear (page 8-54)	
	Low Power Timer (page 8-54)	
	Panel Reset Timer (page 8-55)	
	Sleep Timer (page 8-55)	
	Interrupt Clear Timer (page 8-55)	
	Error Job Skip (page 8-55)	
	Error Clear Timer (page 8-55)	
	Unusable Time (refer to FAX Operation Guide)	
	Sleep Rules (models for Europe) (page 8-55)	
	Sleep Level (models except for Europe) (page 8-56)	
	EnergySaver RecoveryLevel (page 8-56)	
Weekly Timer Settings (page 8-56)		
Adjustment/Maintenance	Density Adjustment	Copy (page 8-57)
		Send/Box (page 8-57)
		FAX (refer to FAX Operation Guide)
	Background Density Adj.	Copy (Auto) (page 8-57)
		Send/Box (Auto) (page 8-57)
	Correcting Black Lines (page 8-57)	
	System Initialization (page 8-57)	
	Display Brightness (page 8-57)	
	Silent Mode (page 8-57)	
	Memory Diagnostics (page 8-57)	
	Auto Color Correction (page 8-58)	
	Tone Curve Adjustment (page 8-58)	
	Drum Refresh 1 (page 8-58)	
	Drum Refresh 2 (page 8-58)	
	Developer Refresh (page 8-58)	
	Calibration Cycle (page 8-58)	
	Calibration (page 8-59)	
Correct Paper Curl (page 8-59)		
Internet (page 8-60)		
Application (page 8-60)		

1 Legal and Safety Information

Please read this information before using your machine. This chapter provides information on the following topics.

Notice	1-2
Safety Conventions in This Guide	1-2
Environment	1-3
Precautions for Use	1-4
Laser Safety (Europe)	1-5
SAFETY OF LASER BEAM (USA)	1-6
Safety Instructions Regarding the Disconnection of Power	1-7
WARNING	1-7
Radio Tag Technology	1-7
Other precautions (for users in California, the United States)	1-7
Warranty (the United States and Canada)	1-8
Legal Restriction on Copying/Scanning	1-9
EN ISO 7779	1-9
EK1-ITB 2000	1-9
Legal Information	1-10
Energy Saving Control Function	1-16
Automatic 2-Sided Copy Function	1-16
Resource Saving - Paper	1-16
Environmental benefits of "Power Management"	1-16
Energy Star (ENERGY STAR®) Program	1-17

Notice

Safety Conventions in This Guide

The sections of this guide and parts of the machine marked with symbols are safety warnings meant to protect the user, other individuals and surrounding objects, and ensure correct and safe usage of the machine. The symbols and their meanings are indicated below.

 **WARNING:** Indicates that serious injury or even death may result from insufficient attention to or incorrect compliance with the related points.

 **CAUTION:** Indicates that personal injury or mechanical damage may result from insufficient attention to or incorrect compliance with the related points.

Symbols

The  symbol indicates that the related section includes safety warnings. Specific points of attention are indicated inside the symbol.

 ... [General warning]

 ... [Warning of high temperature]

The  symbol indicates that the related section includes information on prohibited actions. Specifics of the prohibited action are indicated inside the symbol.

 ... [Warning of prohibited action]

 ... [Disassembly prohibited]

The  symbol indicates that the related section includes information on actions which must be performed. Specifics of the required action are indicated inside the symbol.

 ... [Alert of required action]

 ... [Remove the power plug from the outlet]

 ... [Always connect the machine to an outlet with a ground connection]

Please contact your service representative to order a replacement if the safety warnings in this Operation Guide are illegible or if the guide itself is missing (fee required).

NOTE

An original which resembles a bank note closely may not be copied properly in some rare cases because this machine is equipped with a counterfeiting prevention function.

Environment

The service environmental conditions are as follows:

- Temperature: 50 to 90.5 °F (10 to 32.5 °C)
(But humidity should be 70% or less when temperature is 90.5 °F (32.5 °C).)
- Humidity: 15 to 80%
(But temperature should be 86 °F (30 °C) or less when humidity is 80%.)

Use coated paper at a temperature of 80.6 °F (27°C) or less and a humidity of 60% or less.

Adverse environmental conditions may affect the image quality. It is recommended to use the machine at a temperature: around 60.8 to 80.6 °F or less (16 to 27 °C), humidity: around 36 to 65%. In addition, avoid the following locations when selecting a site for the machine.

The machine automatically detects and displays the following message when the environmental temperature is too high or too low.

Message: "Warning for high temperature. Adjust the room temperature." or "Warning for low temperature. Adjust the room temperature."

To use the machine under optimum conditions, adjust the temperature and the humidity of your room if the message is displayed.

- Avoid locations near a window or with exposure to direct sunlight.
- Avoid locations with vibrations.
- Avoid locations with drastic temperature fluctuations.
- Avoid locations with direct exposure to hot or cold air.
- Avoid poorly ventilated locations.

If the floor is delicate against casters, when this machine is moved after installation, the floor material may be damaged.

During copying, some ozone is released, but the amount does not cause any ill effect to one's health. If, however, the machine is used over a long period of time in a poorly ventilated room or when making an extremely large number of copies, the smell may become unpleasant. To maintain the appropriate environment for copy work, it is suggested that the room be properly ventilated.

Precautions for Use

Cautions when handling consumables

CAUTION

Do not attempt to incinerate parts which contain toner. Dangerous sparks may cause burns.

Keep parts which contain toner out of the reach of children.

If toner happens to spill from parts which contain toner, avoid inhalation and ingestion, as well as contact with your eyes and skin.

- If you do happen to inhale toner, move to a place with fresh air and gargle thoroughly with a large amount of water. If coughing develops, contact a physician.
- If you do happen to ingest toner, rinse your mouth with water and drink 1 or 2 cups of water to dilute the contents of your stomach. If necessary, contact a physician.
- If you do happen to get toner in your eyes, flush them thoroughly with water. If there is any remaining tenderness, contact a physician.
- If toner does happen to get on your skin, wash with soap and water.

Do not attempt to force open or destroy parts which contain toner.

Other precautions

Return the exhausted toner container and waste toner box to your dealer or service representative. The collected toner container and waste toner box will be recycled or disposed in accordance with the relevant regulations.

Store the machine while avoiding exposure to direct sunlight.

Store the machine in a place where the temperature stays below 40 °C while avoiding sharp changes of temperature and humidity.

If the machine will not be used for an extended period of time, remove the paper from the cassette and the Multi Purpose (MP) Tray, return it to its original package and reseal it.

Laser Safety (Europe)

Laser radiation could be hazardous to the human body. For this reason, laser radiation emitted inside this machine is hermetically sealed within the protective housing and external cover. In the normal operation of the product by user, no radiation can leak from the machine.

This machine is classified as Class 1 laser product under IEC/EN 60825-1:2007.

Caution: Performance of procedures other than those specified in this manual may result in hazardous radiation exposure.

These labels are attached to the laser scanner unit inside the machine and are not in a user access area.

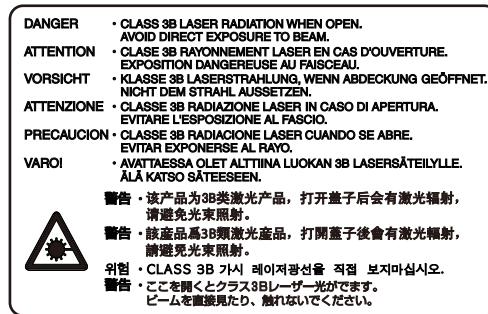

Regarding CLASS 1 laser products, information is provided on the rating label.

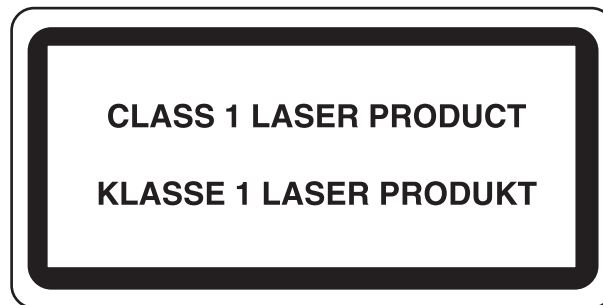

SAFETY OF LASER BEAM (USA)

1. Safety of laser beam

This machine has been certified by the manufacturer to Class 1 level under the radiation performance standards established by the U.S.DHHS (Department of Health and Human Services) in 1968. This indicates that the product is safe to use during normal operation and maintenance. The laser optical system, enclosed in a protective housing and sealed within the external covers, never permits the laser beam to escape.

2. The CDRH Act

A laser-product-related act was implemented on Aug. 2, 1976, by the Center for Devices and Radiological Health (CDRH) of the U.S. Food and Drug Administration (FDA). This act prohibits the sale of laser products in the U.S. without certification, and applies to laser products manufactured after Aug. 1, 1976. The label shown below indicates compliance with the CDRH regulations and must be attached to laser products marketed in the United States. On this machine, the label is on the right.

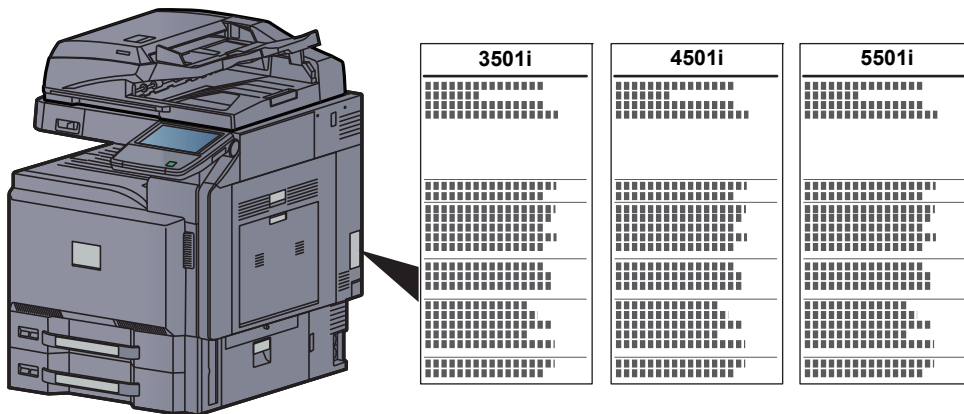

3. Optical unit

When checking the optical unit, avoid direct exposure to the laser beam, which is invisible. Shown at below is the label located on the cover of the optical unit.

DANGER	• CLASS 3B LASER RADIATION WHEN OPEN. AVOID DIRECT EXPOSURE TO BEAM.
ATTENTION	• CLASSE 3B RAYONNEMENT LASER EN CAS D'OUVERTURE. EXPOSITION DANGEREUSE AU FAISCEAU.
VORSICHT	• KLASSE 3B LASERSTRAHLUNG, WENN ABDECKUNG GEÖFFNET. NICHT DEM STRAHL AUSSETZEN.
ATTENZIONE	• CLASSE 3B RADIAZIONE LASER IN CASO DI APERTURA. EVITARE L'ESPOSIZIONE AL FASCIO.
PRECAUCION	• CLASSE 3B RADIACIONE LASER CUANDO SE ABRE. EVITAR EXPONERSE AL RAYO.
VARO!	• AVATTAESSA OLET ALTTIINA LUOKAN 3B LASERSÄTEILYLLE. ÄLÄ KATSO SÄTEESEEN.
	警告・该产品为3B类激光产品，打开盖子后会有激光辐射， 请避免光束照射。
	警告・該產品為3B類激光產品，打開蓋子後會有激光輻射， 請避免光束照射。
위험	• CLASS 3B 가시 레이저광선을 직접 보지마십시오.
警告	• ここを開くとクラス3Bレーザー光がでます。 ビームを直接見たり、触れないでください。

4. Maintenance

For safety of the service personnel, follow the maintenance instructions in the other section of this manual.

5. Safety switch

The power to the laser unit is cut off when the right cover is opened.

Safety Instructions Regarding the Disconnection of Power

Caution: The power plug is the main isolation device! Other switches on the equipment are only functional switches and are not suitable for isolating the equipment from the power source.

Attention: Le débranchement de la fiche secteur est le seul moyen de mettre l'appareil hors tension. Les interrupteurs sur l'appareil ne sont que des interrupteurs de fonctionnement: ils ne mettent pas l'appareil hors tension.

WARNING

This equipment has been tested and found to comply with the limits for a Class B digital device, pursuant to Part 15 of the FCC Rules. These limits are designed to provide reasonable protection against harmful interference in a residential installation. This equipment generates, uses and can radiate radio frequency energy and, if not installed and used in accordance with the instructions, may cause harmful interference to radio communications. However, there is no guarantee that interference will not occur in a particular installation. If this equipment does cause harmful interference to radio or television reception, which can be determined by turning the equipment off and on, the user is encouraged to try to correct the interference by one or more of the following measures:

- Reorient or relocate the receiving antenna.
- Increase the separation between the equipment and receiver.
- Connect the equipment into an outlet on a circuit different from that to which the receiver is connected.
- Consult the dealer or an experienced radio/TV technician for help.
- The use of a non-shielded interface cable with the referenced device is prohibited.

CAUTION — The changes or modifications not expressly approved by the party responsible for compliance could void the user's authority to operate the equipment.

This device contains the module (FCC ID: E522K3A0512, IC: 1059B-2K3A0512), which complies with Part 15 of FCC Rules and RSS-Gen of IC Rules.

Operation is subject to the following two conditions; (1) this device may not cause interference, and (2) this device must accept any interference, including interference that may cause undesired operation of the device.

Radio Tag Technology

In some countries the radio tag technology used in this equipment to identify the toner container may be subject to authorization and the use of this equipment may consequently be restricted.

Other precautions (for users in California, the United States)

Perchlorate Material - special handling may apply. See www.dtsc.ca.gov/hazardouswaste/perchlorate.

Warranty (the United States and Canada)

3501i / 4501i / 5501i

MULTIFUNCTIONAL PRODUCT LIMITED WARRANTY

KYOCERA Document Solutions America, Inc. and KYOCERA Document Solutions Canada, Ltd. (both referred to as "KYOCERA") warrant the Customer's new Multifunctional Product (referred to as "MFP"), and the new accessories installed with the initial installation of the MFP, against any defects in material and workmanship for a period of one year, or 600,000 copies/prints from date of installation, whichever first occurs. In the event the MFP or an accessory is found to be defective within the warranty period, KYOCERA's only obligation and the Customer's exclusive remedy shall be replacement of any defective parts. KYOCERA shall have no obligation to furnish labor.

This warranty covers Maintenance Kits and the components of Maintenance Kits included with the original MFP for a period of one year or 600,000 copies/prints, whichever first occurs. Maintenance Kits consist of the developing unit, the drum unit, and the fixing unit. Replacement Maintenance Kits have a 90 day Limited Warranty.

This warranty is valid only for the original retail purchaser (referred to as the "Customer") of a new KYOCERA MFP in the United States of America or Canada, based upon the country of purchase.

In order to obtain performance of this warranty, the Customer must immediately notify the Authorized KYOCERA Dealer from whom the product was purchased. If the KYOCERA Dealer is not able to provide service, write to KYOCERA at the address below for the name and address of the Authorized KYOCERA Dealer in your area, or check KYOCERA's website at <http://www.kyoceradocumentsolutions.com>.

This warranty does not cover MFPs or accessories which: (a) have become damaged due to operator negligence, misuse, accidents, improper storage or unusual physical or electrical stress, (b) have used parts or supplies which are not genuine KYOCERA brand parts or supplies, (c) have been installed or serviced by a technician not employed by KYOCERA or an Authorized KYOCERA Dealer, or (d) have had the serial number modified, altered, or removed.

This warranty gives the Customer specific legal rights. The Customer may also have other rights, which vary from state to state, or province to province. Neither the seller, nor any other person, is authorized to extend the time period or expand this warranty on behalf of KYOCERA.

THIS WARRANTY IS MADE IN LIEU OF ALL OTHER WARRANTIES AND CONDITIONS, EXPRESS OR IMPLIED, AND KYOCERA SPECIFICALLY DISCLAIMS ANY IMPLIED WARRANTY OR CONDITION OF MERCHANTABILITY OR FITNESS FOR A PARTICULAR PURPOSE. THIS WARRANTY SHALL NOT EXTEND TO, AND KYOCERA SHALL NOT BE LIABLE FOR, ANY INCIDENTAL OR CONSEQUENTIAL DAMAGES WHICH MAY ARISE OUT OF THE USE OF, OR INABILITY TO USE, THE MFP.

KYOCERA Document Solutions America, Inc.

225 Sand Road,
Fairfield, New Jersey 07004-0008, USA

KYOCERA Document Solutions Canada, Ltd.

6120 Kestrel Rd., Mississauga, ON L5T 1S8,
Canada

Legal Restriction on Copying/Scanning

It may be prohibited to copy/scan copyrighted material without permission of the copyright owner.

Copying/Scanning the following items is prohibited and may be penalized by law. It may not be limited to these items. Do not knowingly copy/scan the items that are not to be copied/scanned.

- Paper money
- Bank note
- Securities
- Stamp
- Passport
- Certificate

Local laws and regulations may prohibit or restrict copying/scanning of other items not mentioned above.

EN ISO 7779

Maschinenlärminformations-Verordnung 3. GPSGV, 06.01.2004: Der höchste Schalldruckpegel beträgt 70 dB (A) oder weniger gemäß EN ISO 7779.

EK1-ITB 2000

Das Gerät ist nicht für die Benutzung im unmittelbaren Gesichtsfeld am Bildschirmarbeitsplatz vorgesehen. Um störende Reflexionen am Bildschirmarbeitsplatz zu vermeiden, darf dieses Produkt nicht im unmittelbaren Gesichtsfeld platziert werden.

Legal Information

Copying or other reproduction of all or part of this guide without the prior written consent of KYOCERA Document Solutions Inc. is prohibited.

Regarding Trade Names

- PRESCRIBE is a registered trademark of Kyocera Corporation.
- KPDL is a trademark of Kyocera Corporation.
- Microsoft, Windows, Windows XP, Windows Server 2003, Windows Vista, Windows Server 2008, Windows 7, Windows Server 2012, Windows 8 and Internet Explorer are registered trademarks or trademarks of Microsoft Corporation in the U.S.A. and/or other countries.
- PCL is a trademark of Hewlett-Packard Company.
- Adobe Acrobat, Adobe Reader and PostScript are trademarks of Adobe Systems, Incorporated.
- Ethernet is a registered trademark of Xerox Corporation.
- IBM and IBM PC/AT are trademarks of International Business Machines Corporation.
- AppleTalk, Bonjour, Macintosh, and Mac OS are trademarks of Apple Inc., registered in the U.S. and other countries.
- Helvetica, Palatino and Times are registered trademarks of Linotype GmbH.
- ITC Avant Garde Gothic, ITC Bookman, ITC ZapfChancery and ITC ZapfDingbats are registered trademarks of International Typeface Corporation.
- UFST™ MicroType® fonts by Monotype Imaging Inc. are installed in this machine.
- This machine contains the software having modules developed by Independent JPEG Group.
- ThinPrint is a trademark of Cortado AG in Germany and other countries.
- This product contains NetFront Browser of ACCESS CO., LTD.
- ACCESS, ACCESS logo and NetFront are trademarks or registered trademarks of ACCESS CO., LTD. in the United States, Japan and other countries.
- © 2011 ACCESS CO., LTD. All rights reserved.
- Java is a registered trademark of Oracle and/or its affiliates.

ACCESS™
NetFront™ Browser



All other brands and product names are registered trademarks or trademarks designations ™ and ® will not be used in this Operation Guide.

GPL/LGPL

This product contains GPL (<http://www.gnu.org/licenses/gpl.html>) and/or LGPL (<http://www.gnu.org/licenses/lgpl.html>) software as part of its firmware. You can get the source code, and you are permitted to copy, redistribute and modify it under the terms of GPL/LGPL. For further information including availability of the source code, visit <http://www.kyoceradocumentsolutions.com/gpl/>.

OpenSSL License

Copyright (c) 1998-2006 The OpenSSL Project. All rights reserved.

Redistribution and use in source and binary forms, with or without modification, are permitted provided that the following conditions are met:

1. Redistributions of source code must retain the above copyright notice, this list of conditions and the following disclaimer.
2. Redistributions in binary form must reproduce the above copyright notice, this list of conditions and the following disclaimer in the documentation and/or other materials provided with the distribution.
3. All advertising materials mentioning features or use of this software must display the following acknowledgment: "This product includes software developed by the OpenSSL Project for use in the OpenSSL Toolkit. (<http://www.openssl.org/>)"
4. The names "OpenSSL Toolkit" and "OpenSSL Project" must not be used to endorse or promote products derived from this software without prior written permission. For written permission, please contact openssl-core@openssl.org.
5. Products derived from this software may not be called "OpenSSL" nor may "OpenSSL" appear in their names without prior written permission of the OpenSSL Project.
6. Redistributions of any form whatsoever must retain the following acknowledgment: "This product includes software developed by the OpenSSL Project for use in the OpenSSL Toolkit (<http://www.openssl.org/>)"

THIS SOFTWARE IS PROVIDED BY THE OpenSSL PROJECT "AS IS" AND ANY EXPRESSED OR IMPLIED WARRANTIES, INCLUDING, BUT NOT LIMITED TO, THE IMPLIED WARRANTIES OF MERCHANTABILITY AND FITNESS FOR A PARTICULAR PURPOSE ARE DISCLAIMED. IN NO EVENT SHALL THE OpenSSL PROJECT OR ITS CONTRIBUTORS BE LIABLE FOR ANY DIRECT, INDIRECT, INCIDENTAL, SPECIAL, EXEMPLARY, OR CONSEQUENTIAL DAMAGES (INCLUDING, BUT NOT LIMITED TO, PROCUREMENT OF SUBSTITUTE GOODS OR SERVICES; LOSS OF USE, DATA, OR PROFITS; OR BUSINESS INTERRUPTION) HOWEVER CAUSED AND ON ANY THEORY OF LIABILITY, WHETHER IN CONTRACT, STRICT LIABILITY, OR TORT (INCLUDING NEGLIGENCE OR OTHERWISE) ARISING IN ANY WAY OUT OF THE USE OF THIS SOFTWARE, EVEN IF ADVISED OF THE POSSIBILITY OF SUCH DAMAGE.

Original SSLeay License

Copyright (C) 1995-1998 Eric Young (eay@cryptsoft.com) All rights reserved.

This package is an SSL implementation written by Eric Young (eay@cryptsoft.com). The implementation was written so as to conform with Netscapes SSL.

This library is free for commercial and non-commercial use as long as the following conditions are adhered to. The following conditions apply to all code found in this distribution, be it the RC4, RSA, lhash, DES, etc., code; not just the SSL code. The SSL documentation included with this distribution is covered by the same copyright terms except that the holder is Tim Hudson (tjh@cryptsoft.com).

Copyright remains Eric Young's, and as such any Copyright notices in the code are not to be removed.

If this package is used in a product, Eric Young should be given attribution as the author of the parts of the library used.

This can be in the form of a textual message at program startup or in documentation (online or textual) provided with the package.

Redistribution and use in source and binary forms, with or without modification, are permitted provided that the following conditions are met:

1. Redistributions of source code must retain the copyright notice, this list of conditions and the following disclaimer.
2. Redistributions in binary form must reproduce the above copyright notice, this list of conditions and the following disclaimer in the documentation and/or other materials provided with the distribution.
3. All advertising materials mentioning features or use of this software must display the following acknowledgement:
"This product includes cryptographic software written by Eric Young (eay@cryptsoft.com)"
The word 'cryptographic' can be left out if the routines from the library being used are not cryptographic related :-).
4. If you include any Windows specific code (or a derivative thereof) from the apps directory (application code) you must include an acknowledgement: "This product includes software written by Tim Hudson (tjh@cryptsoft.com)"

THIS SOFTWARE IS PROVIDED BY ERIC YOUNG "AS IS" AND ANY EXPRESS OR IMPLIED WARRANTIES, INCLUDING, BUT NOT LIMITED TO, THE IMPLIED WARRANTIES OF MERCHANTABILITY AND FITNESS FOR A PARTICULAR PURPOSE ARE DISCLAIMED. IN NO EVENT SHALL THE AUTHOR OR CONTRIBUTORS BE LIABLE FOR ANY DIRECT, INDIRECT, INCIDENTAL, SPECIAL, EXEMPLARY, OR CONSEQUENTIAL DAMAGES (INCLUDING, BUT NOT LIMITED TO, PROCUREMENT OF SUBSTITUTE GOODS OR SERVICES; LOSS OF USE, DATA, OR PROFITS; OR BUSINESS INTERRUPTION) HOWEVER CAUSED AND ON ANY THEORY OF LIABILITY, WHETHER IN CONTRACT, STRICT LIABILITY, OR TORT (INCLUDING NEGLIGENCE OR OTHERWISE) ARISING IN ANY WAY OUT OF THE USE OF THIS SOFTWARE, EVEN IF ADVISED OF THE POSSIBILITY OF SUCH DAMAGE.

The licence and distribution terms for any publically available version or derivative of this code cannot be changed. i.e. this code cannot simply be copied and put under another distribution licence [including the GNU Public Licence.]

Monotype Imaging License Agreement

- 1 *Software* shall mean the digitally encoded, machine readable, scalable outline data as encoded in a special format as well as the UFST Software.
- 2 You agree to accept a non-exclusive license to use the Software to reproduce and display weights, styles and versions of letters, numerals, characters and symbols (*Typefaces*) solely for your own customary business or personal purposes at the address stated on the registration card you return to Monotype Imaging. Under the terms of this License Agreement, you have the right to use the Fonts on up to three printers. If you need to have access to the fonts on more than three printers, you need to acquire a multiuser license agreement which can be obtained from Monotype Imaging. Monotype Imaging retains all rights, title and interest to the Software and Typefaces and no rights are granted to you other than a License to use the Software on the terms expressly set forth in this Agreement.
- 3 To protect proprietary rights of Monotype Imaging, you agree to maintain the Software and other proprietary information concerning the Typefaces in strict confidence and to establish reasonable procedures regulating access to and use of the Software and Typefaces.
- 4 You agree not to duplicate or copy the Software or Typefaces, except that you may make one backup copy. You agree that any such copy shall contain the same proprietary notices as those appearing on the original.
- 5 This License shall continue until the last use of the Software and Typefaces, unless sooner terminated. This License may be terminated by Monotype Imaging if you fail to comply with the terms of this License and such failure is not remedied within thirty (30) days after notice from Monotype Imaging. When this License expires or is terminated, you shall either return to Monotype Imaging or destroy all copies of the Software and Typefaces and documentation as requested.
- 6 You agree that you will not modify, alter, disassemble, decrypt, reverse engineer or decompile the Software.
- 7 Monotype Imaging warrants that for ninety (90) days after delivery, the Software will perform in accordance with Monotype Imaging-published specifications, and the diskette will be free from defects in material and workmanship. Monotype Imaging does not warrant that the Software is free from all bugs, errors and omissions.

The parties agree that all other warranties, expressed or implied, including warranties of fitness for a particular purpose and merchantability, are excluded.
- 8 Your exclusive remedy and the sole liability of Monotype Imaging in connection with the Software and Typefaces is repair or replacement of defective parts, upon their return to Monotype Imaging.

In no event will Monotype Imaging be liable for lost profits, lost data, or any other incidental or consequential damages, or any damages caused by abuse or misapplication of the Software and Typefaces.
- 9 Massachusetts U.S.A. law governs this Agreement.

- 10 You shall not sublicense, sell, lease, or otherwise transfer the Software and/or Typefaces without the prior written consent of Monotype Imaging.
- 11 Use, duplication or disclosure by the Government is subject to restrictions as set forth in the Rights in Technical Data and Computer Software clause at FAR 252-227-7013, subdivision (b)(3)(ii) or subparagraph (c)(1)(ii), as appropriate. Further use, duplication or disclosure is subject to restrictions applicable to restricted rights software as set forth in FAR 52.227-19 (c)(2).
- 12 You acknowledge that you have read this Agreement, understand it, and agree to be bound by its terms and conditions. Neither party shall be bound by any statement or representation not contained in this Agreement. No change in this Agreement is effective unless written and signed by properly authorized representatives of each party. By opening this diskette package, you agree to accept the terms and conditions of this Agreement.

Knopflerfish License

This product includes software developed by the Knopflerfish Project.

<http://www.knopflerfish.org>

Copyright 2003-2010 The Knopflerfish Project. All rights reserved.

Redistribution and use in source and binary forms, with or without modification, are permitted provided that the following conditions are met:

- Redistributions of source code must retain the above copyright notice, this list of conditions and the following disclaimer.
- Redistributions in binary form must reproduce the above copyright notice, this list of conditions and the following disclaimer in the documentation and/or other materials provided with the distribution.
- Neither the name of the KNOPFLERFISH project nor the names of its contributors may be used to endorse or promote products derived from this software without specific prior written permission.

THIS SOFTWARE IS PROVIDED BY THE COPYRIGHT HOLDERS AND CONTRIBUTORS "AS IS" AND ANY EXPRESS OR IMPLIED WARRANTIES, INCLUDING, BUT NOT LIMITED TO, THE IMPLIED WARRANTIES OF MERCHANTABILITY AND FITNESS FOR A PARTICULAR PURPOSE ARE DISCLAIMED. IN NO EVENT SHALL THE COPYRIGHT OWNER OR CONTRIBUTORS BE LIABLE FOR ANY DIRECT, INDIRECT, INCIDENTAL, SPECIAL, EXEMPLARY, OR CONSEQUENTIAL DAMAGES (INCLUDING, BUT NOT LIMITED TO, PROCUREMENT OF SUBSTITUTE GOODS OR SERVICES; LOSS OF USE, DATA, OR PROFITS; OR BUSINESS INTERRUPTION) HOWEVER CAUSED AND ON ANY THEORY OF LIABILITY, WHETHER IN CONTRACT, STRICT LIABILITY, OR TORT (INCLUDING NEGLIGENCE OR OTHERWISE) ARISING IN ANY WAY OUT OF THE USE OF THIS SOFTWARE, EVEN IF ADVISED OF THE POSSIBILITY OF SUCH DAMAGE.

Apache License (Version 2.0)

Apache License
Version 2.0, January 2004
<http://www.apache.org/licenses/>

TERMS AND CONDITIONS FOR USE, REPRODUCTION, AND DISTRIBUTION

1. Definitions.

"License" shall mean the terms and conditions for use, reproduction, and distribution as defined by Sections 1 through 9 of this document.

"Licensor" shall mean the copyright owner or entity authorized by the copyright owner that is granting the License.

"Legal Entity" shall mean the union of the acting entity and all other entities that control, are controlled by, or are under common control with that entity. For the purposes of this definition, "control" means (i) the power, direct or indirect, to cause the direction or management of such entity, whether by contract or otherwise, or (ii) ownership of fifty percent (50%) or more of the outstanding shares, or (iii) beneficial ownership of such entity.

"You" (or "Your") shall mean an individual or Legal Entity exercising permissions granted by this License.

"Source" form shall mean the preferred form for making modifications, including but not limited to software source code, documentation source, and configuration files.

"Object" form shall mean any form resulting from mechanical transformation or translation of a Source form, including but not limited to compiled object code, generated documentation, and conversions to other media types.

"Work" shall mean the work of authorship, whether in Source or Object form, made available under the License, as indicated by a copyright notice that is included in or attached to the work (an example is provided in the Appendix below).

"Derivative Works" shall mean any work, whether in Source or Object form, that is based on (or derived from) the Work and for which the editorial revisions, annotations, elaborations, or other modifications represent, as a whole, an original work of authorship. For the purposes of this License, Derivative Works shall not include works that remain separable from, or merely link (or bind by name) to the interfaces of, the Work and Derivative Works thereof.

"Contribution" shall mean any work of authorship, including the original version of the Work and any modifications or additions to that Work or Derivative Works thereof, that is intentionally submitted to Licensor for inclusion in the Work by the copyright owner or by an individual or Legal Entity authorized to submit on behalf of the copyright owner. For the purposes of this definition, "submitted" means any form of electronic, verbal, or written communication sent to the Licensor or its representatives, including but not limited to communication on electronic mailing lists, source code control systems, and issue tracking systems that are managed by, or on behalf of, the Licensor for the purpose of discussing and improving the Work, but excluding communication that is conspicuously marked or otherwise designated in writing by the copyright owner as "Not a Contribution."

"Contributor" shall mean Licensor and any individual or Legal Entity on behalf of whom a Contribution has been received by Licensor and subsequently incorporated within the Work.

2. Grant of Copyright License. Subject to the terms and conditions of this License, each Contributor hereby grants to You a perpetual, worldwide, non-exclusive, no-charge, royalty-free, irrevocable copyright license to reproduce, prepare Derivative Works of, publicly display, publicly perform, sublicense, and distribute the Work and such Derivative Works in Source or Object form.
3. Grant of Patent License. Subject to the terms and conditions of this License, each Contributor hereby grants to You a perpetual, worldwide, non-exclusive, no-charge, royalty-free, irrevocable (except as stated in this section) patent license to make, have made, use, offer to sell, sell, import, and otherwise transfer the Work, where such license applies only to those patent claims licensable by such Contributor that are necessarily infringed by their Contribution(s) alone or by combination of their Contribution(s) with the Work to which such Contribution(s) was submitted. If You institute patent litigation against any entity (including a cross-claim or counterclaim in a lawsuit) alleging that the Work or a Contribution incorporated within the Work constitutes direct or contributory patent infringement, then any patent licenses granted to You under this License for that Work shall terminate as of the date such litigation is filed.
4. Redistribution. You may reproduce and distribute copies of the Work or Derivative Works thereof in any medium, with or without modifications, and in Source or Object form, provided that You meet the following conditions:
 - (a) You must give any other recipients of the Work or Derivative Works a copy of this License; and
 - (b) You must cause any modified files to carry prominent notices stating that You changed the files; and
 - (c) You must retain, in the Source form of any Derivative Works that You distribute, all copyright, patent, trademark, and attribution notices from the Source form of the Work, excluding those notices that do not pertain to any part of the Derivative Works; and
 - (d) If the Work includes a "NOTICE" text file as part of its distribution, then any Derivative Works that You distribute must include a readable copy of the attribution notices contained within such NOTICE file, excluding those notices that do not pertain to any part of the Derivative Works, in at least one of the following places: within a NOTICE text file distributed as part of the Derivative Works; within the Source form or documentation, if provided along with the Derivative Works; or, within a display generated by the Derivative Works, if and wherever such third-party notices normally appear. The contents of the NOTICE file are for informational purposes only and do not modify the License. You may add Your own attribution notices within Derivative Works that You distribute, alongside or as an addendum to the NOTICE text from the Work, provided that such additional attribution notices cannot be construed as modifying the License.

You may add Your own copyright statement to Your modifications and may provide additional or different license terms and conditions for use, reproduction, or distribution of Your modifications, or for any such Derivative Works as a whole, provided Your use, reproduction, and distribution of the Work otherwise complies with the conditions stated in this License.

5. **Submission of Contributions.** Unless You explicitly state otherwise, any Contribution intentionally submitted for inclusion in the Work by You to the Licensor shall be under the terms and conditions of this License, without any additional terms or conditions. Notwithstanding the above, nothing herein shall supersede or modify the terms of any separate license agreement you may have executed with Licensor regarding such Contributions.
6. **Trademarks.** This License does not grant permission to use the trade names, trademarks, service marks, or product names of the Licensor, except as required for reasonable and customary use in describing the origin of the Work and reproducing the content of the NOTICE file.
7. **Disclaimer of Warranty.** Unless required by applicable law or agreed to in writing, Licensor provides the Work (and each Contributor provides its Contributions) on an "AS IS" BASIS, WITHOUT WARRANTIES OR CONDITIONS OF ANY KIND, either express or implied, including, without limitation, any warranties or conditions of TITLE, NON-INFRINGEMENT, MERCHANTABILITY, or FITNESS FOR A PARTICULAR PURPOSE. You are solely responsible for determining the appropriateness of using or redistributing the Work and assume any risks associated with Your exercise of permissions under this License.
8. **Limitation of Liability.** In no event and under no legal theory, whether in tort (including negligence), contract, or otherwise, unless required by applicable law (such as deliberate and grossly negligent acts) or agreed to in writing, shall any Contributor be liable to You for damages, including any direct, indirect, special, incidental, or consequential damages of any character arising as a result of this License or out of the use or inability to use the Work (including but not limited to damages for loss of goodwill, work stoppage, computer failure or malfunction, or any and all other commercial damages or losses), even if such Contributor has been advised of the possibility of such damages.
9. **Accepting Warranty or Additional Liability.** While redistributing the Work or Derivative Works thereof, You may choose to offer, and charge a fee for, acceptance of support, warranty, indemnity, or other liability obligations and/or rights consistent with this License. However, in accepting such obligations, You may act only on Your own behalf and on Your sole responsibility, not on behalf of any other Contributor, and only if You agree to indemnify, defend, and hold each Contributor harmless for any liability incurred by, or claims asserted against, such Contributor by reason of your accepting any such warranty or additional liability.

END OF TERMS AND CONDITIONS

APPENDIX: How to apply the Apache License to your work.

To apply the Apache License to your work, attach the following boilerplate notice, with the fields enclosed by brackets "[]" replaced with your own identifying information. (Don't include the brackets!) The text should be enclosed in the appropriate comment syntax for the file format. We also recommend that a file or class name and description of purpose be included on the same "printed page" as the copyright notice for easier identification within third-party archives.

Copyright [yyyy] [name of copyright owner]

Licensed under the Apache License, Version 2.0 (the "License"); you may not use this file except in compliance with the License. You may obtain a copy of the License at

<http://www.apache.org/licenses/LICENSE-2.0>

Unless required by applicable law or agreed to in writing, software distributed under the License is distributed on an "AS IS" BASIS, WITHOUT WARRANTIES OR CONDITIONS OF ANY KIND, either express or implied. See the License for the specific language governing permissions and limitations under the License.

Energy Saving Control Function

The device comes equipped with a **Low Power Mode** where energy consumption is reduced after a certain amount of time elapses since the device was last used, as well as a **Sleep** where printer and fax functions remain in a waiting state but power consumption is still reduced to a minimum when there is no activity with the device within a set amount of time.

Low Power Mode

The device automatically enters Low Power Mode when 2 minutes have passed since the device was last used. The amount of time of no activity that must pass before Low Power Mode is activated may be lengthened. For more information refer to [Low Power Mode and Auto Low Power Mode \(page 3-14\)](#).

Sleep

The device automatically enters Sleep when 45 minutes (for 3501i), or 60 minutes (for 4501i or 5501i) have passed since the device was last used. The amount of time of no activity that must pass before Sleep is activated may be lengthened. For more information see [Sleep and Auto Sleep \(page 3-15\)](#).

Automatic 2-Sided Copy Function

This device includes 2-sided copying as a standard function. For example, by copying two 1-sided originals onto a single sheet of paper as a 2-sided copy, it is possible to lower the amount of paper used. For more information refer to [Duplex \(page 6-38\)](#).

Printing in duplex mode reduces paper consumption and contributes to the conservation of forest resources. Duplex mode also reduces the amount of paper that must be purchased, and thereby reduces cost. It is recommended that machines capable of duplex printing be set to use duplex mode by default.

Resource Saving - Paper

For the preservation and sustainable use of forest resources, it is recommended that recycled as well as virgin paper certified under environmental stewardship initiatives or carrying recognised ecolabels, which meet EN 12281:2002* or an equivalent quality standard, be used.

This machine also supports printing on 64 g/m² paper. Using such paper containing less raw materials can lead to further saving of forest resources.

* : EN12281:2002 "Printing and business paper - Requirements for copy paper for dry toner imaging processes"

Your sales or service representative can provide information about recommended paper types.

Environmental benefits of "Power Management"

To reduce power consumption when idle, this machine is equipped with a power management function that automatically activates energy-saving mode when the machine is idle for a certain period of time.

Although it takes the machine a slight amount of time to return to READY mode when in energy-saving mode, a significant reduction in energy consumption is possible. It is recommended that the machine be used with the activation time for energy-saving mode set to the default setting.

Energy Star (ENERGY STAR®) Program



We have determined as a participating company in the International Energy Star Program that this product is compliant with the standards laid out in the International Energy Star Program.

ENERGY STAR® is a voluntary energy efficiency program with the goal of developing and promoting the use of products with high energy efficiency in order to help prevent global warming. By purchasing

ENERGY STAR® qualified products, customers can help reduce emissions of greenhouse gases during product use and cut energy-related costs.

2 Installing and Setting up the Machine

This chapter provides information for the administrator of this machine, such as part names, cable connection, and software installation.

Part Names	2-2
Machine Exterior	2-2
Connectors/Interior	2-4
With Optional Equipments Attached	2-5
Determining the Connection Method and Preparing Cables	2-6
Connection Example	2-6
Preparing Necessary Cables	2-7
Connecting Cables	2-8
Connecting LAN Cable	2-8
Connecting USB Cable	2-9
Connecting the Power Cable	2-9
Power On/Off	2-10
Power On	2-10
Power Off	2-11
Installing Software	2-13
Software on DVD (Windows)	2-13
Installing Printer Driver in Windows	2-14
Uninstalling the Software	2-16
Installing Printer Driver in Macintosh	2-17
Setting TWAIN Driver	2-19
Setting WIA Driver	2-20
Login/Logout	2-21
Login	2-21
Logout	2-22
Default Settings of the Machine	2-23
Setting Date and Time	2-23
Network Setup (LAN Cable Connection)	2-25
Quick Setup Wizard	2-28
Checking the Counter	2-30
Additional Preparations for the Administrator	2-31
To Send Documents to a PC	2-31
To E-mail Scanned Images	2-31
To Strengthen the Security	2-31
Command Center RX	2-33
Accessing Command Center RX	2-34
Changing Security Settings	2-35
Changing Device Information	2-36
E-mail settings	2-37
Registering Destinations	2-40
Registering a Custom Box	2-41
Printing a document stored in a Custom Box	2-42
Transferring data from our other products	2-44
Migrating the Address Book	2-44

Part Names

Machine Exterior

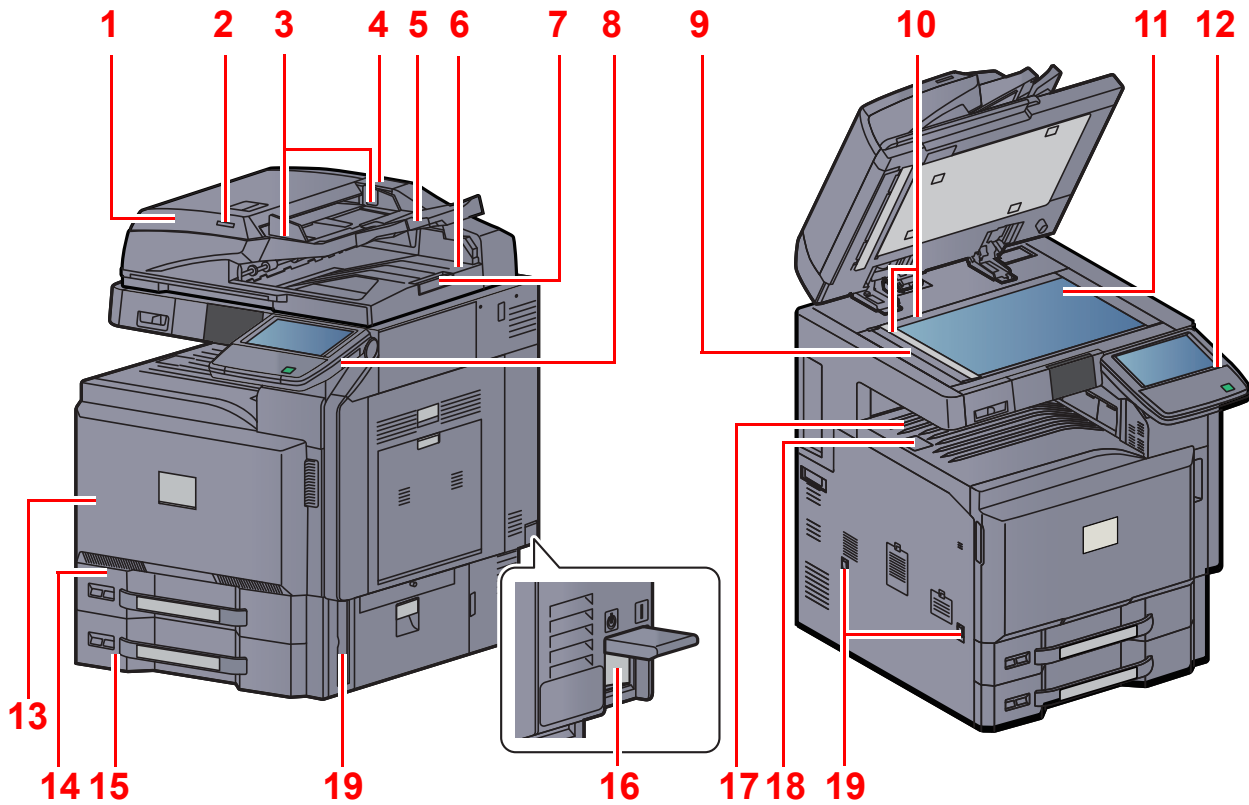

- | | |
|-----------------------------------|----------------------|
| 1 Document Processor (Option) | 11 Platen |
| 2 Original Loaded Indicator | 12 Operation Panel |
| 3 Original Width Guides | 13 Front Cover |
| 4 Cleaning Cloth Compartment | 14 Cassette 1 |
| 5 Original Table | 15 Cassette 2 |
| 6 Original eject table | 16 Main Power Switch |
| 7 Original stopper | 17 Inner Tray |
| 8 USB Port (A1) | 18 Paper stopper |
| 9 Slit Glass | 19 Handles |
| 10 Original Size Indicator Plates | |

 [Optional Equipment \(page 11-2\)](#)

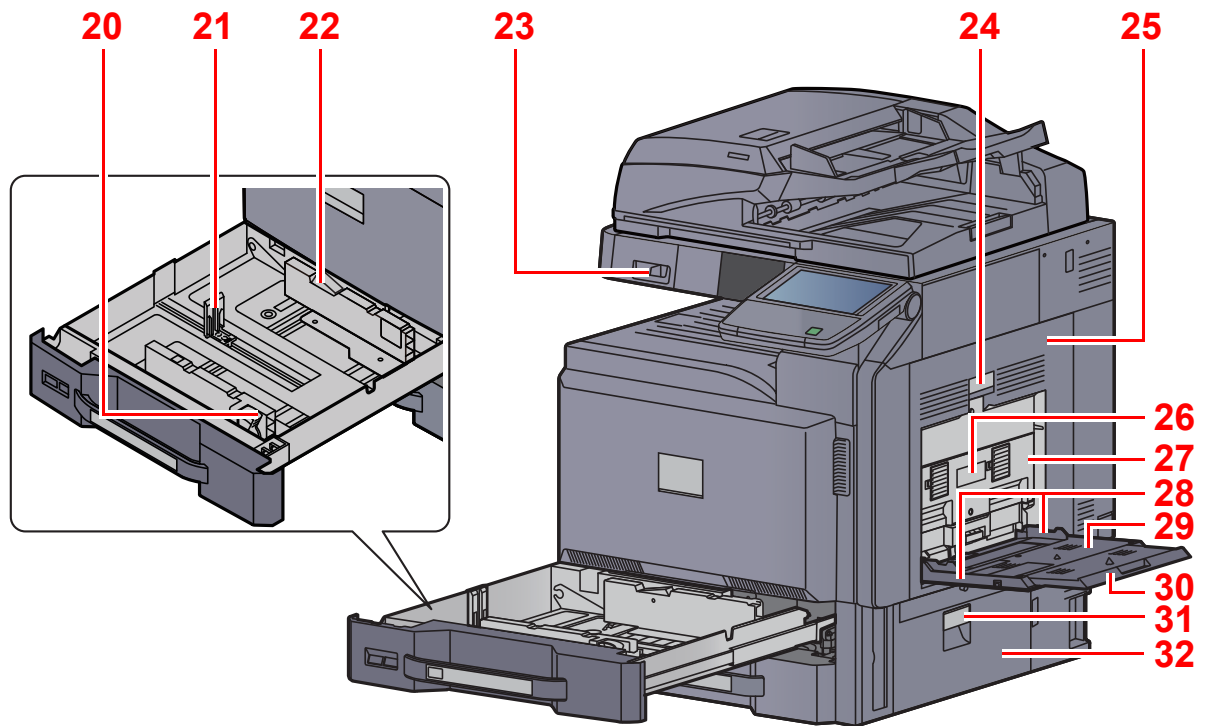

- 20 Paper Width Adjusting Tab
- 21 Paper Length Guide
- 22 (Paper Width Guide) Lock
- 23 Clip Holder
- 24 Right Cover 1 Lever
- 25 Right Cover 1
- 26 Right Cover 2 Lever
- 27 Right Cover 2
- 28 Paper Width Guide
- 29 Multi Purpose Tray
- 30 Support Tray Section of the Multi Purpose Tray
- 31 Right Cover 3 Lever
- 32 Right Cover 3

Connectors/Interior

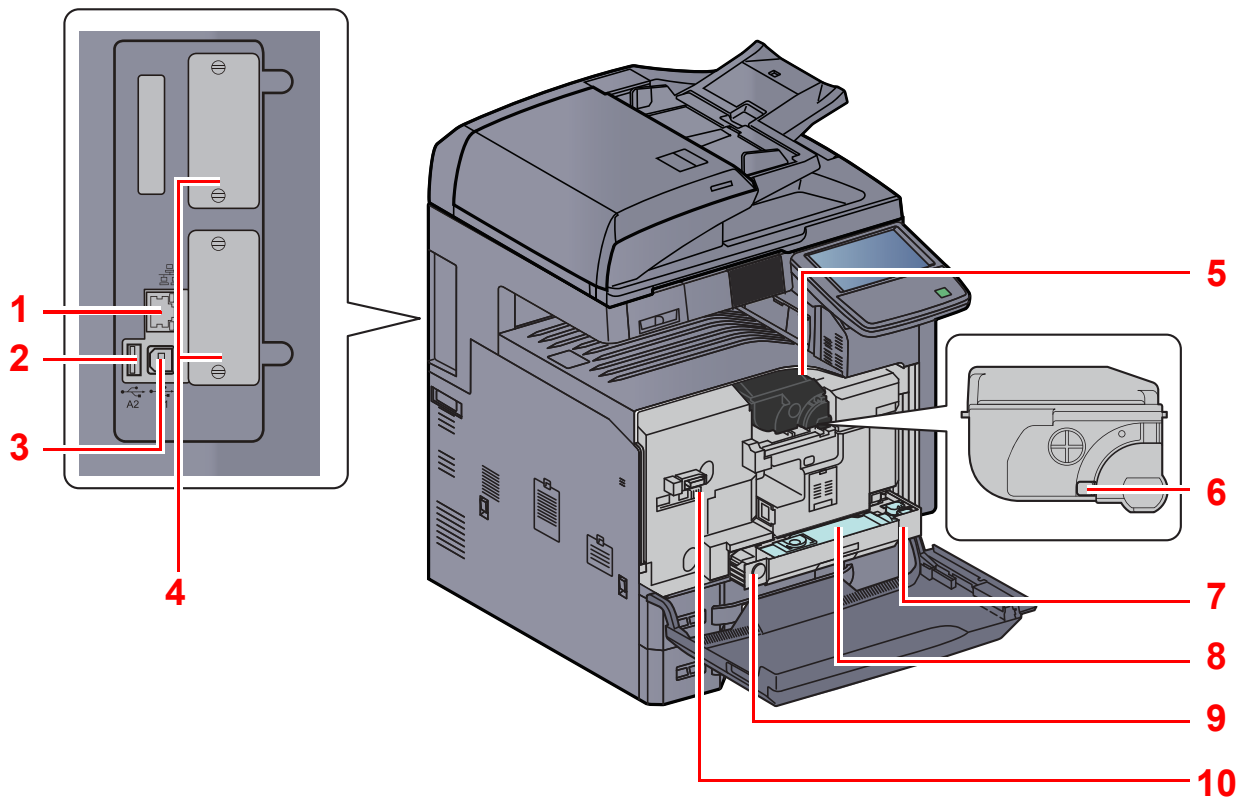

- 1 Network Interface Connector
- 2 USB Port (A2)
- 3 USB Interface Connector (B1)
- 4 Option Interface
- 5 Toner Container (Black)
- 6 Toner Container Release Lever
- 7 Waste Toner Tray
- 8 Waste Toner Box
- 9 Release Button
- 10 Cleaning Brush

With Optional Equipments Attached

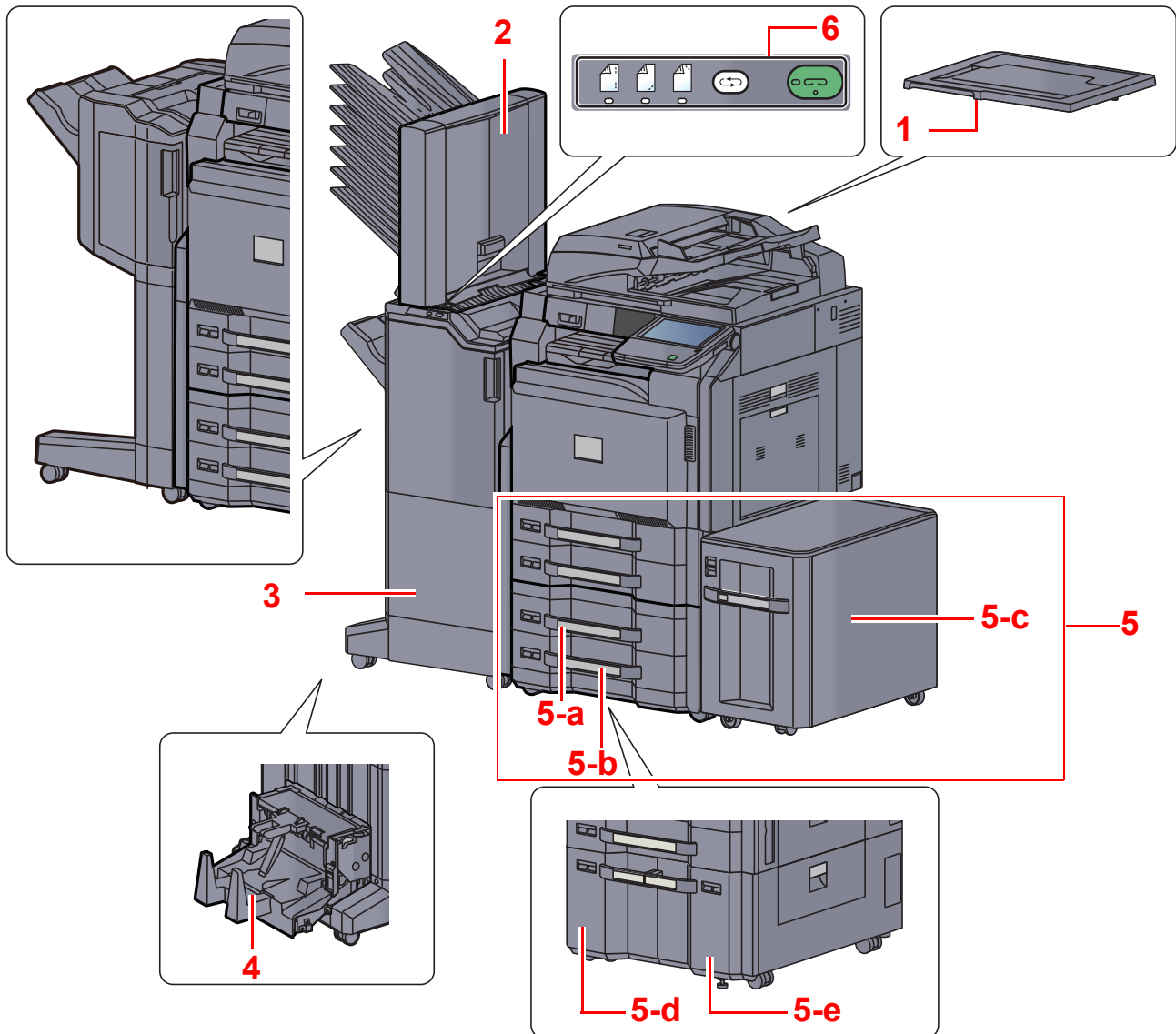

- 1 Platen Cover
- 2 Mailbox
- 3 Document Finisher
- 4 Folding Unit
- 5 Cassette 3 to 5
 - 5-a: Cassette 3 • 5-b: Cassette 4 • 5-c: Cassette 5
 - 5-d: Cassette 4 • 5-e: Cassette 3

 [Optional Equipment \(page 11-2\)](#)

6 Control Section of the Finisher

 [Manual Staple \(page 5-73\)](#)

Determining the Connection Method and Preparing Cables

Check the method to connect the equipment to a PC or network, and prepare the necessary cables for your environment.

Connection Example

Determine the method to connect the equipment to a PC or network by referring to the illustration below.

Connecting a scanner to your PC network with a network cable (1000BASE-T, 100BASE-TX or 10BASE-T)

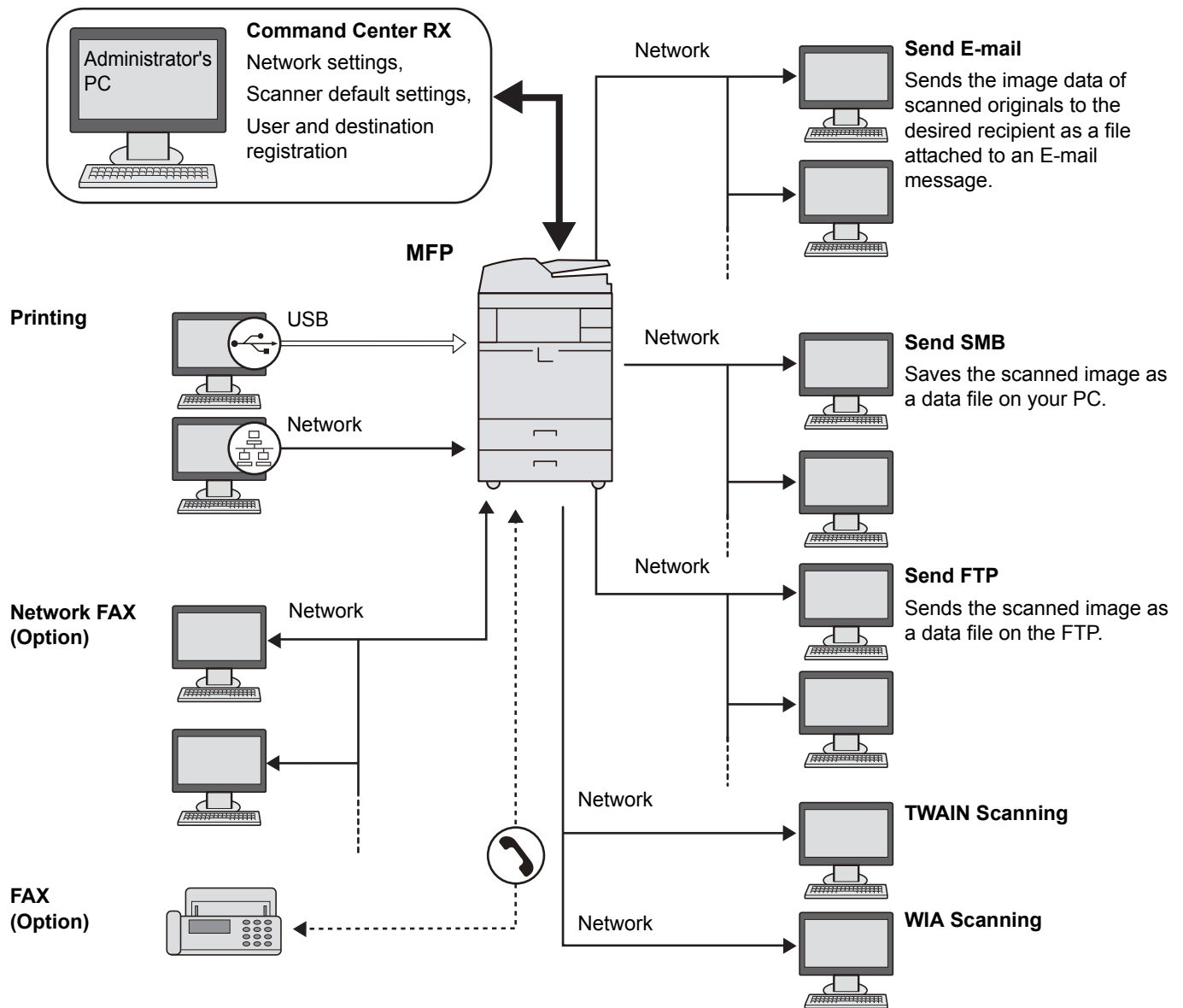

TWAIN and WIA are standardized interface for communication between software applications and image acquisition devices.

NOTE

If you are using the machine with the optional wireless interface kit attached, you do not need to connect the LAN cable.

[Optional Network \(page 8-47\)](#)

Preparing Necessary Cables

Prepare the necessary cables according to the interface you use.

Available Standard Interfaces

Connection Environment	Function	Necessary Cable
Connect a LAN cable to the machine.	Printer/Scanner /Network FAX*	Network Interface LAN (10BASE-T or 100BASE-TX, 1000BASE-T Shielded)
Connect a USB cable to the machine.	Printer	USB2.0 compatible cable (Hi-Speed USB compliant, Max. 5.0 m, Shielded)

* Function available when using optional FAX Kit. For more information on using the Network FAX, refer to the **FAX Operation Guide**.

Connecting Cables

Connecting LAN Cable

✔ **IMPORTANT**

If the power is on, turn the main power switch off.

🔍 [Power Off \(page 2-11\)](#)

1 Connect the machine.

- 1 Connect the LAN cable to the network interface connector.

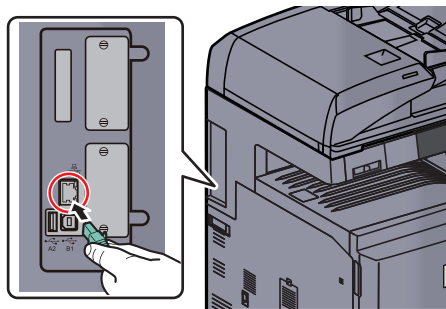

- 2 Connect the other end of the cable to the hub.

2 Set up the machine.

Power on the machine and configure the network.

🔍 For details, refer to [Network Setup \(LAN Cable Connection\) on page 2-25](#).

Connecting USB Cable

✔ **IMPORTANT**

If the power is on, turn the main power switch off.

🔍 [Power Off \(page 2-11\)](#)

1 Connect the machine.

- 1 Connect the USB cable to the USB interface connector (B1) located on the left side of the body.

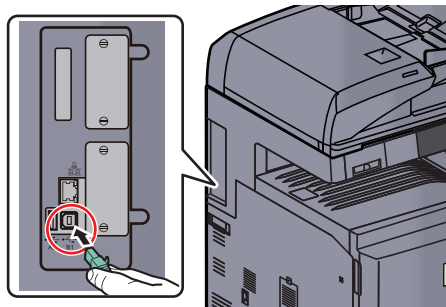

- 2 Connect the other end of the cable to the PC.

Connecting the Power Cable

Connect one end of the supplied power cable to the machine and the other end to a power outlet.

✔ **IMPORTANT**

Only use the power cable that comes with the machine.

Power On/Off

Power On

When the main power indicator is lit... (Recovery from sleep)

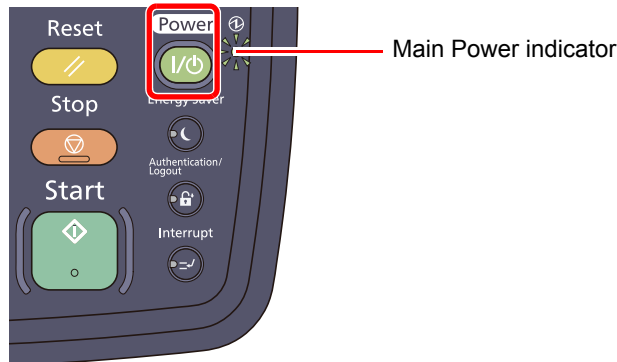

Press the [Power] key.

When the main power indicator is off...

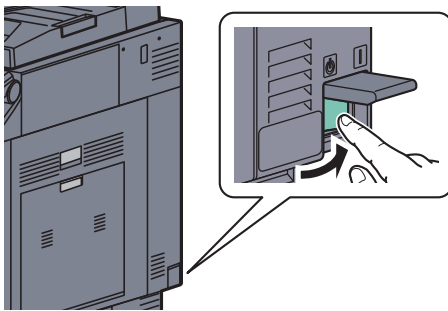

Turn the main power switch on.

 **IMPORTANT**

When turning off the main power switch, do not turn on the main power switch again immediately. Wait more than 5 seconds, and then turn on the main power switch.

 **NOTE**

If the optional Data Security Kit is activated, a message might display indicating the security function is being activated and time may take some time to start up when the power is turned on.

Power Off

When not turning off the main power switch... (sleep)

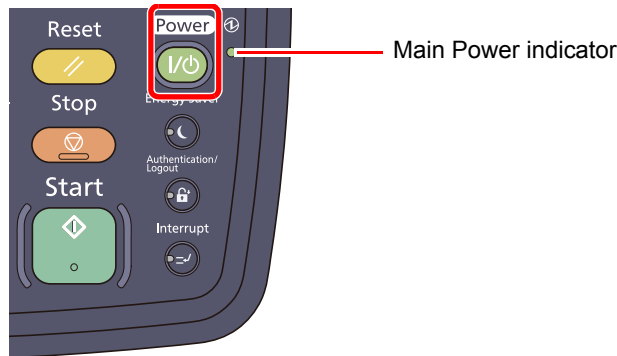

Press the [Power] key. The [Power] key light will go out, and the Main Power indicator will light up.

 [Low Power Mode and Auto Low Power Mode \(page 3-14\)](#)
[Sleep and Auto Sleep \(page 3-15\)](#)

When turning off the main power switch...

Note that when the main power switch is turned off, the machine will be unable to automatically receive print data from computers or faxes.

IMPORTANT

When the [Processing] indicator or [Memory] indicator is lit up or blinked, the machine is operating. Turning off the main power switch while the machine is operating may cause it to malfunction.

1 Press the [Power] key.

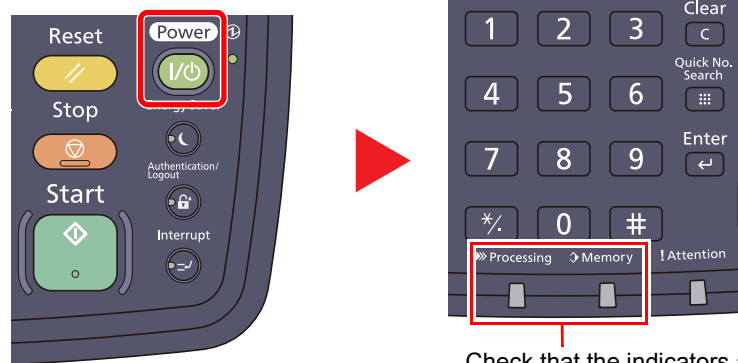

Verify that the [Power] key light has gone out and that the Main Power indicator is lit up.

2 Turn the main power switch off.

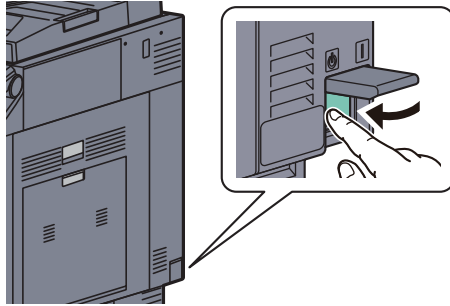

In case of not using the machine for an extended period of time...



CAUTION

If this machine will be left unused for an extended period (e.g. overnight), turn it off at the main power switch. If the machine will not be used for an even longer period of time (e.g. vacation), remove the power plug from the outlet as a safety precaution. If the optional FAX Kit is installed, note that turning the machine off at the main power switch disables fax transmission and reception.



IMPORTANT

Remove paper from the cassettes and seal it in the paper storage bag to protect it from humidity.

Installing Software

Install appropriate software on your PC from the included DVD (Product Library) if you want to use the printer function of this machine or perform TWAIN / WIA transmission or Network FAX transmission from your PC.

Software on DVD (Windows)

You can use either [[Express Install](#)] or [[Custom Install](#)] can be selected for the installation method. The software that can be installed and the printer port selection method vary depending on which method is selected.

Software	Function	Description	Installation method	
			Express Install	Custom Install
KX DRIVER	Print	This driver enables files on a computer to be printed by the machine. Multiple page description languages (PCL XL, KPDL, etc.) are supported by a single driver. This printer driver allows you to take full advantage of the features of the machine. Use this driver to print PDF files.	●	○
KX XPS DRIVER		This printer driver supports the XPS (XML Paper Specification) format developed by Microsoft Corporation.	-	○
KPDL mini-driver/ PCL mini-driver		This is a Microsoft MiniDriver that supports PCL and KPDL. There are some restrictions on the machine features and option features that can be used with this driver.	-	○
Kyocera TWAIN Driver	Scan	This driver enables scanning on the machine using a TWAIN-compliant software application. The machine has two types of TWAIN drivers: one for scanning a document placed in the machine, and one for reading document data stored in a custom box.	●	○
Kyocera WIA Driver		WIA (Windows Imaging Acquisition) is a function of Windows that enables reciprocal communication between an imaging device such as a scanner and an image processing software application. An image can be acquired using a WIA-compliant software application, which is convenient when a TWAIN-compliant software application is not installed in the computer.	-	○
FAX Driver	FAX	This makes it possible to send a document created in a computer software application as a fax via the machine.	-	○
File Management Utility	Utility	This makes it possible to send and save a scanned document to a specified network folder.	-	○
KYOCERA Net Direct Print		This makes it possible to print a PDF file without starting Adobe Acrobat/Reader.	-	○
KYOCERA Net Viewer		This is a utility for administrators that enables monitoring of the machine on the network.	-	○
FONTS	-	These are display fonts that enable the machine's built-in fonts to be used in a software application.	●	○

 **NOTE**

Installation on Windows must be done by a user logged on with administrator privileges.

When connected by USB cable, Plug and Play is disabled on this device when in Sleep mode. To continue the installation, press the [Power] key to wake the device from Low Power Mode or Sleep before continuing.

The optional FAX Kit is required in order to make use of fax functionality.

WIA driver and KX XPS DRIVER cannot be installed on Windows XP.

Installing Printer Driver in Windows

The following procedure is an example for installing the software in Windows 7 using [Express Install].

You can use either [Express Install] or [Custom Install] can be selected for the installation method. [Express Install] automatically detects connected machines and installs the required software. Use [Custom Install] if you want to specify the printer port and select the software to be installed. For details, refer to Custom Installation in the **Printer Driver User Guide** on the DVD.

1 Insert the DVD.

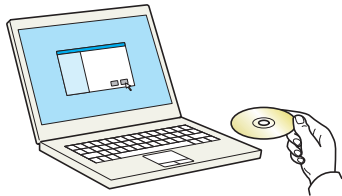

 **NOTE**

Installation on Windows must be done by a user logged on with administrator privileges.

If the "**Welcome to the Found New Hardware Wizard**" dialog box displays, select [Cancel].

If the autorun screen is displayed, click [Run Setup.exe].

If the user account management window appears, click [Yes] ([Allow]).

2 Display the screen.

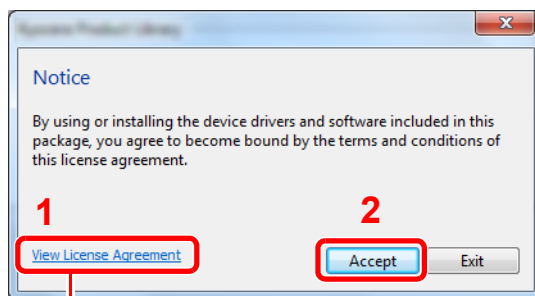

Click [View License Agreement] and read the License Agreement.

3 Install using [Express Install].

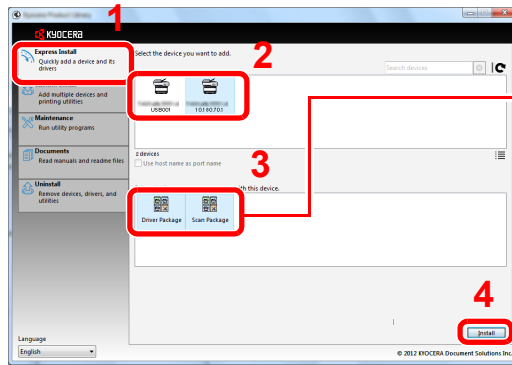

Packages include the following software:

- Driver Package
KX DRIVER, Fonts
- Scan Package
Kyocera TWAIN Driver

You can also select [Use host name for port name] and set to use the host name of the standard TCP/IP port. (A USB connection cannot be used.)



NOTE

The machine cannot be detected unless it is on. If the computer fails to detect the machine, verify that it is connected to the computer via a network or USB cable and that it is turned on and click  (Reload).

If the Windows security window appears, click [[Install this driver software anyway](#)].

4 Finish the installation.

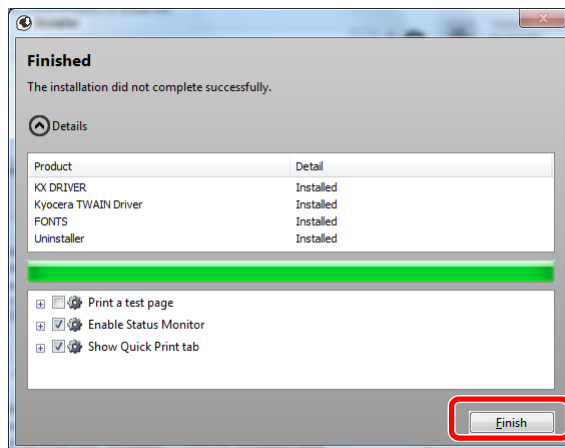

NOTE

When you have selected [[Device settings](#)] in Windows XP, the dialog box for device setting will appear after [[Finish](#)] is clicked. Configure the settings for options installed on the machine. Device settings can be configured after the installation is completed. For details, refer to the Device Settings in the **Printer Driver User Guide** on the DVD.

If a system restart message appears, restart the computer by following the screen prompts. This completes the printer driver installation procedure.

The TWAIN driver can be installed if the machine and computer are connected via a network. If you are installing the TWAIN driver, continue by configuring the [Setting TWAIN Driver \(page 2-19\)](#).

Uninstalling the Software

Perform the following procedure to delete the Software from your computer.



NOTE

Uninstallation on Windows must be done by a user logged on with administrator privileges.

1 Display the screen.

Click **[Start]** button on the Windows and then select **[All Programs]**, **[Kyocera]**, and **[Uninstall Kyocera Product Library]** to display the Uninstall Wizard.

2 Uninstall the software.

Place a check in the check box of the software to be deleted.

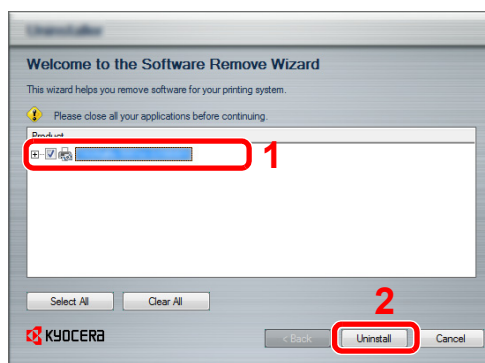

3 Finish uninstalling.

If a system restart message appears, restart the computer by following the screen prompts. This completes the software uninstallation procedure.



NOTE

The software can also be uninstalled using the Product Library.

In the Product Library installation screen, click **[Uninstall]**, and follow the on-screen instructions to uninstall the software.

Installing Printer Driver in Macintosh

The machine's printer functionality can be used by a Macintosh computer.

NOTE

Installation on MAC OS must be done by a user logged on with administrator privileges.

When printing from a Macintosh computer, set the machine's emulation to [KPD(L)] or [KPD(L)(Auto)].

 For details, refer to [Printer on page 8-35](#).

If connecting by Bonjour, enable Bonjour in the machine's network settings.

 For details, refer to [Bonjour Settings on page 2-27](#).

In the Authenticate screen, enter the name and password used to log in to the operating system.

1 Insert the DVD.

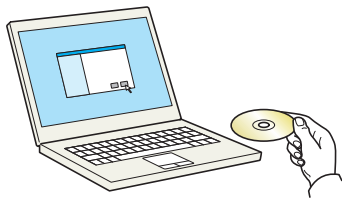

Double-click the [[Kyocera](#)] icon.

2 Display the screen.

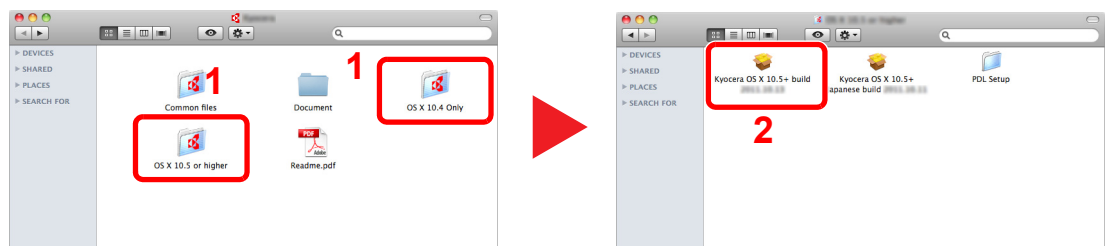

Double-click [[Kyocera OS X vx.x](#)] depending on your Mac OS version.

3 Install the Printer Driver.

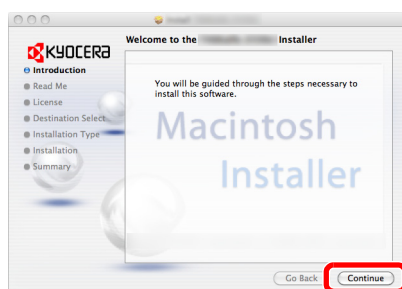

Install the printer driver as directed by the instructions in the installation software.

This completes the printer driver installation.

If a USB connection is used, the machine is automatically recognized and connected.
If an IP connection is used, the settings below are required.

4 Configure the printer.

1 Display the window.

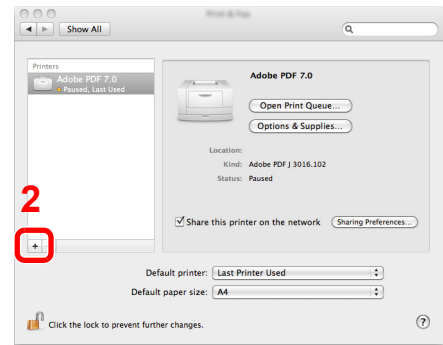
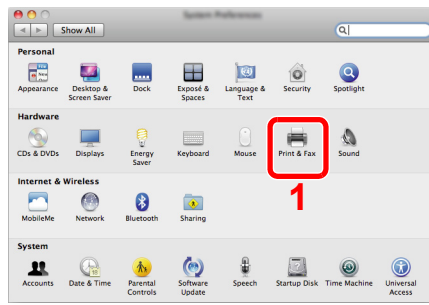

2 Click the IP icon for an IP connection and then enter the IP address and printer name.

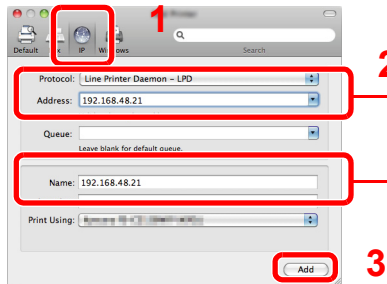

The number entered in "Address" will automatically appear in "Name". Change if needed.



NOTE

When using a Bonjour connection, select **[Default]** and click the item that appears in "Printer Name". The driver with the same name as the machine automatically appears in "Driver".

3 Select the options available for the machine and click Continue.

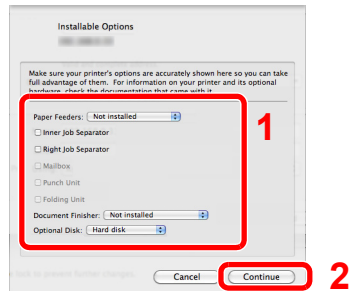

4 The selected machine is added.

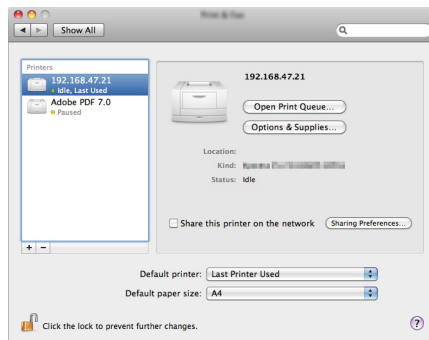

Setting TWAIN Driver

Register this machine to the TWAIN Driver. Instructions are based on interface elements as they appear in Windows 7.

1 Display the screen.

- 1 Select **[Start]** button on the Windows, **[All Programs]**, **[Kyocera]** and then **[TWAIN Driver Setting]**. TWAIN Driver screen appears.

In Windows 8, select **[Search]** in charms, **[Apps]**, and then **[TWAIN Driver Setting]**.

- 2 Click **[Add]**.

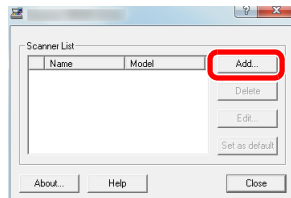

2 Configure TWAIN Driver.

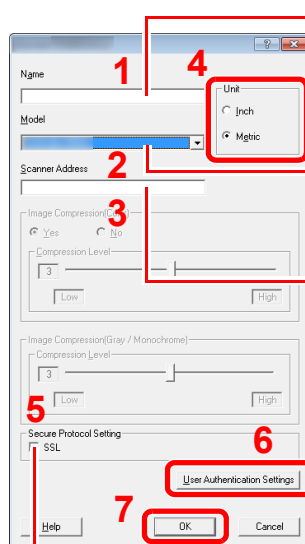

Enter the machine name.

When a model name without "(BOX)" is selected, the unit option appears. Set units of measurement.

Select this machine from the list. To scan a document stored in a custom box in this machine, select a model name with (Box) from "Model".

Enter the machine's IP address or host name.

When user login administration is enabled
 Select the checkbox beside **[Authentication]**, and enter Login User Name (up to 321 characters) and Password (up to 64 characters).
 When job accounting is enabled, select the checkbox beside **[Account]**, and enter the account ID as many as eight digits.

When using SSL, select the checkbox beside SSL.



NOTE

When the machine's IP address is unknown, contact Administrator.

For information on login user names and passwords, refer to [User Login on page 9-4](#).

For information on account IDs, refer to [Job Accounting Setting on page 9-27](#).

3 Finish registering.

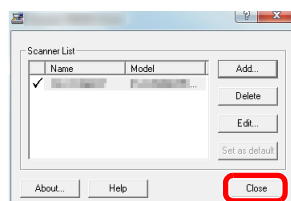

NOTE

Click **[Delete]** to delete the added machine. Click **[Edit]** to change names.

Setting WIA Driver

Register this machine to the WIA Driver. Instructions are based on interface elements as they appear in Windows 7.

1 Display the screen.

- 1 Click **[Start]** button on the Windows and enter **[Scanner]** in **[Program and File Search]**. Click **[View scanners and cameras]** in the search list then the Scanners and Cameras screen appears.

In Windows 8, click **[Search]** in charms, and then **[Settings]**, and enter "Scanner" in the search box. Click **[View scanners and cameras]** in the search list then the Scanners and Cameras screen appears.

- 2 Select the same name as this machine from WIA Drivers, and press **[Properties]**.

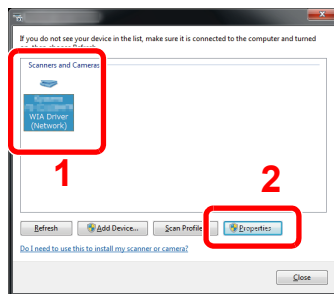

2 Configure WIA Driver.

Enter the machine IP addresses or host name. When using SSL, select the checkbox beside SSL.

Set units of measurement.

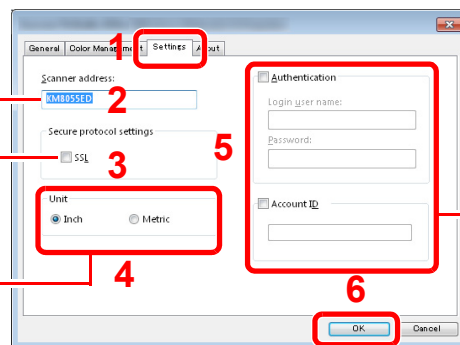

When user login administration is enabled

Select the checkbox beside **[Authentication]**, and enter Login User Name (up to 321 characters) and Password (up to 64 characters).

When job accounting is enabled, select the checkbox beside **[Account]**, and enter the account ID as many as eight digits.



NOTE

For information on login user names and passwords, refer to [User Login on page 9-4](#).

For information on account IDs, refer to [Job Accounting Setting on page 9-27](#).

Login/Logout

If you are setting a function that requires administrator rights, or if user login administration is enabled, you must enter your login user name and login password.

NOTE

- The factory default settings for the login user name and login password with administrator permissions are shown below.

Model Name	Login User Name	Login Password
3501i	3500	3500
4501i	4500	4500
5501i	5500	5500

You will be unable to login if you forget your login user name or login password. In this event, login with administrator privileges and change your login user name or login password.

- When User Login is enabled, a login user name and login password are required. For details, refer to [User Login on page 9-4](#).
- If the guest authentication setting is enabled, the [[Authentication/Logout](#)] key must be pressed when logging in. For details, refer to the [Guest Authorization Set. on page 9-18](#).

Login

Normal login

1 Enter the login user name and login password to login.

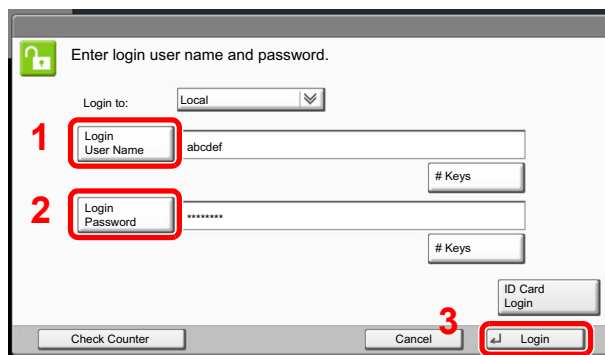

 [Character Entry Method \(page 11-10\)](#)

If this screen is displayed during operations, press [Login User Name] to enter the login user name.

Alternatively, you can login by pressing [Login Password] and entering the login password.

NOTE

[# Keys] can be pressed to enter the number with the numeric keys on the operation panel.

If [Network Authentication] is selected as the user authentication method, either [Local] or [Network] can be selected as the authentication destination.

To authenticate by ID card, press [ID Card Login].

Simple Login

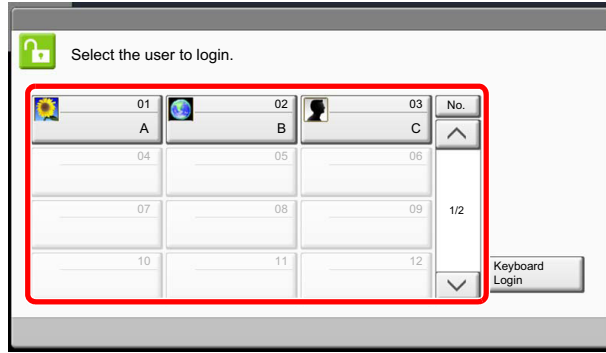

If this screen is displayed during operations, select a user and log in.



NOTE

If a login password is required, an input screen will be displayed.



[Simple Login \(page 9-23\)](#)

Logout



To logout from the machine, press the [**Authentication/Logout**] key to return to the login user name/login password entry screen.

Users are automatically logged out in the following circumstances:

- When the machine is put to Sleep by pressing the [**Power**] key.
- When the Auto Sleep function is activated.
- When the auto panel reset function is activated.
- When Auto Low Power Mode is activated.
- When the machine is placed in Low Power Mode by pressing the [**Energy Saver**] key.

Default Settings of the Machine

The default settings of the machine can be changed in System Menu. Before using this machine, configure such settings as date and time, network configuration, and energy saving functions as needed.

NOTE

For settings that are configurable from System Menu, refer to [Setup and Registration \(System Menu\) \(page 8-1\)](#).

Setting Date and Time

Follow the steps below to set the local date and time at the place of installation.

When you send an E-mail using the transmission function, the date and time as set here will be printed in the header of the E-mail message. Set the date, time and time difference from GMT of the region where the machine is used.

NOTE

If user login administration is enabled, you can only change the settings by logging in with administrator privileges. If user login administration is disabled, the user authentication screen appears. Enter a login user name and password, and press [Login].

The factory default login user name and login password are set as shown below.

Model Name	Login User Name	Login Password
3501i	3500	3500
4501i	4500	4500
5501i	5500	5500

Be sure to set the time difference before setting the date and time.

If you change the date/time while using the trial version of an application, you will no longer be able to use the application.

 [Application \(page 5-10\)](#)
[Optional Applications \(page 11-8\)](#)

1 Display the screen.

Press the [System Menu] key and select [Date/Timer/Energy Saver].

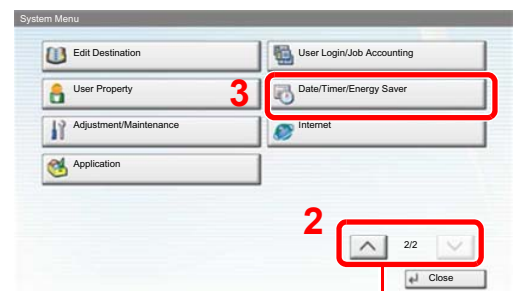
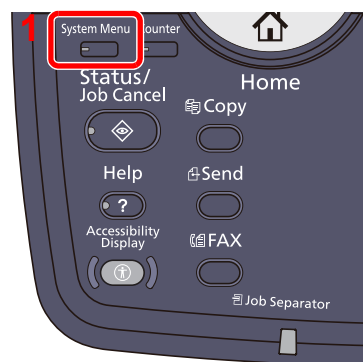

Press [^] or [v] to scroll up and down.

2 Configure the settings.

1 Set the time zone.

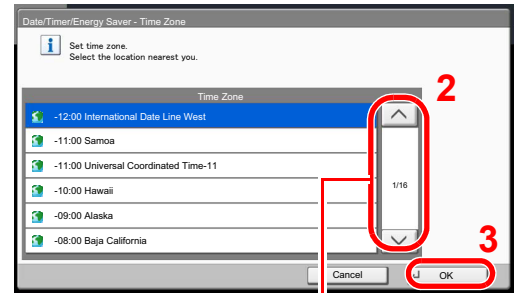
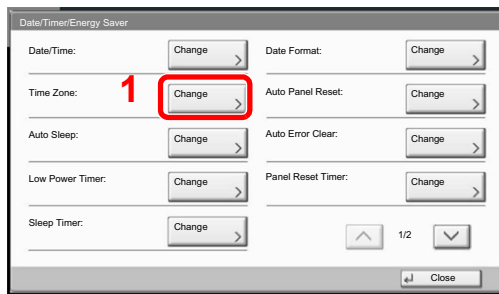

Press [^] or [v] to scroll up and down.

2 Set the summer time.

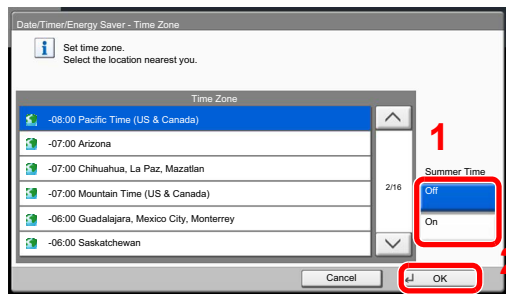

NOTE

If you select a region that does not utilize summer time, the summer time setting screen will not appear.

3 Set the date and time.

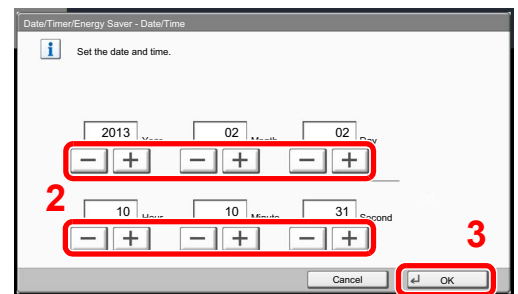
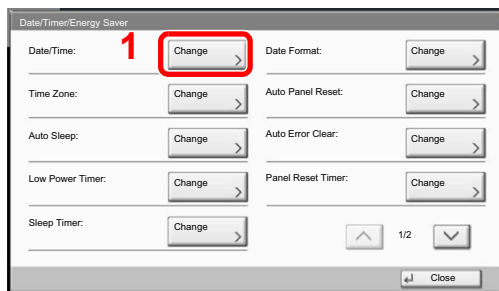

Press [+] or [-] in each setting.

Network Setup (LAN Cable Connection)

The machine is equipped with network interface, which is compatible with network protocols such as TCP/IP (IPv4), TCP/IP (IPv6), IPX/SPX, NetBEUI, and IPSec. It enables network printing on the Windows, Macintosh, UNIX, NetWare and other platforms.

This section explains the procedure of IPv4 and Bonjour settings for TCP/IP settings. For other network settings, refer to the [Network on page 8-43](#).

NOTE

If user login administration is enabled, you can only change the settings by logging in with administrator privileges. If user login administration is disabled, the user authentication screen appears. Enter a login user name and password, and press [Login].

The factory default login user name and login password are set as shown below.

Model Name	Login User Name	Login Password
3501i	3500	3500
4501i	4500	4500
5501i	5500	5500

TCP/IP Settings

IPv4 setting

Set up TCP/IP (IPv4) to connect to the Windows network.

The default settings are "TCP/IP Protocol: On, DHCP: On, Auto-IP: On".

NOTE

- Ask your network administrator for the IP address in advance, and have it ready when you configure this setting. In the following cases, set the IP address of DNS server on the Command Center RX.
 - When using the host name with "DHCP" setting set to "Off"
 - When using the DNS server with IP address that is not assigned by DHCP automatically.

Refer to the **Command Center RX User Guide**.

1 Display the screen.

- 1 Press the [System Menu] key and select [System/Network].

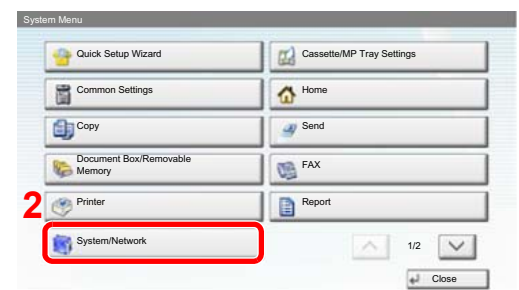

2 Select "Network" and then "TCP/IP Setting".

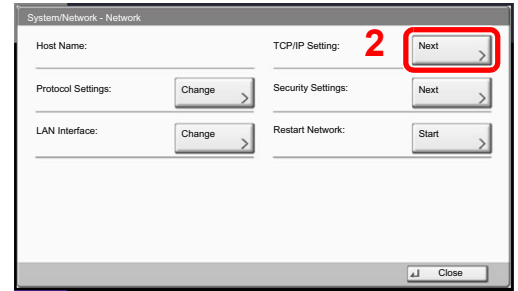
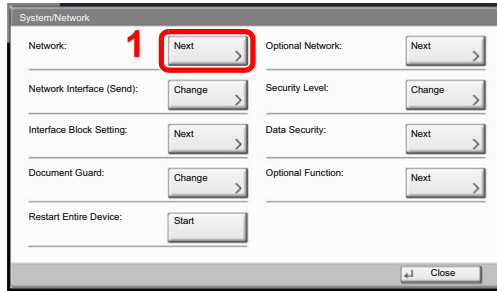

2 Configure the settings.

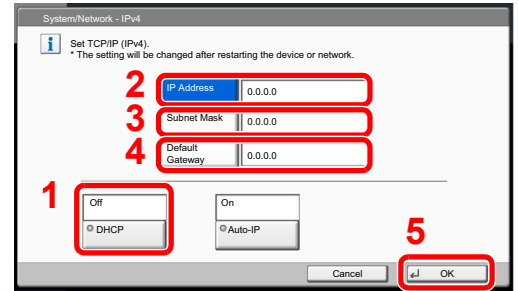
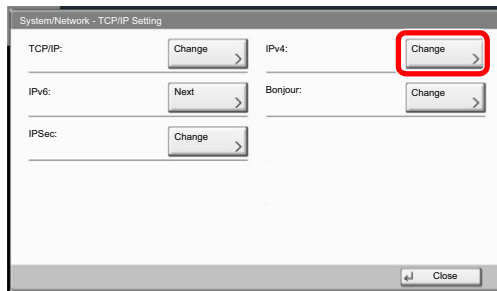

When using DHCP server

[DHCP]: Set to [On].

When setting the static IP address

[DHCP]: Set to [Off].

[IP Address]: Enter the address.

[Subnet Mask]: Enter the address.

[Default Gateway]: Enter the address.

 **IMPORTANT**

After changing the setting, restart the network from System Menu, or turn the machine OFF and then ON.

 [Restart Network \(page 8-46\)](#)

Bonjour Settings

Configure the settings for Bonjour.

1 Display the screen.

- 1 Press the [System Menu] key and select [System/Network].

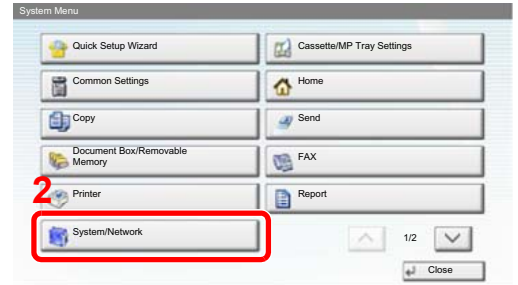
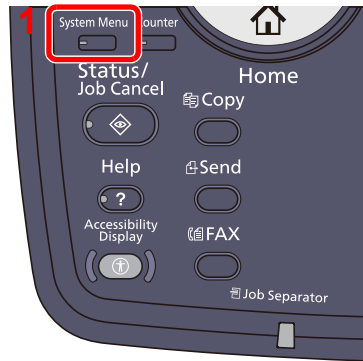

- 2 Select "Network" and then "TCP/IP Setting".

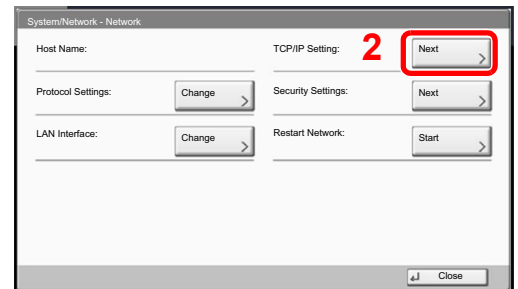
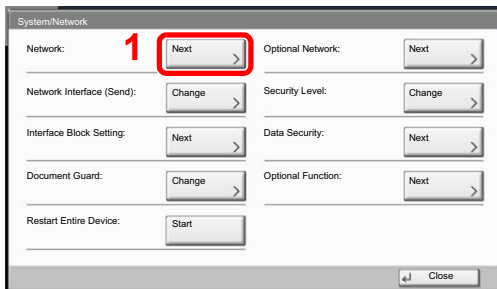

2 Configure the settings.

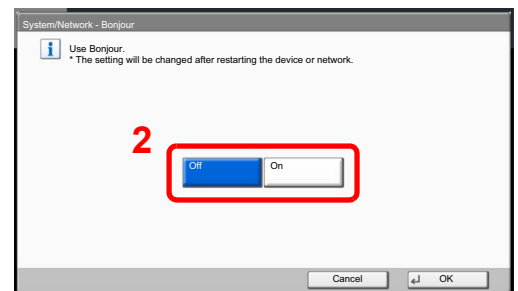
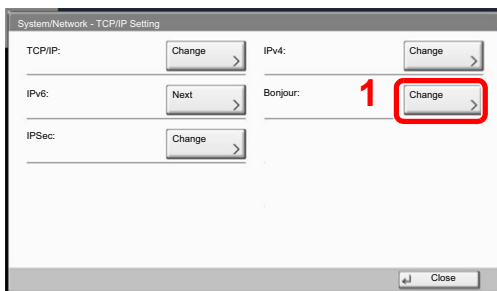

✔ IMPORTANT

After changing the setting, restart the network from System Menu, or turn the machine OFF and then ON.

 [Restart Network \(page 8-46\)](#)

Quick Setup Wizard

For Energy Saver and FAX functions, the following settings can be configured in a wizard-style screen.

Energy Saver Setup	Configures sleep mode and low-power mode.	
	1. Sleep Mode	For Europe Sleep Timer Sleep Rules Except for Europe Sleep Timer Sleep Level
	2. Auto Low Power Mode	Low Power Timer
	3. Recovery Mode	Energy Saver Recovery Level
	4. Weekly Timer Settings	Weekly Timer Settings Schedule Retry Times Retry Interval
FAX Setup	Configures basic fax settings. This function is displayed when the optional fax is installed. Refer to the FAX Operation Guide .	

 **NOTE**

If the user authentication screen appears, enter your login user name and login password and press [Login].
The factory default login user name and login password are set as shown below.

Model Name	Login User Name	Login Password
3501i	3500	3500
4501i	4500	4500
5501i	5500	5500

1 Display the screen.

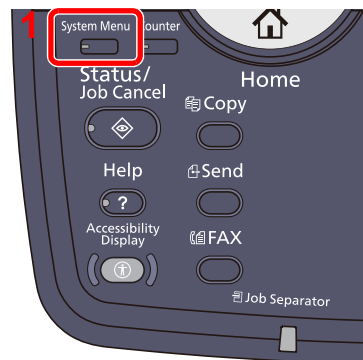

2 Select a function.

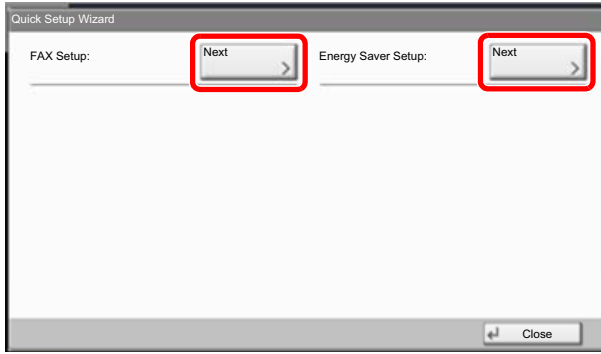

3 Configure the settings.

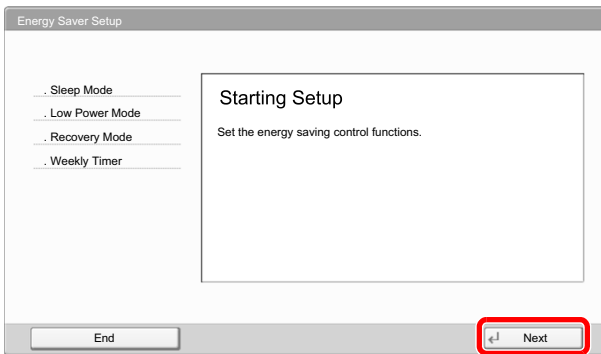

Start the wizard. Follow the instructions on the screen to configure settings.



NOTE

If you experience difficulty configuring the settings, refer to [Help Screen on page 3-12](#).

Control	Description
End	Exits the wizard. Settings configured so far are applied.
Previous	Returns to the previous item.
Skip	Advances to the next item without setting the current item.
Next	Advances to the next screen.
Back	Returns to the previous screen.
Complete	Register the settings and exit the wizard.

Checking the Counter

Press the [Counter] key to check the number of sheets printed and scanned.

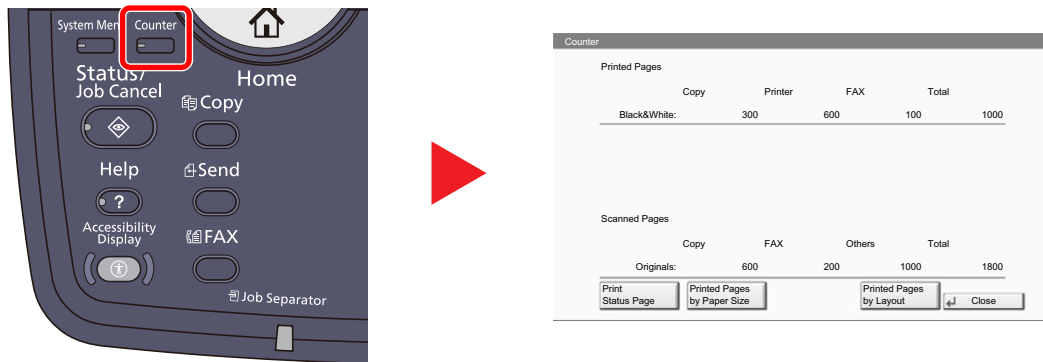

You can check the number of pages printed in each paper size by pressing [Printed Pages by Paper Size].

Additional Preparations for the Administrator

In addition to the information provided in this chapter, the administrator of this machine should check the following, and configure the settings as needed.

To Send Documents to a PC

To send a document that has been loaded, you need to create a shared folder to receive the document on your computer.

For details, refer to [Preparation for Sending a Document to a PC on page 3-36](#).

To E-mail Scanned Images

When sending documents by E-mail or to FTP, it may be useful to store the destinations in the Address Book. For each registration method, refer to [Registering Destinations in the Address Book on page 3-46](#).

To Strengthen the Security

This machine is shipped with two default users registered one with Machine Administrator rights, and another with Administrator rights. Logging in as this user will allow you to configure all settings; therefore, please change the login user name and password.

In addition, this machine is equipped with user authentication function, which can be configured to limit the access to this machine to only those who have a registered login name and password. For each setting procedure, refer to [User Authentication and Accounting \(User Login, Job Accounting\) \(page 9-1\)](#).

I want to...	Function	Reference page
Restrict the users of the machine.	User Login	page 9-2
	Authentication Security	page 9-6
	Auto Panel Reset	page 8-54
	ID Card Settings* ¹	page 9-26
Restrict the basic functions that can be used.	Local Authorization	page 9-15
	Group Authorization Set.	page 9-15
	Guest Authorization Set.	page 9-18
Prevent another user from handling the documents stored in the machine.	Custom Box	page 5-53
Output the document stored in the machine at the time when user operates the device via operation panel.	Remote Printing	page 8-27
Prevent the data stored in the machine from being leaked.	Data Overwrite* ²	Refer to the Data Security Kit (E) Operation Guide .
	Encryption* ²	
	PDF Encryption Functions	page 6-60
	Document Guard* ³	page 8-51
Completely delete the data on the hard disk before disposing of the machine.	Data Sanitization	page 8-50
Record the operation history of users.	Login History Settings	page 8-40
	Device Log History Settings	page 8-41
	Secure Comm. Error Log	page 8-42

I want to...	Function	Reference page
Protect the transmission from interception and wiretapping.	IPP over SSL	page 8-45
	HTTPS	page 8-46
	LDAP Security	Refer to the Command Center RX User Guide.
	SMTP Security	Refer to the Command Center RX User Guide.
	POP3 Security	Refer to the Command Center RX User Guide.
	FTP Encrypted TX	page 6-63
	Enhanced WSD (SSL)	page 8-46
	IPSec	page 8-44
	SNMPv3	page 8-46
Verify the software in the machine.	Software Verification	page 8-50

*1 The optional Card Authentication Kit is required.

*2 The optional Data Security Kit is required.

*3 The optional Printed Document Guard Kit is required.

Command Center RX

If the machine is connected to the network, you can configure various settings using Command Center RX. This section explains how to access Command Center RX, and how to change security settings and the host name. For details on Command Center RX, refer to the **Command Center RX User Guide**.

NOTE

To fully access the features of the Command Center RX pages, enter the User Name and Password and click [\[Login\]](#). Entering the predefined administrator password allows the user to access all pages, including Document Box, Address Book, and Settings on the navigation menu. The factory default setting for the default user with administrator privileges is shown below.

Login User Name	Admin
Login Password	Admin

* Upper case and lower case letters are distinguished (case sensitive).

Settings that the administrator and general users can configure in Command Center RX are as follows.

Setting	Description	Administ-rator	General User
Device Information	The machine's structure can be checked. [Configuration] , [Counter] , [About Command Center RX]	<input type="radio"/>	<input type="radio"/>
Job Status	Displays all device information, including print and scan jobs, storing jobs, scheduled jobs, and job log history. [Printing Jobs Status] , [Printing Job Log] , [Sending Job Status] , [Scheduled Jobs] , [Sending Job Log] , [Storing Job Status] , [Storing Job Log]	<input type="radio"/>	<input type="radio"/>
Document Box	Add or delete document boxes, or delete documents within a document box. [Custom Box] , [FAX Box]*1 , [Polling Box]*1 , [Job Box Settings]	<input type="radio"/>	<input type="radio"/> *2
Address Book	Create, edit, or delete addresses and address groups. [Machine Address Book] , [External Address Book Settings] , [One Touch Key]	<input type="radio"/>	<input type="radio"/> *2
Device Settings	Configure the advanced settings of the machine. [Paper/Feed/Output] , [Original Settings] , [Energy Saver/Timer] , [Date/Time] , [System]	<input type="radio"/>	-
Function Settings	Configure the advanced function settings. [Common/Job Defaults] , [Copy] , [Printer] , [E-mail] , [Scan to Folder] , [DSM Scan] , [FAX / i-FAX]*1 , [Send and Forward] , [RX/Forward Rules]*1 , [Operation Panel]	<input type="radio"/>	-
Network Settings	Configure the network advanced settings. [General] , [TCP/IP] , [Protocol]	<input type="radio"/>	-
Security Settings	Configure the security advanced settings. [Device Security] , [Send Security] , [Network Security] , [Certificates]	<input type="radio"/>	-
Management Settings	Configure the advanced management settings. [Job Accounting] , [Authentication] , [ID Card] , [Notification/Report] , [History Settings] , [SNMP] , [System Stamp] , [Message Board] , [Reset]	<input type="radio"/>	-

*1 Displayed only when the optional FAX Kit is installed.

*2 The logged in user may not be able to configure some settings, depending on the permissions of the user.

NOTE

The optional FAX Kit is required in order to make use of fax functionality. Here, information on the FAX settings has been omitted. For more information on using the FAX, refer to the **FAX Operation Guide**.

Accessing Command Center RX

1 Display the screen.

- 1 Launch your Web browser.
- 2 In the address or location bar, enter the machine's IP address or the host name.

Examples: <https://192.168.48.21/> (for IP address)
<https://MFP001> (if the host name is "MFP001")

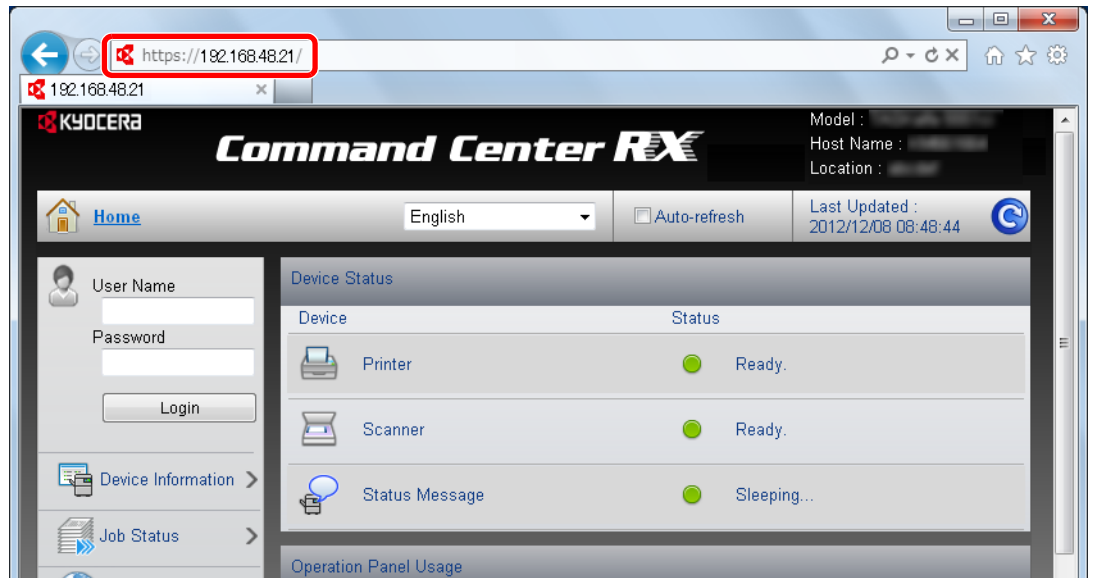

The web page displays basic information about the machine and Command Center RX as well as their current status.



NOTE

If the screen "There is a problem with this website's security certificate." is displayed, configure the certificate. For details on Certificates, refer to the **Command Center RX User Guide**.

You can also continue the operation without configuring the certificate.

2 Configure the function.

Select a category from the navigation bar on the left of the screen. When you log in to the machine as an administrator, you will see [\[Device Settings\]](#), [\[Function Settings\]](#), [\[Network Settings\]](#), [\[Security Settings\]](#), and [\[Management Settings\]](#).

Changing Security Settings

This section explains how to change the security settings.

1 Display the screen.

Access Command Center RX by referring to [Accessing Command Center RX on page 2-34](#).

2 Configure the Security Settings.

From the [[Security Settings](#)] menu, select the setting you want to configure. The configurable settings are [[Device Security](#)], [[Send Security](#)], [[Network Security](#)], and [[Certificates](#)].

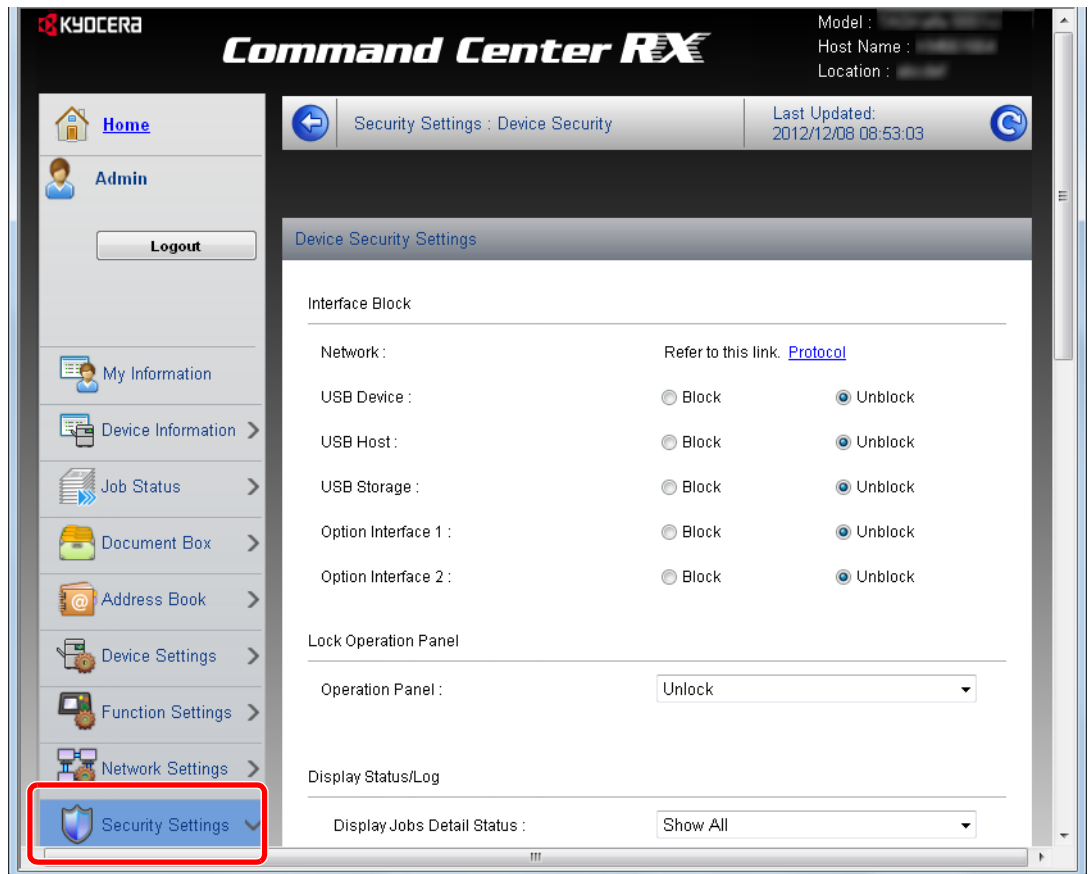

NOTE

The configurable settings within [[Device Security](#)], [[Send Security](#)], and [[Network Security](#)] can also be configured from the machine's System Menu. For details, see [Setup and Registration \(System Menu\) \(page 8-1\)](#).

For details on settings related to certificates, refer to the **Command Center RX User Guide**.

Changing Device Information

Change the device information of the machine.

1 Display the screen.

- 1 Access Command Center RX by referring to [Accessing Command Center RX on page 2-34](#).
- 2 From the [Device Settings] menu, select [System].

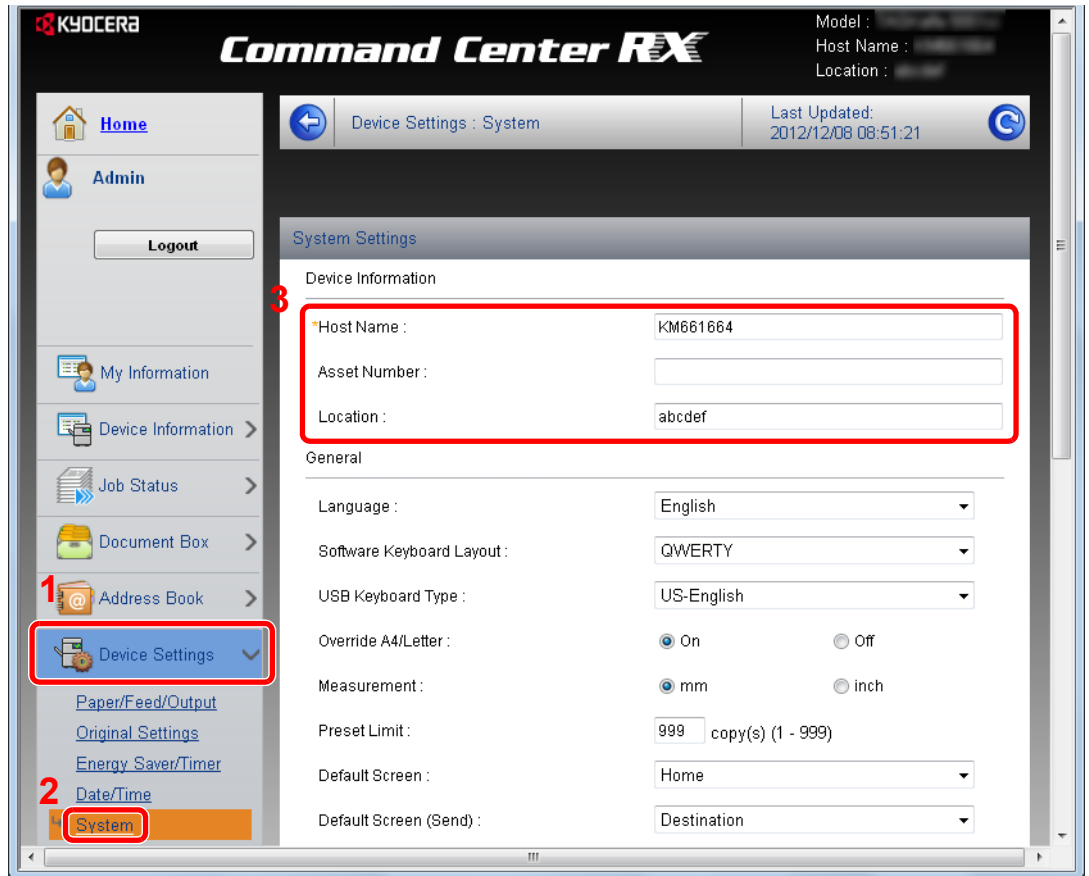

2 Specify the host name.

Enter the device information, and then click [Submit].

✔ IMPORTANT

After changing the setting, restart the network or turn the machine OFF and then ON.

To restart the network interface card, click [Reset] in the [Management Settings] menu, and then click [Restart Network] in "Restart".

E-mail settings

By configuring the SMTP settings, you can send E-mail notifications on completed jobs.

To use this function, this machine must be connected to a mail server using the SMTP protocol.

In addition, check the following.

- The network environment used to connect this machine to the mail server
A full-time connection via a LAN is recommended.
- SMTP settings
Use Command Center RX to register the IP address or host name of the SMTP server.
- If limits have been set on the size of E-mail messages, it may not be possible to send very large E-mails.

The procedure for specifying the SMTP settings is explained below.

1 Display the screen.

- 1 Access Command Center RX by referring to [Accessing Command Center RX on page 2-34](#).
- 2 From the [Function Settings] menu, click [E-mail].

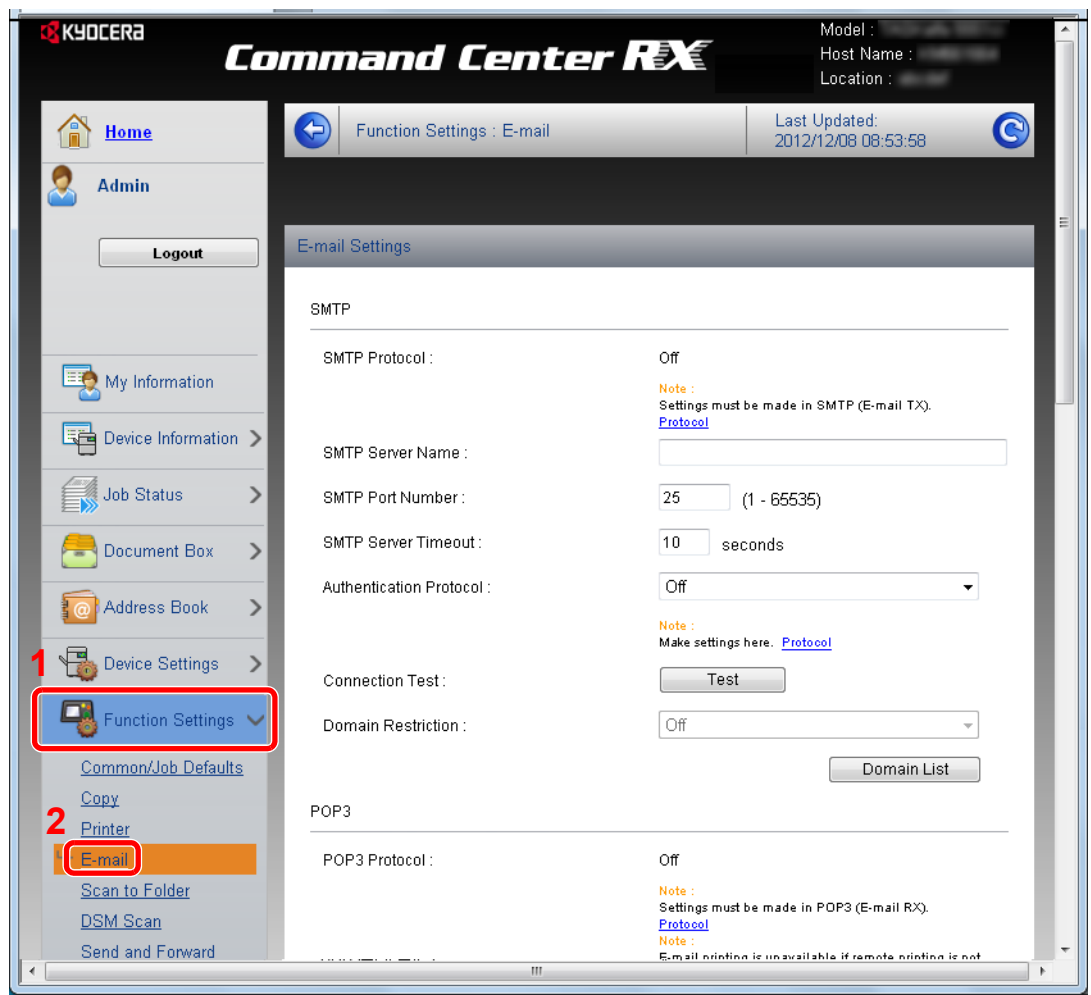

2 Configure the settings.

Enter the appropriate values to each field.

Setting	Description
SMTP	Set to send e-mail from the machine.
SMTP Protocol	Set SMTP protocol. Set the "SMTP (E-mail TX)" setting to [On] on the [Protocol Settings] page.
SMTP Server Name	Enter the host name or IP address of the SMTP server.
SMTP Port Number	Specify the port number to be used for SMTP. Use the SMTP default port 25.
SMTP Server Timeout	Set the amount of time to wait before time-out in seconds.
Authentication Protocol	Set whether SMTP authentication is used. To use authentication, enter the user information for authentication.
SMTP Security	Set SMTP security. Turn on "SMTP Security" in "SMTP (E-mail TX)" on the [Protocol Settings] page.
POP before SMTP Timeout	Specify the time in seconds until the connection to the POP server times out. This can be set when [POP before SMTP] is selected in "Authentication Protocol".
Connection Test	Tests to confirm that the settings are correct.
Domain Restriction	Set whether or not domains are restricted. Click the [Domain List] and enter the domain names of addresses to be allowed or rejected. Restriction can also be specified by e-mail address.
POP3	Set to receive e-mail at the machine.
POP3 Protocol	Set POP3 protocol. Set the "POP3 (E-mail RX)" setting to [On] on the [Protocol Settings] page.
Check Interval	Specify the interval for checking for incoming e-mail in minutes.
Run once now	Click [Receive] to connect to the POP3 server immediately and check for incoming E-mails.
Domain Restriction	Set whether or not domains are restricted. Click the [Domain List] and enter the domain names of addresses to be allowed or rejected. Restriction can also be specified by e-mail address.
POP3 User Settings	Configure the settings for POP3 user accounts and the POP3 server. You can configure up to three users.

Setting		Description
E-mail Send Settings	E-mail Size Limit	Enter the maximum size of E-mail that can be sent in kilobytes. When E-mail size is greater than this value, an error message appears and E-mail sending is cancelled. Use this setting if you have set E-mail Size Limit for SMTP server. If not, enter a value of 0 (zero) to enable E-mail sending regardless of the size limit.
	Sender Address	Enter the E-mail address of the person responsible for the machine, such as the machine administrator, so that a reply or non-delivery report will go to a person rather than to the machine. The sender address must be entered correctly for SMTP authentication. The maximum length of the sender address is 128 characters.
	Signature	Enter the signature. The signature is free form text that will appear at the end of the E-mail body. It is often used for further identification of the machine. The maximum length of the signature is 512 characters.
	Function Defaults	Change the function default settings in [Common/Job Default Settings] page.

3 Click [[Submit](#)].

Registering Destinations

You can register destinations to the machine's Address Book, from Command Center RX.

1 Display the screen.

- 1 Access Command Center RX by referring to [Accessing Command Center RX on page 2-34](#).
- 2 From the [[Address Book](#)] menu, click [[Machine Address Book](#)].



- 3 Click [[Add](#)].

2 Populate the fields.

- 1 Enter the destination information.

Enter the information for the destination you want to register. The fields to populate are the same as when registering via operation panel.

 [Registering Destinations in the Address Book \(page 3-46\)](#)

- 2 Click [[Submit](#)].

Registering a Custom Box

You can register a custom box from Command Center RX.

1 Display the screen.

- 1 Access Command Center RX by referring to [Accessing Command Center RX on page 2-34](#).
- 2 From the [Document Box] menu, click [Custom Box].



- 3 Click [Add].

2 Configure the Custom Box.

- 1 Enter the box details.

Enter the information for the custom box you want to register. The fields to populate are the same as when registering on the machine.

 [Creating a New Custom Box \(Add/Edit Box\) \(page 5-53\)](#)

- 2 Click [Submit].

Printing a document stored in a Custom Box

A document stored in a Custom Box can be printed from Command Center RX.

1 Display the screen.

- 1 Access Command Center RX by referring to [Accessing Command Center RX on page 2-34](#).
- 2 From the [Document Box] menu, click [Custom Box].



- 3 Click the number or name of the Custom Box in which the document is stored.

2 Print the document.

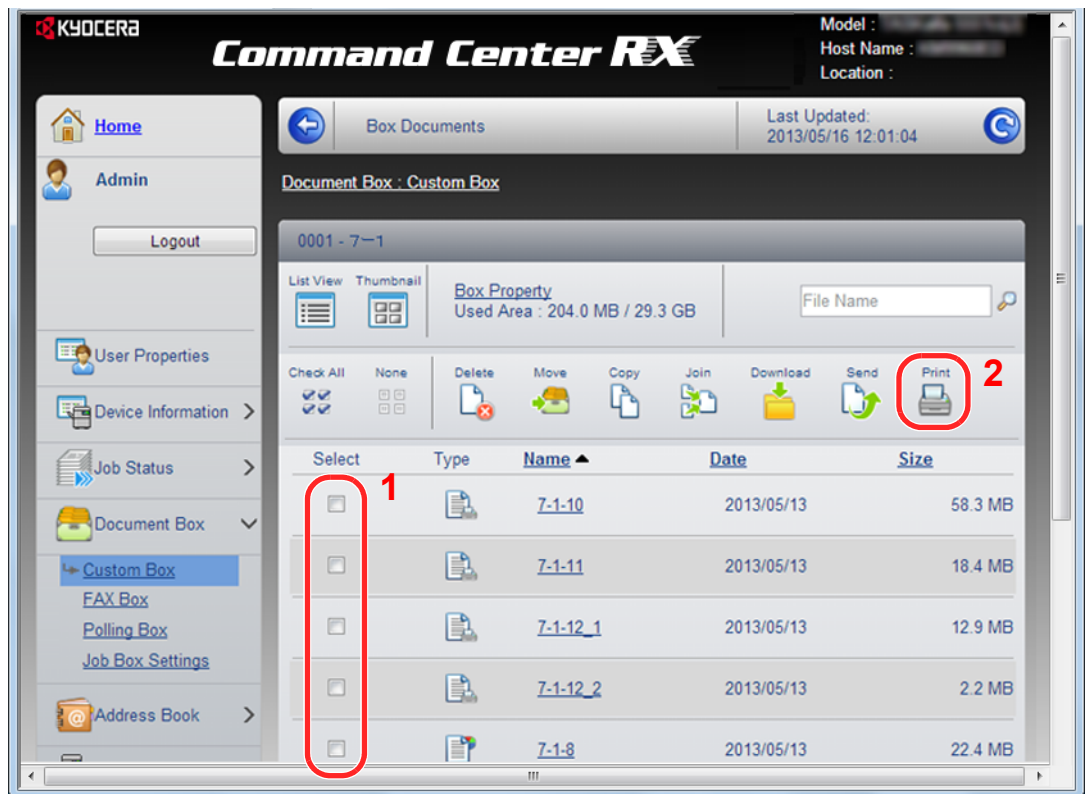

- 1 Select the document you wish to print.

Select the checkbox of the document to be printed.

- 2 Click [**Print**].

For settings that are configurable, refer to **Command Center RX User Guide**.

Transferring data from our other products

By using the machine's utility, you can smoothly migrate address books when the machine is to be replaced. This section explains how to transfer data between our products.

Migrating the Address Book

The Address Book registered on the machine can be backed up or migrated using the KYOCERA Net Viewer on the included DVD.

For details on operating the KYOCERA Net Viewer, refer to the **KYOCERA Net Viewer User Guide**.



NOTE

KYOCERA Net Viewer is a utility for administrators. This utility can only be used by users with administrator permissions.

Backing Up Address Book Data to PC

- 1 Launch the KYOCERA Net Viewer.**
- 2 Create a backup.**

- 1 Right-click on the model name from which you want to back up the Address Book, and select **[Advanced]** - **[Set multiple devices]**.

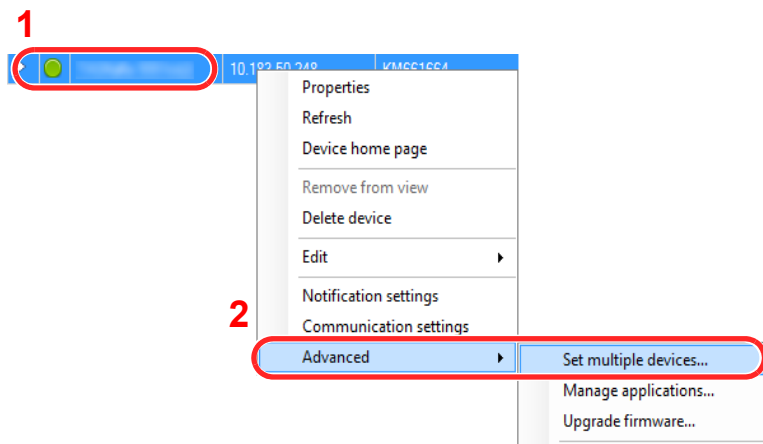

- 2 Click **[Next]**.
- 3 Select **[Device Address Book]** and click **[Next]**.

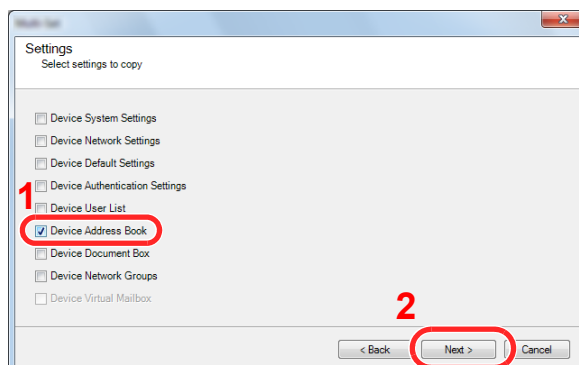

- 4 Select [**Create from device**] and remove the checkmark from [**Overwrite settings on target device**], and then click [**Next**].

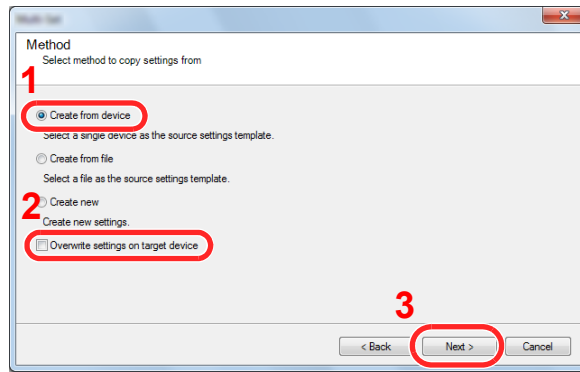

- 5 Select the model you want to back up, and click [**Next**].

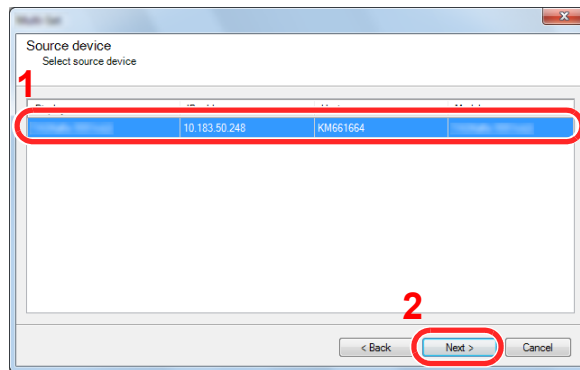

NOTE

If the "Admin Login" screen appears, enter the "Admin Login" and "Login Password", and then click [**OK**]. The default settings are as follows:

Login User Name	Admin
Login Password	Admin

* Upper case and lower case letters are distinguished (case sensitive).

- 6 Click on [**Save to file**].

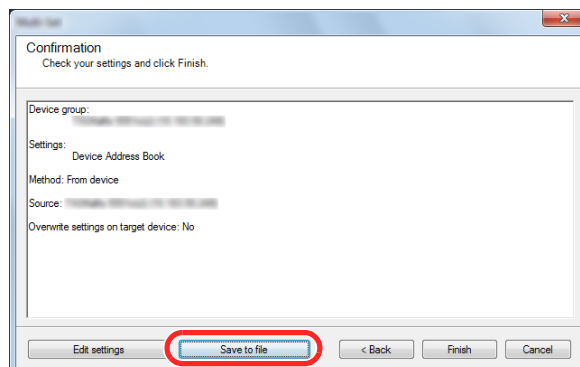

- 7 Specify the location to save the file, enter the file name, and then click [**Save**].
For "Save as type", make sure to select "XML File".

- 8 After saving the file, always click [**Cancel**] to close the screen.

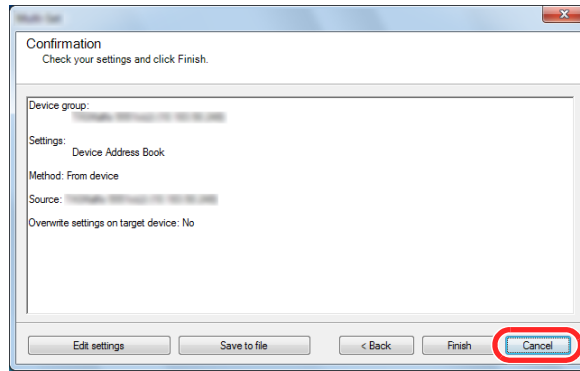

Please note that selecting [**Finish**] will write the data to the machine's Address Book.

Writing Address Book Data to the Machine

- 1 **Launch the KYOCERA Net Viewer.**

- 2 **Load the Address Book data.**

- 1 Right-click on the model name to which you want to transfer the Address Book, and select [**Advanced**] - [**Set multiple devices**].

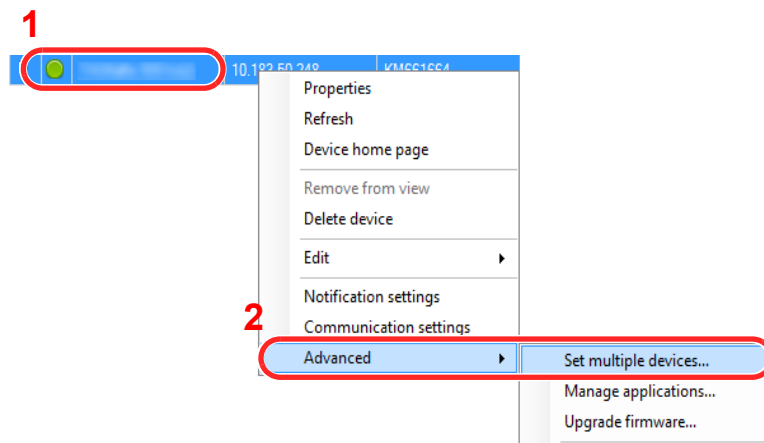

- 2 Click [**Next**].

- 3 Select [**Device Address Book**] and click [**Next**].

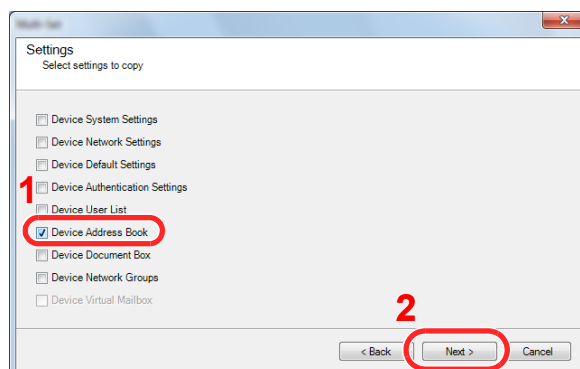

- 4 Select **[Create from file]** and remove the checkmark from **[Overwrite settings on target device]**, and then click **[Next]**.

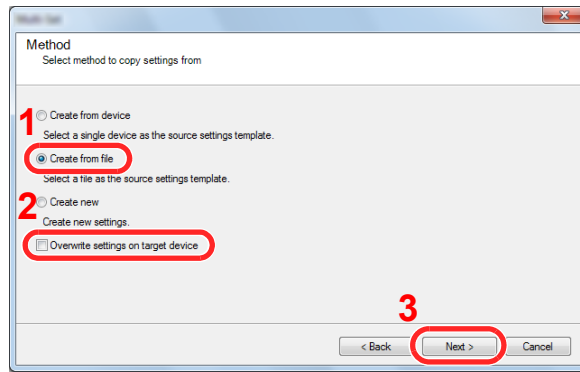

Selecting the **[Overwrite settings on target device]** checkbox will overwrite the machine's Address Book from entry No.1.

- 5 Click **[Browse]** and select the backup Address Book file, and then click **[Next]**.

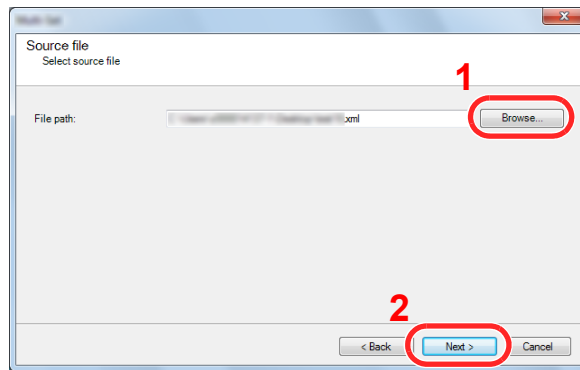

- 6 Click **[Finish]**.

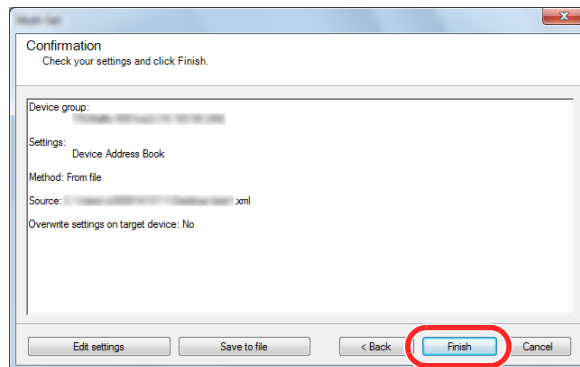

The write process of the Address Book data starts.

- 7 Once the write process is complete, click **[Close]**.









3 Preparation before Use





This chapter explains the following operations.

Using the Operation Panel	3-2
Operation Panel Keys	3-2
Adjusting the Operation Panel Angle	3-3
Touch Panel Display	3-4
Home Screen	3-4
Display for Originals and Paper	3-8
Display of keys that cannot be set	3-8
Original Preview	3-9
Enter key and Quick No. Search key	3-11
Help Screen	3-12
Accessibility Functions (Magnifying the View)	3-13
Energy Saver function	3-14
Low Power Mode and Auto Low Power Mode	3-14
Sleep and Auto Sleep	3-15
Loading Paper	3-16
Before Loading Paper	3-17
Loading in the Cassettes	3-18
Loading Paper in the Multi Purpose Tray	3-26
Paper stopper	3-30
Specifying Paper Size and Media	3-31
Preparation for Sending a Document to a PC	3-36
Making a note of the computer name and full computer name	3-36
Making a note of the user name and domain name	3-37
Creating a Shared Folder, Making a Note of a Shared Folder	3-38
Configuring Windows Firewall (for Windows 7)	3-42
Registering Destinations in the Address Book	3-46
Adding a Destination (Address Book)	3-46
Adding a Destination on One Touch Key (One Touch Key)	3-54





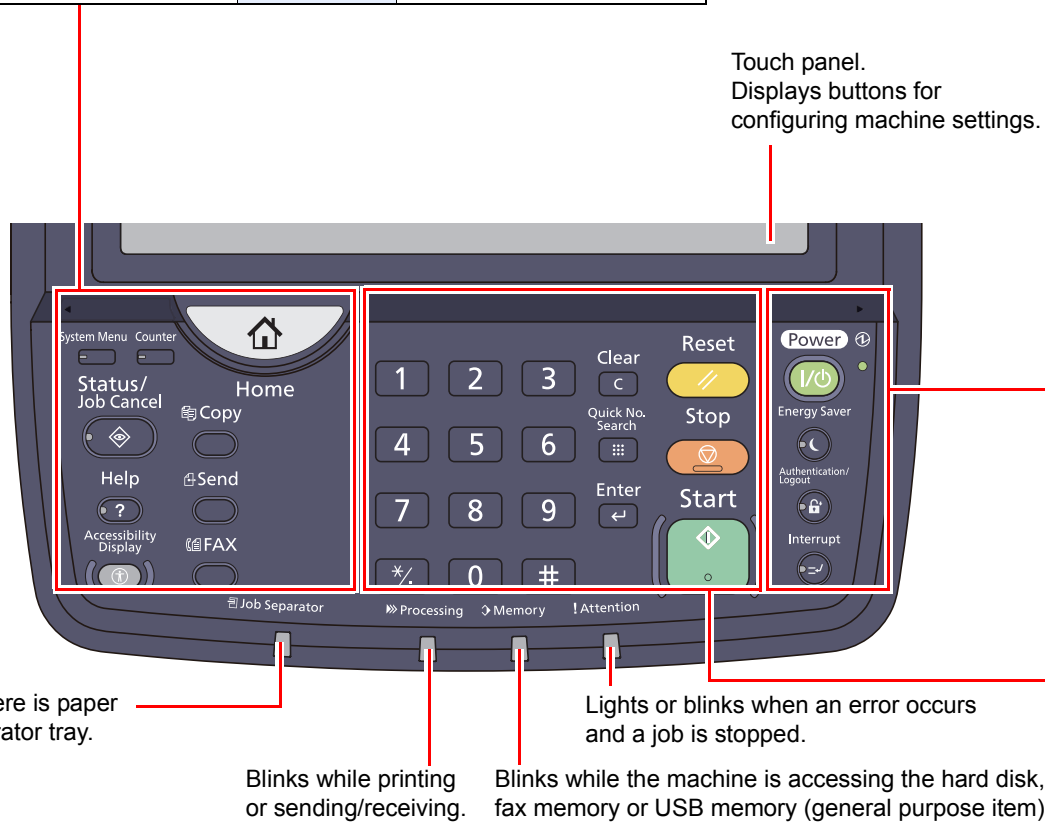

Using the Operation Panel

Operation Panel Keys

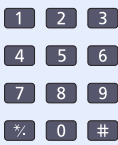
 Home Displays the Home screen.			
System Menu 	Displays the System Menu screen.	Counter 	Displays the Counter screen.
Status/Job Cancel 	Displays the Status/Job Cancel screen.	Copy 	Displays the Copy screen.
Help 	Displays the help guidance.	Send 	Displays the screen for sending. You can change it to display the Address Book screen.
Accessibility Display 	Switches the touch panel display on the Copy screen and the Send screen to a magnified view.	FAX 	Displays the FAX screen.

Power 	Puts the machine into Sleep Mode. Recovers from Sleep if in Sleep Mode.
Energy Saver 	Puts the machine into Low Power Mode.
Authentication/Logout 	Authenticates user switching, and exits the operation for the current user (i.e. log out).
Interrupt 	Displays the Interrupt Copy screen.
	Lit when the machine's main power is on.



	Numeric keys. Enter numbers and symbols.	Clear 	Clears entered numbers and characters.	Reset 	Returns settings to their default states.
		Quick No. Search 	Specifies registered information such as address numbers, user IDs and program numbers by number.	Stop 	Cancels or pauses the job in progress.
		Enter 	Finalizes numeric key entry, and finalizes details during setting of functions. Operates linked with the on-screen [OK].	Start 	Starts copying and scanning operations and processing for setting operations.

Adjusting the Operation Panel Angle

Adjust the angle of the operation panel in two as shown by releasing the operation panel lock lever.

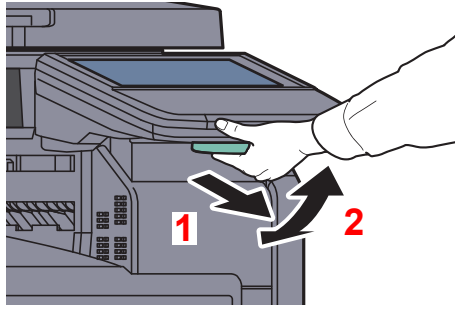

Touch Panel Display

Home Screen

This screen is displayed by pressing the [Home] key on the operation panel. Touching an icon will display the corresponding screen.

You can change the icons to display on the Home screen as well as its background.

 [Editing the Home Screen \(page 3-5\)](#)

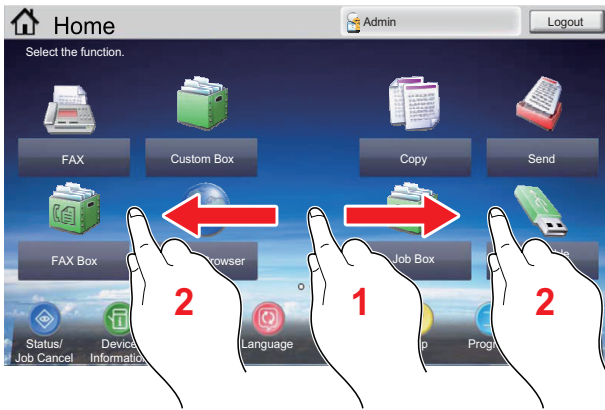

* The appearance may differ from your actual screen, depending on your configuration and option settings.

No.	Item	Description
1	Login User Name	Displays the logged-in user name. This is displayed when user login administration is enabled. Pressing "Login User Name" will display the information of the logged-in user.
2	[Logout]	Logs out the current user. This is displayed when user login administration is enabled.
3	Message	Displays the message depending on the status.
4	Desktop	Displays a maximum of 40 function icons* including the functions registered in program. Icons that are not displayed on the first page will appear by changing the page.
5	Screen-switching keys	Use these buttons to switch between desktop pages.  NOTE You can also switch views by touching the screen and moving the finger sideways (i.e. swiping). 
6	Taskbar	Displays a maximum of 8 task icons.

* When the optional FAX Kit is installed, a maximum of 42 icons can be displayed. A maximum of 5 icons can be displayed for installed applications.

Editing the Home Screen

You can change the background of the Home screen as well as which icons are displayed.

1 Display the screen.

Press the [System Menu] key and select [Home].

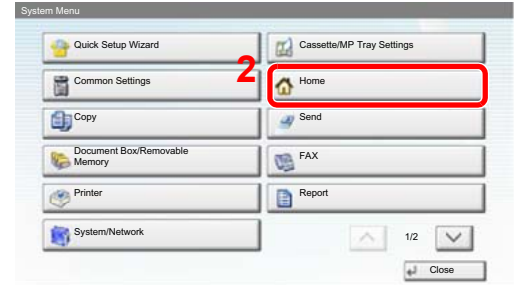

NOTE

You can only change the settings by logging in with administrator privileges.
The factory default login user name and login password are set as shown below.





Model Name	Login User Name	Login Password
3501i	3500	3500
4501i	4500	4500
5501i	5500	5500

2 Configure the settings.

The available settings are shown below.

Item	Description
Customize Desktop	Specify the function icons to display on the desktop. Press [Add] to display the screen for selecting the function to display. Select the function to display and press [OK]. Select an icon and press [Previous] or [After] to change the display position of the selected icon on the Desktop. To delete an icon from desktop, select the desired one and press [Delete]. For details, refer to Available Functions to Display on Desktop on page 3-6 .
Customize Taskbar	Specify the task icons to display on the taskbar. For details, refer to Available Functions to Display on Taskbar on page 3-7 .
Wallpaper	Configure the wallpaper of the Home screen. Value: Images 1 to 8

Available Functions to Display on Desktop











Function	Icon	Description	Reference page
Copy* ¹		Displays the Copy screen.	page 5-20
Send* ¹		Displays the Send screen.	page 5-23
FAX* ²		Displays the FAX screen.	Refer to the FAX Operation Guide .
Custom Box* ¹		Displays the Custom Box screen.	page 5-53
Job Box* ¹		Displays the Job Box screen.	page 4-14 page 5-65
Removable Memory* ¹		Displays the Removable Memory screen.	page 5-68
FAX Box* ²		Displays the FAX Box screen.	Refer to the FAX Operation Guide .
Internet Browser		Displays the Internet Browser screen.	page 5-16
Send to Me (E-mail)		Displays the Send screen. The E-mail address of the logged-in user is set as the destination.	page 6-66
Send to Me from Box (E-mail)		Displays the Custom Box screen. The E-mail address of the logged-in user is set as the destination.	page 6-66
Program		Calls up the registered program. The icon will change according to the function of the program.	page 5-6
Application Name	 * ³	Displays the selected applications.	page 5-10

*¹ Selected at the time of shipment from factory.

*² Displayed when the corresponding optional component is attached.

*³ The icon of the application appears.

Available Functions to Display on Taskbar

Function	Icon	Description	Reference page
Status/Job Cancel		Displays the Status screen. If an error occurs, the icon will show "!". Once the error clears, the display will return to normal.	-
Device Information		Displays the Device Information screen. Check the system and network information.	-
Accessibility/Standard		Magnifies the text and icons on the screen. Pressing the Accessibility icon switches the icon to the Standard icon. Press the Standard icon to return to the previous view.	page 3-13
Language		Displays the Language setting screen in System Menu.	page 8-9
System Menu		Displays the System Menu screen.	page 8-2
Help		Displays the Help screen.	page 3-12
Program		Displays the program list screen.	page 5-6
Message Board		Displays the Message Board screen.  NOTE To use this function, set "Message Board" to [ON] in System Menu.  Message Board Settings on page 8-27	page 8-27

Display for Originals and Paper

The copy screen displays the selected paper source and output tray.

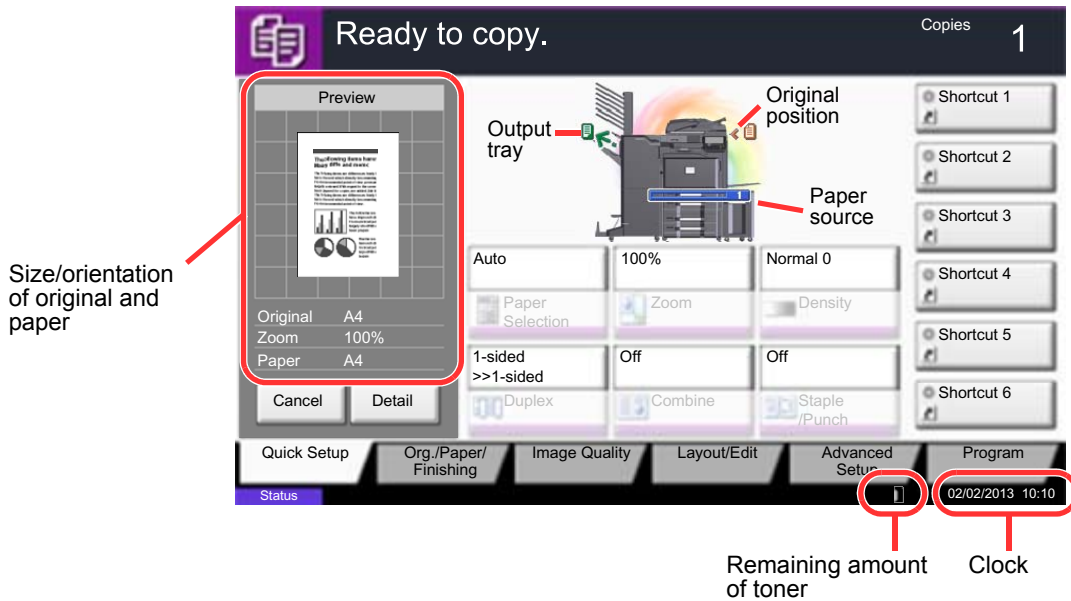

Display of keys that cannot be set

Keys of features that cannot be used due to feature combination restrictions or non-installation of options are in a non-selectable state.

Normal	Grayed out	Hidden
	<p>In the following cases, the key is grayed out and cannot be selected.</p> <ul style="list-style-type: none"> • Cannot be used in combination with a feature that is already selected. • Use prohibited by user control. • [Preview] has been pressed. (Refer to Original Preview on page 3-9) 	<p>Cannot be used because an option is not installed. Example: When a document finisher (1,000-Sheet Finisher or 4,000-Sheet Finisher) is not installed, [Staple/Punch] does not appear.</p>

NOTE

If a key that you wish to use is grayed out, the settings of the previous user may still be in effect. In this case, press the **[Reset]** key and try again.

If the key is still grayed out after the **[Reset]** key is pressed, it is possible that you are prohibited from using the function by user control. Check with the administrator of the machine.

Original Preview

You can display a preview image of the scanned document on the panel.

NOTE

To view a preview of an image stored in a Custom Box, refer to [Previewing Documents/Checking Document Details on page 5-51](#).

The procedure described here is for copying a single-page original.

- 1 On the Home screen, press [Copy] or [Send], and then place the original.

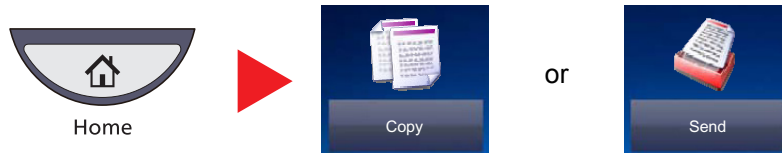

- 2 Press [Preview].

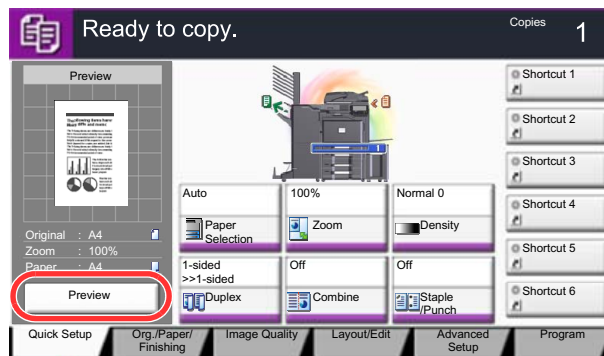

The machine starts scanning the original. When scanning is completed, the preview image appears on the panel.

- 3 Pressing [Detail] will display the Preview screen so that you can check the finished image in greater detail.

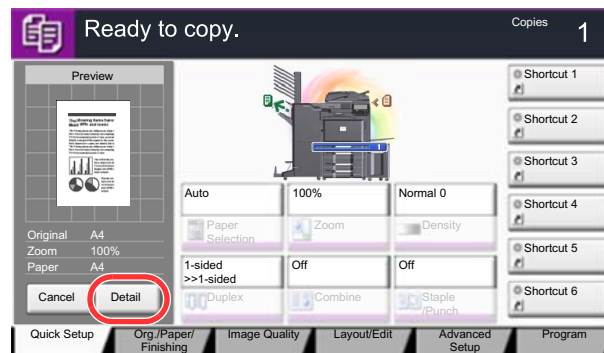

NOTE

To change the quality or the layout, press [Cancel] or the [Stop] key.

Change the settings and press [Preview] again to see a preview image with the new settings.

In magnified view, you can move the range of display.

Zoom out. Zoom in.

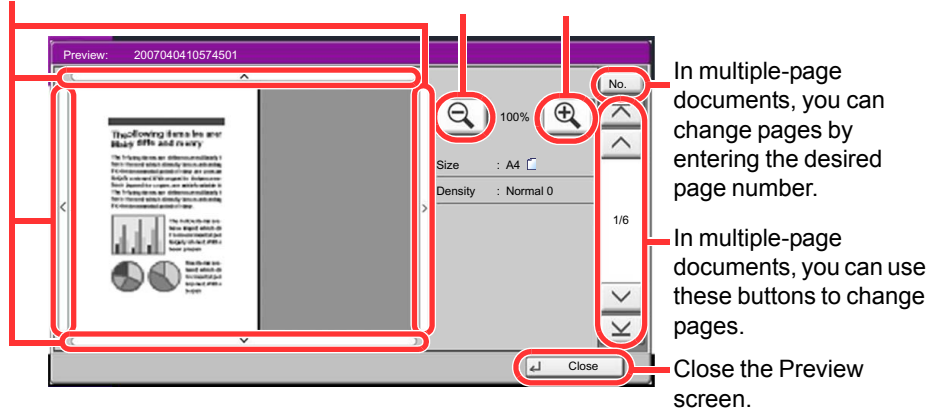

NOTE

Depending on the function you are using, even if you scan a multi-page original, only the first page can be previewed.

- 4 If there is no problem with the preview image, press the [Start] key.
Copying starts.

Using the Preview Screen

When the Preview screen is displayed, you can do the following by moving the finger that is touching the touch panel.

Function	Description
Drag	With the finger touching the touch panel, slide the finger to move the position of the displayed preview.
Pinch in Pinch out	With two fingers touching the touch panel, widen or tighten the space between the two fingers to zoom in and out on the view.

Enter key and Quick No. Search key

This section explains how to use the [Enter] key and [Quick No. Search] key on the operation panel.

Using the [Enter] key ()

The [Enter] key has the same function as the key with the Enter mark (↵), such as the [↵ OK] key and the [↵ Close].

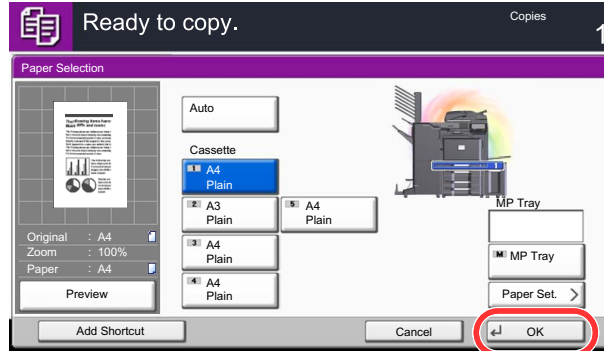

Using the [Quick No. Search] key ()

The [Quick No. Search] key performs the same action as the [No.] displayed on the touch panel. Use the Quick No. Search keys to perform an action by simply entering a number directly using the numeric keys. For example, you can specify the speed dial for a transmission destination or recall a stored program by its program number.

 For more information on speed dialing, refer to [Specifying Destination on page 5-26](#).

Quick No.
Search

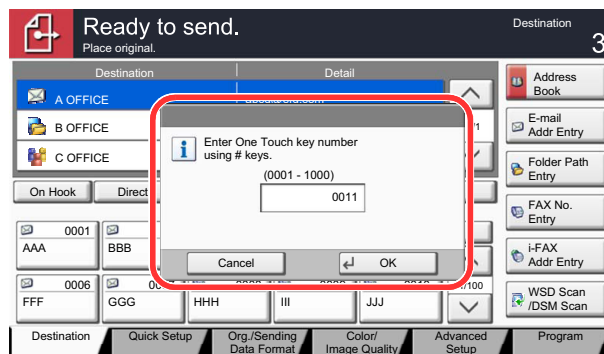

Help Screen

If you have difficulty operating the machine, you can check how to operate it using the touch panel.

To show the Help screen, press the [Help] key on the operation panel. The Help screen shows explanations of functions and how to use them.

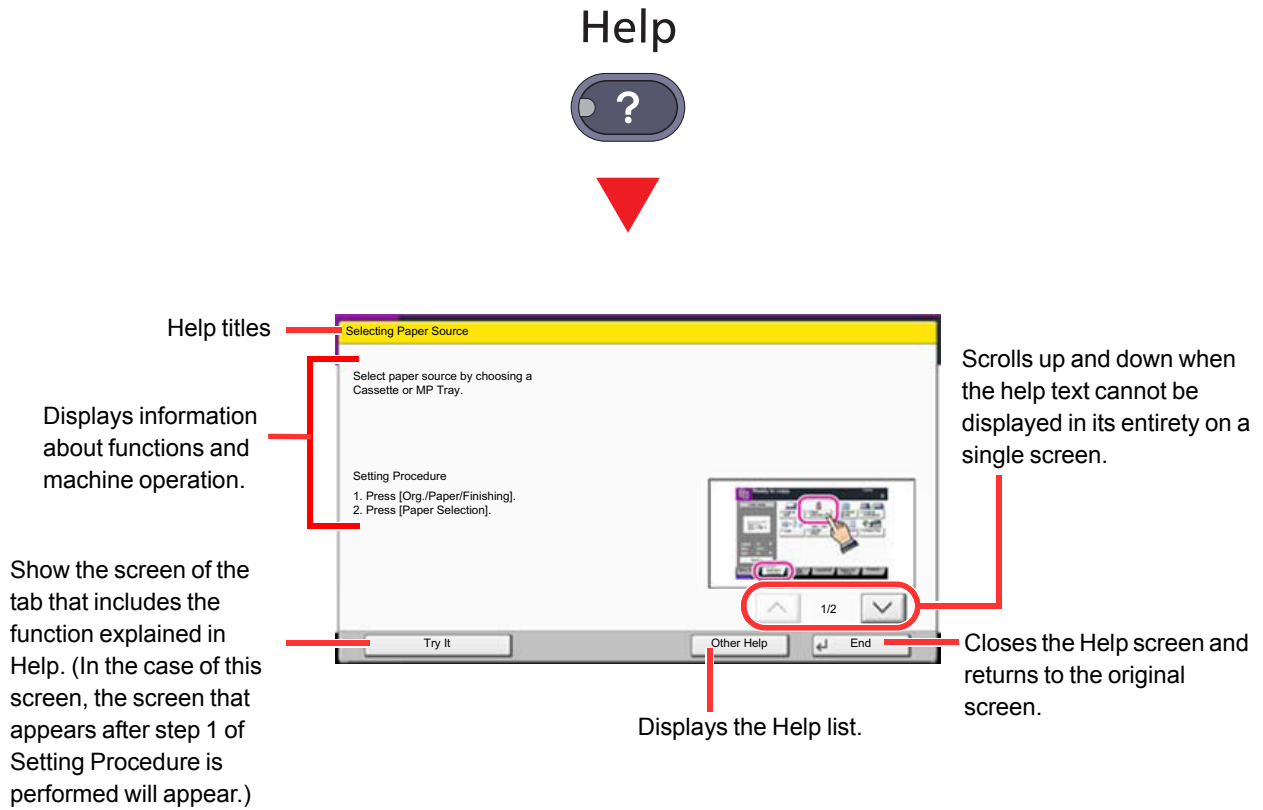

NOTE

To show the Help list, press the [Help] key on the Home screen.

Accessibility Functions (Magnifying the View)

You can magnify the text and keys displayed on the touch panel. You can also select items and move to the next screen using the numeric keys.

NOTE

This function can be used on the Home screen and on the functions that were registered via Copy/Send Quick Setup. To configure any functions that are not displayed on the Accessibility screen, you need to return to the original view. Press the [Accessibility Display] key again.

While using the Copy or Send functions, press the [Accessibility Display] key.

Large keys and text appear on the touch panel.

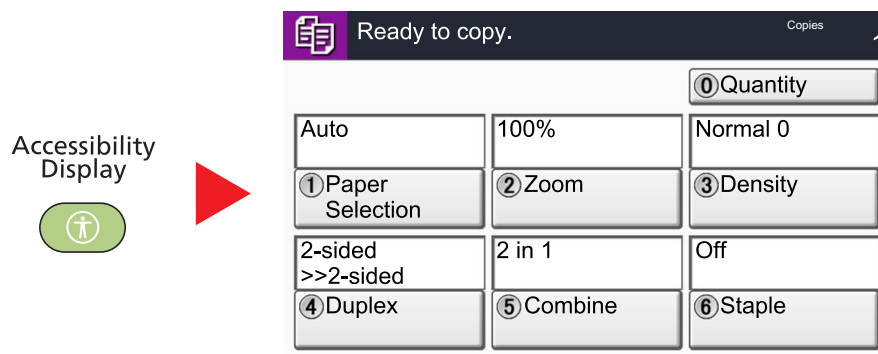

You can also control the screen using the numeric key corresponding to the number in circle. (Example: Press the [2] key on the numeric key pad to zoom.)

Control the functions according to the display on the screen.

Energy Saver function

Low Power Mode and Auto Low Power Mode

Low Power Mode

To activate Low Power Mode, press the [Energy Saver] key. Touch panel and all indicators on the operation panel will go out to save power except the [Energy Saver], [Power], and Main Power indicators. This status is referred to as Low Power Mode.

When the [Power] key is pressed in low power mode, the machine enters the sleep state.

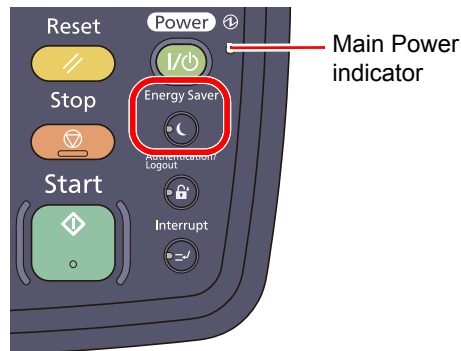

If print data is received during Low Power Mode, the machine automatically wakes up and starts printing. Also when fax data arrives while the machine is in Low Power Mode when using the optional fax, the machine automatically wakes up and starts printing.

To resume, perform one of the following actions.

- Press the touch panel or any key other than the [Power] key.
- Open the platen cover or the optional document processor.
- Place originals in the optional document processor.

The machine will be ready to operate within 30 seconds.

Note that ambient environmental conditions, such as ventilation, may cause the machine to respond more slowly.

Auto Low Power Mode

Auto Low Power Mode automatically switches the machine into Low Power Mode if left idle for a preset time.

The default preset time is 2 minutes.

For information on the Low Power Mode settings, refer to [Low Power Timer on page 8-54](#).

Energy Saver Recovery Level

This machine can reduce power consumption when recovering from Energy Saver Mode.

For EnergySaver RecoveryLevel, "Full Recovery", "Normal Recovery" or "Power Saving Recovery" can be selected. The factory default is "Normal Recovery".

For more information on Energy Saver Mode settings, refer to [EnergySaver RecoveryLevel on page 8-56](#).

Sleep and Auto Sleep

Sleep

To enter Sleep, press the **[Power]** key. Touch panel and all indicators on the operation panel will go out to save a maximum amount of power except the Main Power indicator. This status is referred to as Sleep.

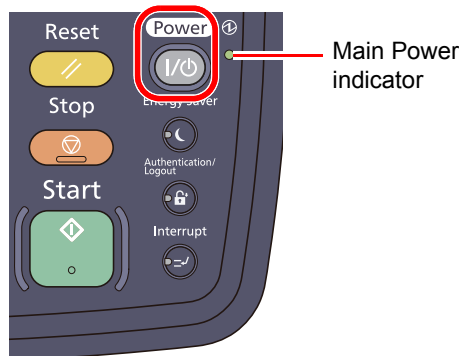

If print data is received during Sleep, the print job is performed while the touch panel remains unlit. When using the optional fax, received fax data is printed out while the operation panel also remains unlit.

- Press the touch panel or any key on the operation panel.

The machine will be ready to operate within 16 seconds.

Note that ambient environmental conditions, such as ventilation, may cause the machine to respond more slowly.

Auto Sleep

Auto Sleep automatically switches the machine into Sleep if left idle for a preset time in the Low Power Mode.

The default preset time are 45 minutes for 3501i, and 60 minutes for 4501i/5501i.

To change the preset sleep time, refer to [Sleep Timer on page 8-55](#).

Sleep Rules (models for Europe)

You can set whether sleep mode operates for each function. When the machine enters sleep mode, it cannot perform printing from a computer connected by USB cable. In addition, it takes longer for the machine to wake and return to normal operation. Also, the ID card cannot be recognized.



For more information on Sleep Rules settings, refer to [Sleep Rules \(models for Europe\) on page 8-55](#).

Sleep Level (Energy Saver) (models except for Europe)

This mode reduces power consumption even more than normal Sleep mode, and allows Sleep Mode to be set separately for each function. Printing from a computer connected with a USB cable is not available while the machine is asleep. The time required for the machine to wake up from power save mode and resume normal operation will be longer than for normal Sleep Mode.



NOTE

If the optional network interface kit is installed, Energy Saver cannot be specified.



For more information on Energy Saver Mode settings, refer to [Sleep Level \(models except for Europe\) on page 8-56](#).

Energy Saver Recovery Level

This machine can reduce power consumption when recovering from Energy Saver Mode.

For EnergySaver RecoveryLevel, "Full Recovery", "Normal Recovery" or "Power Saving Recovery" can be selected. The factory default is "Normal Recovery".

For more information on Energy Saver Mode settings, refer to [EnergySaver RecoveryLevel on page 8-56](#).

Loading Paper

Load paper in the cassettes and multipurpose tray.

For the paper load methods for each cassette, refer to the page below.

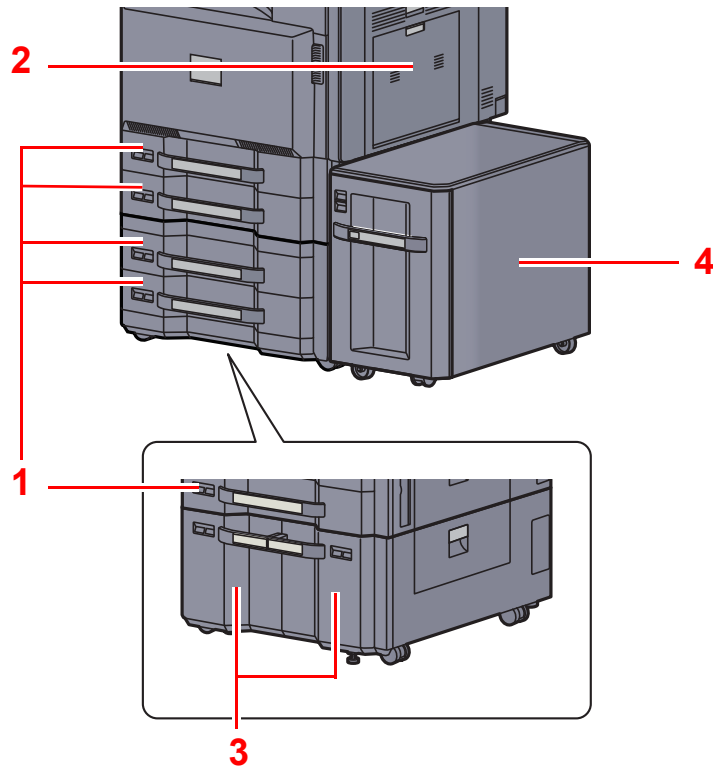

Cassettes		Name	No.	Page
Standard	Cassette 1, Cassette 2	Standard cassettes	1	page 3-18
	Multi Purpose Tray	Multi Purpose Tray	2	page 3-26
Option	Cassette 3, Cassette 4	Side Feeder (500-sheet x 2)*	1	page 3-18
		Large Capacity Feeder (1,500-sheet x 2)	3	page 3-21
	Cassette 5	Side Feeder (3,000-sheet)	4	page 3-25

* The paper feed method is the same as standard cassettes.

NOTE
 The number of sheets that can be held varies depending on your environment and paper type. You should not use inkjet printer paper or any paper with a special surface coating. (Such paper may cause paper jams or other faults.)

Before Loading Paper

When you open a new package of paper, fan the sheets to separate them slightly prior to loading in the following steps.

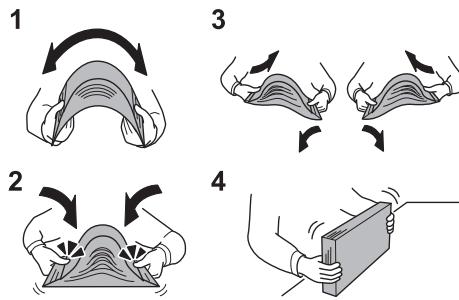

- 1 Bend the whole set of sheets to swell them in the middle.
- 2 Hold the stack at both ends and stretch it while keeping the entire stack swelled.
- 3 Raise the right and left hands alternately to create a gap and feed air between the papers.
- 4 Finally, align the papers on a level, flat table.

If the paper is curled or folded, straighten it before loading. Paper that is curled or folded may cause a jam.

✔ IMPORTANT

If you copy onto used paper (paper already used for printing), do not use paper that is stapled or clipped together. This may damage the machine or cause poor image quality.

👁 NOTE

Note that some paper types have a tendency to curl and may jam in the paper eject unit. If you use special paper such as letterhead, paper with holes or paper with pre-prints like logo or company name, refer to [Paper on page 11-13](#).

Avoid exposing opened paper to high temperatures and high humidity as dampness can be a cause of problems. Seal any remaining paper after loading in the multi purpose tray or cassettes back in the paper storage bag.

If the machine will not be used for a prolonged period, protect all paper from humidity by removing it from the cassettes and sealing it in the paper storage bag.

Loading in the Cassettes

Standard cassettes

The standard cassettes can hold plain paper, recycled paper or color paper.

The cassettes hold up to 500 sheets of plain paper (80 g/m²) (or up to 550 sheets of 64 g/m² plain paper).

The following paper sizes are supported: A3, B4, A4, A4-R, B5, B5-R, A5-R, Folio, Ledger, Legal, Oficio II, 12 x 18", Letter, Letter-R, Statement-R, 8K, 16K, 16K-R, and 216 x 340 mm, Custom (140 x 182 mm - 304 x 457 mm).

✔ IMPORTANT

When using media types other than plain paper (such as recycled or colored paper), always specify the media type and paper weight settings.

 [Specifying Paper Size and Media Type for the Cassettes \(page 3-31\)](#)
[Media Type Setting \(page 8-13\)](#)

The cassettes can hold paper with weight between 60 - 220 g/m². If you are using a paper weight of 106 g/m² or more, set the media type to Thick and set the weight of the paper you are using.

Do not load thick paper that is heavier than 256 g/m² in the cassettes. Use the multi purpose tray for paper that is heavier than 256 g/m².

If you wish to use 330 x 210 mm to 356 x 220 mm paper, contact a service technician.

1 Pull the cassette out toward you until it stops.

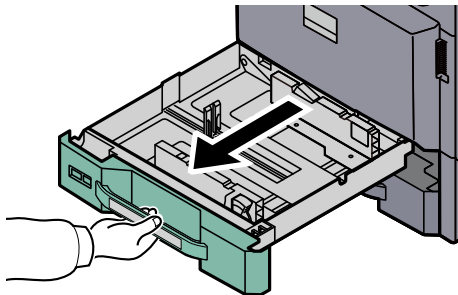

NOTE

Do not pull out more than one cassette at a time.

2 Adjust the cassette size.

- 1 Squeeze the ends of the bottom of the paper length guide and move the guide to fit the length of the paper.

Paper sizes are marked on the cassette.

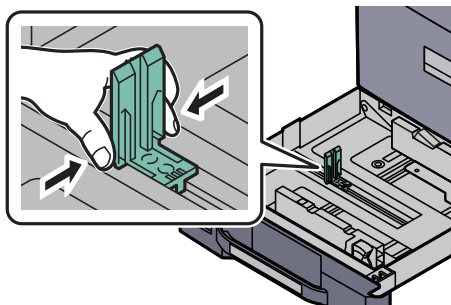

- 2 Press the (Paper Width Guide) Lock to release the lock. Grasp the paper width adjusting tab and move the paper width guides to fit the paper.

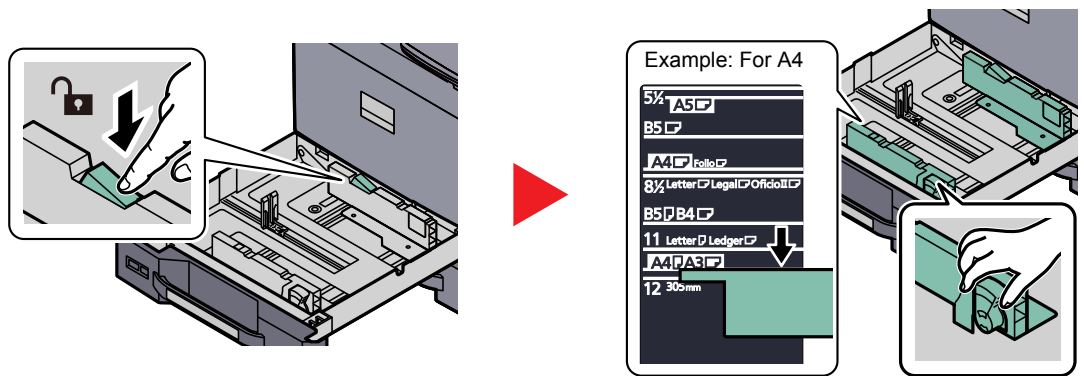

3 Load paper.

- 1 Align the paper flush against the right side of the cassette.

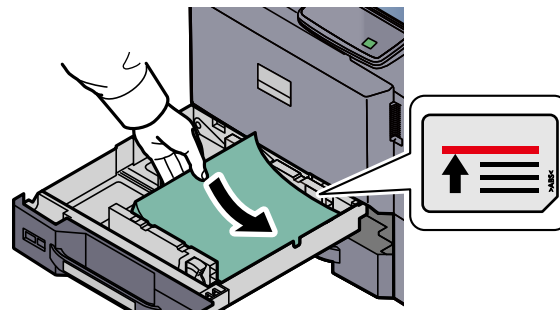

✓ IMPORTANT

- If paper is loaded without adjusting the paper length guide and paper width guide, the paper may skew or become jammed.
- Load the paper with the print side facing up.
- After removing new paper from its packaging, fan the paper before loading it in the multi-purpose tray. (Refer to [Before Loading Paper on page 3-17.](#))
- Before loading the paper, be sure that it is not curled or folded. Paper that is curled or folded may cause paper jams.
- Ensure that the loaded paper does not exceed the level indicator (see illustration below).

- 2 Be sure that the paper length and width guides rest securely against the paper. If there is a gap, readjust the guides to fit the paper.

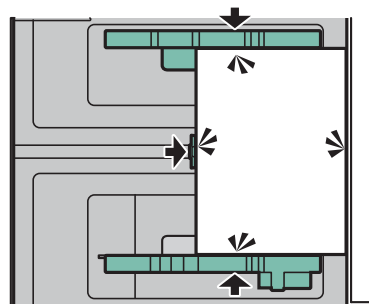

- 3 Press the (Paper Width Guide) Lock to lock.

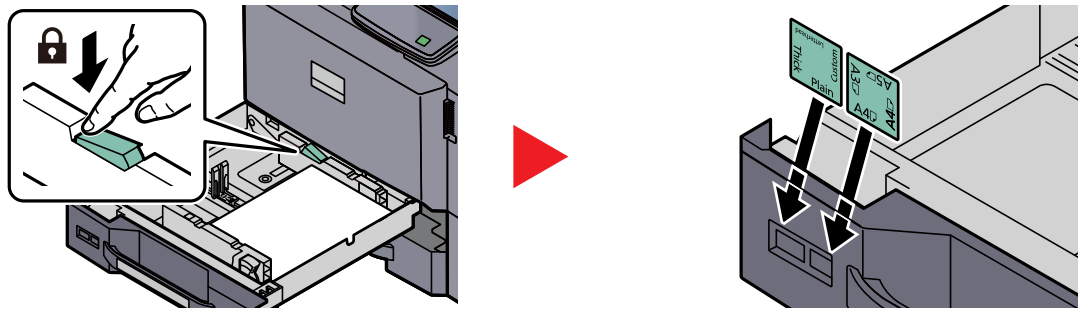

4 Gently push the cassette back in.



NOTE

- If the machine will not be used for a prolonged period, protect all paper from humidity by removing it from the cassettes and sealing it in the paper storage bag.
- Select the media type (plain, recycled, etc.) loaded in the cassette.



[Specifying Paper Size and Media Type for the Cassettes \(page 3-31\)](#)

The Large Capacity Feeder (1,500-sheet x 2) (Option)

The Optional cassettes will each hold plain paper, recycled paper or color paper.

The Large Capacity Feeder (1,500-sheet x 2) holds up to 3,000 sheets (1,500-sheet x 2) of plain paper (80 g/m²) (or up to 3,500 sheets (1,750-sheet x 2) of 64 g/m² plain paper).

The following paper sizes are supported: A4, B5 and Letter.

✔ IMPORTANT

When using media types other than plain paper (such as recycled or colored paper), always specify the media type and paper weight settings.

 [Specifying Paper Size and Media Type for the Cassettes \(page 3-31\)](#)
[Media Type Setting \(page 8-10\)](#)

The cassettes can hold paper with weights up to 256 g/m². If you are using a paper weight of 106 g/m² or more, set the media type to Thick and set the weight of the paper you are using.

Do not load thick paper that is heavier than 256 g/m² in the cassettes. Use the multi purpose tray for paper that is heavier than 256 g/m².

1 Pull the cassette out toward you until it stops.

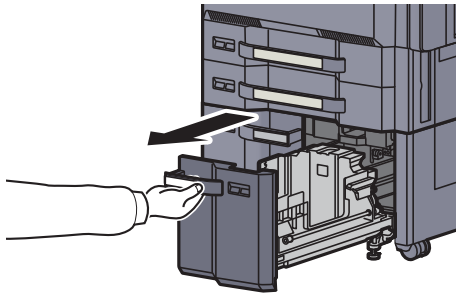

2 Adjust the cassette size.

- 1 Rotate the Paper Size Guide (A) clamp and remove. Pull the Paper Size Guide (A) up and out.

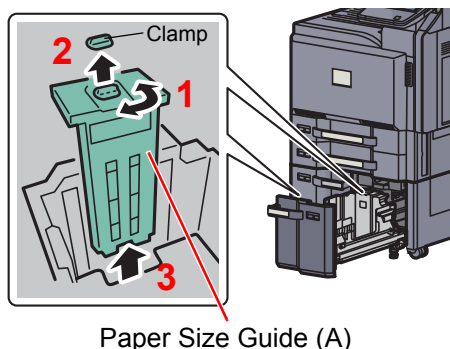

- 2 Insert the Paper Size Guide (A) into the slot (bottom of cassette) for the paper size to be used.

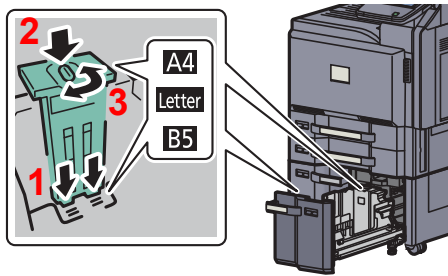

Make sure that the top of the paper size guide (A) matches the paper size to be used, attach the clamp, and rotate the clamp to lock it.

Gently try moving the Paper Size Guide (A) to verify that it is fixed.

- 3 With the bottom of the cassette pressed all the way down, press the hook on the side of the Paper Size Guide (B) to release it and pull out the Paper Size Guide (B).

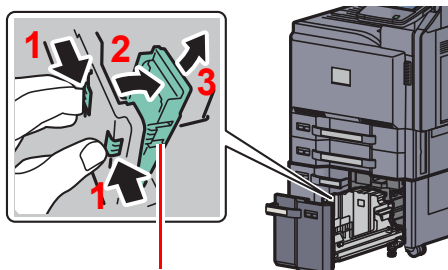

Paper Size Guide (B)

- 4 Adjust the Paper Size Guide (B) to the paper size.

A4

Insert the Paper Size Guide (B) into the slot marked A4 (on the bottom of the cassette), and lock the hook (it will make a "click" sound).

Gently try moving the Paper Size Guide (B) to verify that it is fixed.

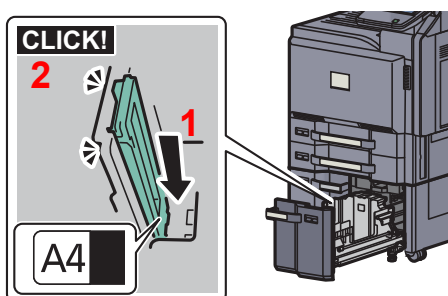

B5

Open the Paper Size Guide (B) as shown, insert into the slot marked B5 (on the bottom of the cassette), and lock the hook (it will make a "click" sound).

Gently try moving the Paper Size Guide (B) to verify that it is fixed.

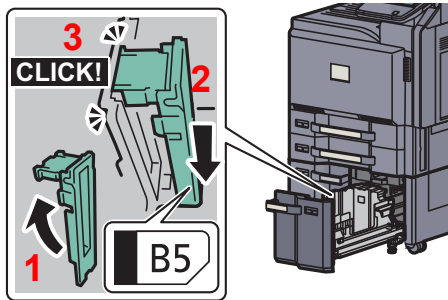

Letter

The Paper Size Guide (B) is not attached.

With the bottom of the cassette pressed all the way down, press the hook on the side of the Paper Size Guide (C) to release it and pull out the Paper Size Guide (C).

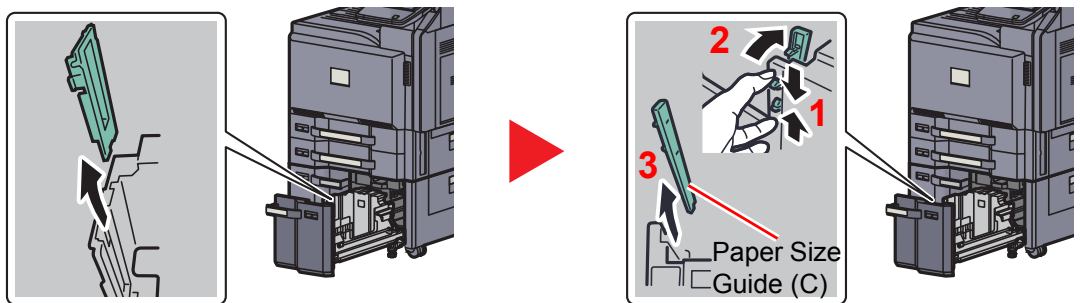

3 Load paper.

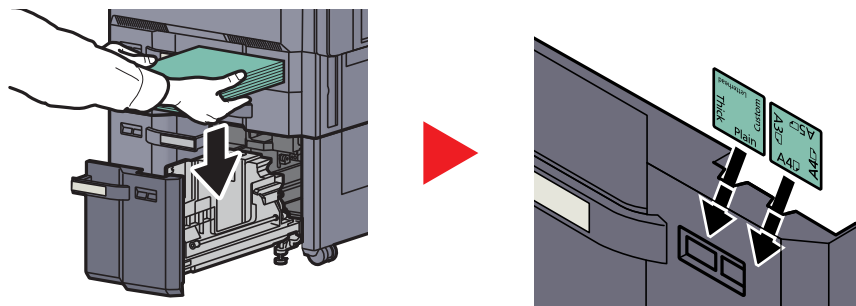

✔ **IMPORTANT**

- Load the paper with the print side facing up.
- After removing new paper from its packaging, fan the paper before loading it in the multi-purpose tray.

🔍 [Before Loading Paper \(page 3-17\)](#)

- Before loading the paper, be sure that it is not curled or folded. Paper that is curled or folded may cause paper jams.
- Ensure that the loaded paper does not exceed the level indicator (see illustration below).

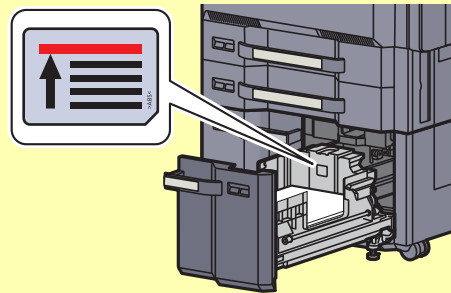

4 Gently push the cassette back in.

💡 **NOTE**

- If the machine will not be used for a prolonged period, protect all paper from humidity by removing it from the cassettes and sealing it in the paper storage bag.
- Select the media type (plain, recycled, etc.) loaded in the cassette.

🔍 [Specifying Paper Size and Media Type for the Cassettes \(page 3-31\)](#)

Side Feeder (3,000-sheet) (Option)

The side feeder hold up to 3,000 sheets of plain paper (80 g/m²).

The following paper sizes are supported: A4, B5 and Letter.

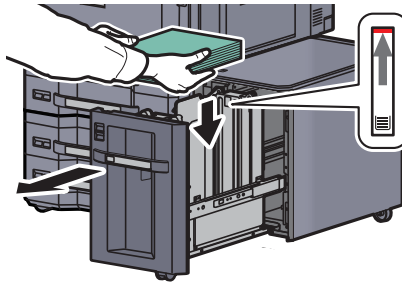

Pull the cassette out toward you until it stops and insert the paper into the cassette. After loading paper, gently push the cassette back in.



NOTE

The default paper size setting is A4. If you need the paper size changed to B5 or Letter, contact your service representative.



IMPORTANT

- **When loading the paper, keep the print side facing down.**
- **Before loading the paper, be sure that it is not curled or folded. Paper that is curled or folded may cause paper jams.**
- **Ensure that the loaded paper does not exceed the level indicator (see illustration above).**

Loading Paper in the Multi Purpose Tray

The multi purpose tray will hold up to 150 sheets of A4 or smaller plain paper (80 g/m²) (or up to 165 sheets of 64 g/m² plain paper) or up to 50 sheets of plain paper (80 g/m²) (or up to 55 sheets of 64 g/m² plain paper) larger than A4.

The multi purpose tray accepts paper sizes from A3 to A6-R and Hagaki and from Ledger to Statement-R, 12 x 18", 8K, 16K and 16K-R. Be sure to use the multi purpose tray when you print on any special paper.

✔ IMPORTANT

When using media types other than plain paper (such as recycled or colored paper), always specify the media type and paper weight settings.

 [Specifying Paper Size and Media Type for the Multi Purpose Tray \(MP Tray Setting\) \(page 3-34\)](#)
[Media Type Setting \(page 8-13\)](#)

If you are using a paper weight of 106 g/m² or more, set the media type to Thick and set the weight of the paper you are using.

The capacity of the multi purpose tray is as follows.

- A4 or smaller plain paper (80 g/m²), recycled paper or color paper: 150 sheets (64 g/m² plain paper : 165 sheets)
- B4 or larger plain paper (80 g/m²), recycled paper or color paper: 50 sheets (64 g/m² plain paper : 55 sheets)
- Hagaki: 30 sheets
- OHP film: 10 sheets
- Envelope DL, Envelope C4, Envelope C5, Envelope #10 (Commercial #10), Envelope #9 (Commercial #9), Envelope #6 (Commercial #6), Monarch, Youkei 4, Youkei 2: 10 sheets
- Banner paper: 470.1 mm (18.51") to a maximum of 1220.0 mm (48"): 1 sheet (manual feed), 10 sheets (when optional banner tray is attached)

NOTE

When you load custom size paper, enter the paper size by referring to [Specifying Paper Size and Media Type for the Multi Purpose Tray \(MP Tray Setting\) on page 3-34](#).

When you use special paper such as transparencies or thick paper, select the media type by referring to [Specifying Paper Size and Media Type for the Multi Purpose Tray \(MP Tray Setting\) on page 3-34](#).

1 Open the multi purpose tray.

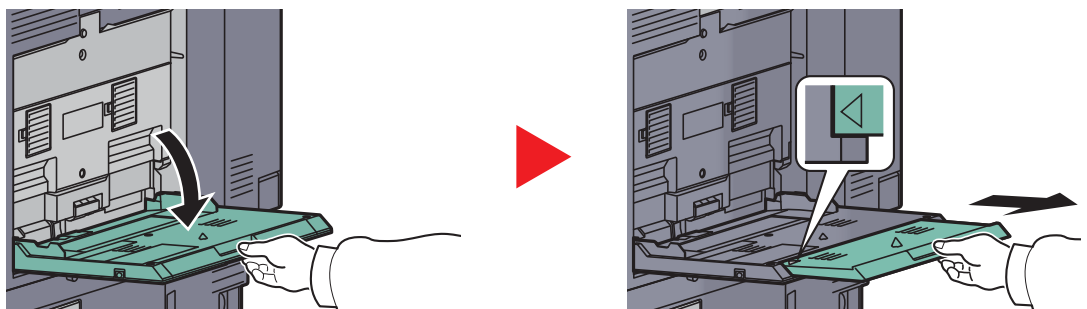

When loading paper sizes 12 x 18" and from A3 to B4 and Ledger to Legal, extend the support tray section of the multi purpose tray until the "Δ" mark is fully appeared.

2 Adjust the multi purpose tray size.

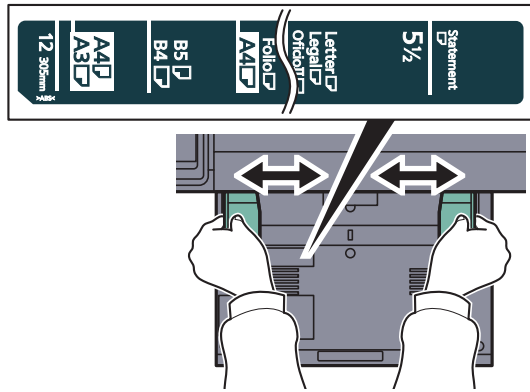

3 Load paper.

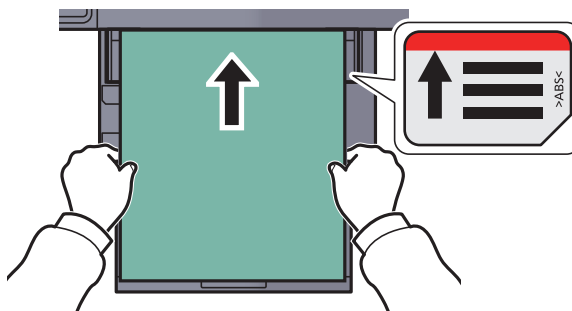

Insert the paper along the paper width guides into the tray until it stops.

After removing new paper from its packaging, fan the paper before loading it in the multi-purpose tray.

 [Before Loading Paper \(page 3-17\)](#)

IMPORTANT

- When loading the paper, keep the print side facing down.
- Curled paper must be uncurled before use.
- Straighten the top edge if it is curled.
- When loading paper into the multi purpose tray, check that there is no paper left over in the tray from a previous job before loading the paper. If there is just a small amount of paper left over in the multi purpose tray and you want to add more, first remove the left-over paper from the tray and include it with the new paper before loading the paper back into the tray.
- If there is a gap between the paper and the paper width guides, readjust the guides to fit the paper in order to prevent skewed feeding and paper jams.
- Ensure that the loaded paper does not exceed the level indicator (see illustration above).

When you load envelopes or cardstock in the multi purpose tray

Load the paper with the print side facing down. For the procedure for printing, refer to the **Printer Driver User Guide**.

Example: When printing the address.

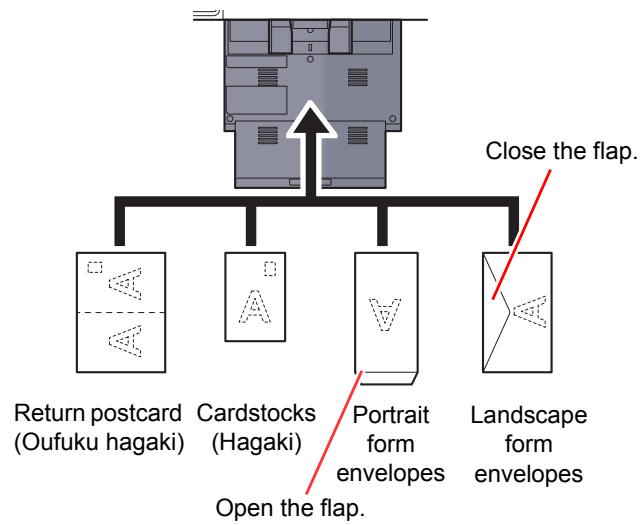

✔ IMPORTANT

- Use unfolded return postcard (Oufuku hagaki).
- How to load envelopes (orientation and facing) will differ depending on the type of envelope. Be sure to load it in correctly, otherwise printing may be done in the wrong direction or on the wrong face.

📄 NOTE

When you load envelopes in the multi purpose tray, select the envelope type by referring to [Specifying Paper Size and Media Type for the Multi Purpose Tray \(MP Tray Setting\)](#) on page 3-34.

When you load index paper in the multi purpose tray

1 Prepare paper.

Sort the pages so that the 1st page is at the back.

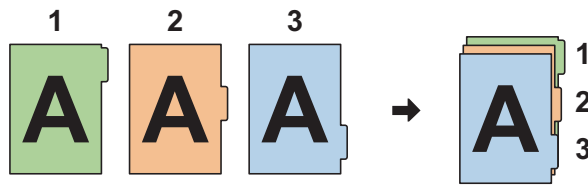

2 Orient the paper in the same orientation.

Place the paper print side down, oriented so that the tabs are on the trailing side of the paper when it feeds in.

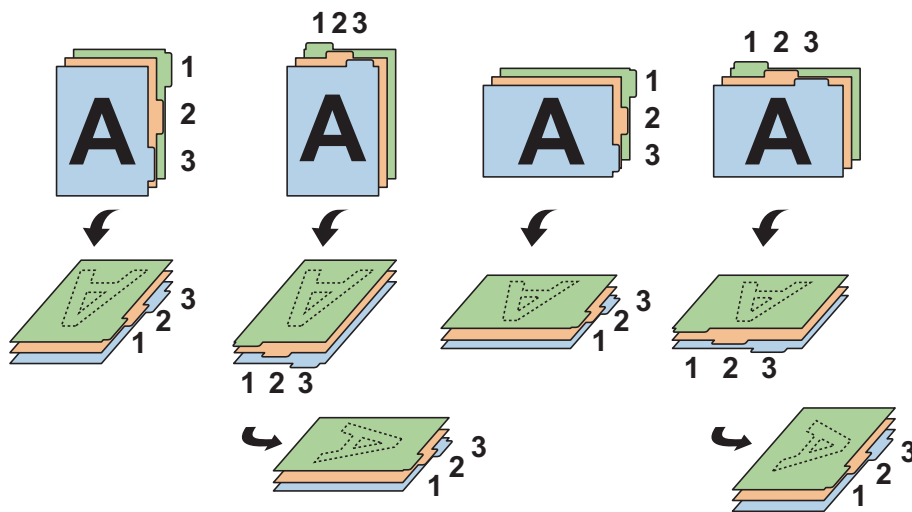

3 Load paper.

Load paper in the tray.

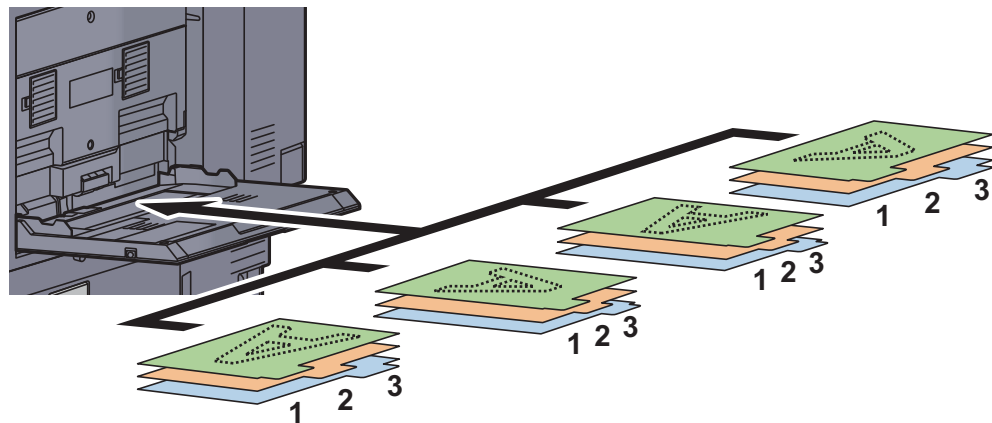

For the procedure for printing, refer to the **Printer Driver User Guide**.
Index paper must meet the following conditions.

Item	Description
Paper size	A4/Letter
Paper weight	136 to 256 g/m ²
Number of tabs	1 to 15
Length of tabs	30 mm or less

Paper stopper

To use the sheet ejection stopper, open as shown below. (Example: A3, B4, Ledger, Legal)

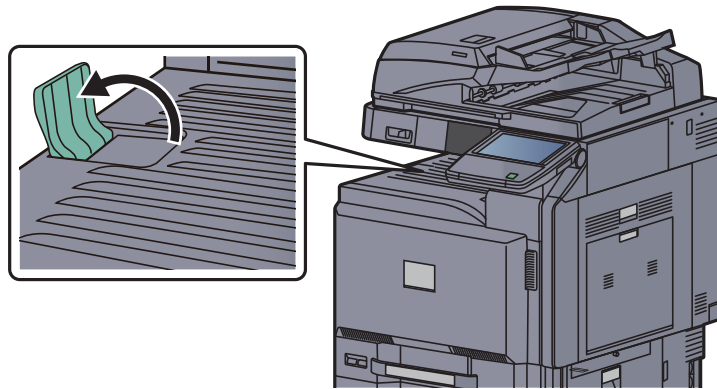

Specifying Paper Size and Media

The default paper size setting for cassettes 1 and 2, for the multi purpose tray and for the optional paper feeder (cassettes 3 to 5) is "Auto", and the default media type setting is "Plain".

To fix the type of paper to be used in cassettes, specify the paper size and media type setting. (Refer to [Specifying Paper Size and Media Type for the Cassettes on page 3-31](#).) To fix the type of paper to be used in multi purpose tray, specify the paper size setting. (Refer to [Specifying Paper Size and Media Type for the Multi Purpose Tray \(MP Tray Setting\) on page 3-34](#).)

Specifying Paper Size and Media Type for the Cassettes

If a fixed size of paper will be used, set the paper size.

Selection Item		Selectable Size/Type
Paper Size	Auto	Paper size is automatically detected and selected. Values: Metric, Inch
	Standard Sizes 1* ¹	Available options are as follows: Values: Metric models: A3, A4, A4-R, A5-R, B4, B5, B5-R, Folio, 216 x 340 mm Inch models: Ledger, Letter, Letter-R, Legal, Statement, 12 x 18", Oficio II
	Standard Sizes 2* ¹	Select from standard size except Standard Sizes 1. Values: Metric models: Ledger, Letter, Letter-R, Legal, Statement, 12 x 18", Oficio II, 8K, 16K, 16K-R Inch models: A3, A4, A4-R, A5-R, B4, B5, B5-R, Folio, 216x340 mm, 8K, 16K, 16K-R
	Size Entry* ²	Enter a size not displayed in the standard sizes. Values: Metric X : 182 to 457 mm (in 1 mm increments), Y : 140 to 304 mm (in 1 mm increments), Inch X : 7.17 to 18.00" (in 0.01" increments) Y : 5.51 to 12.00" (in 0.01" increments)
Media type		Select the media type. Values: Plain (60 - 105 g/m ²), Rough, Vellum (60 - 105 g/m ²), Recycled, Preprinted* ³ , Bond* ³ , Color, Prepunched* ³ , Letterhead* ⁴ , Thick (106g/m ² or more)* ⁴ , High Quality, Custom 1 - 8* ⁴

*1 Only A4, Letter, and B5 can be specified when the optional Large Capacity Feeder (1,500-sheet x 2) is used.

*2 Can be set when cassette 1 or cassette 2 is selected.

*3 To print on preprinted or prepunched paper or on letterhead, refer to [Special Paper Action on page 8-12](#).

*4 To change to a media type other than Plain, refer to [Media Type Setting on page 8-10](#). When the paper weight settings shown below are selected, the media indicated for each setting cannot be selected.

Rough: "Heavy 4" or "Heavy 5"

Preprinted: "Heavy 4" or "Heavy 5"

Letterhead: "Heavy 4" or "Heavy 5"

Thick: "Heavy 4" or "Heavy 5"

Bond: "Heavy 4"

Custom 1 to 8: "Heavy 4", "Heavy 5", or "Extra Heavy"

NOTE

If the optional FAX Kit is installed, the available media types for printing received faxes are as shown below.
 Plain, Recycled, Bond, Vellum, Color, Thick, High Quality, Rough and Custom 1 to 8
 Set the paper size of the cassette used for fax reception as follows:
 Inch models: Press [Auto] and then [Inch].
 Metric models: Press [Auto] and then [Metric].
 If the above setting is changed, it will not be possible to print faxes.

1 Display the screen.

- 1 Press the [System Menu] key.

System Menu



- 2 Press [Cassette/MP Tray Settings].

2 Configure the settings.

- 1 In "Cassette Setting", select one of [Cassette 1] - [Cassette 5], and press [Next]. Then in "Paper Size", press [Change].
- 2 For automatic detection of the paper size, press [Auto] and select [Metric] or [Inch] as the unit.
 To select the paper size, press [Standard Sizes 1] or [Standard Sizes 2] and select the paper size.

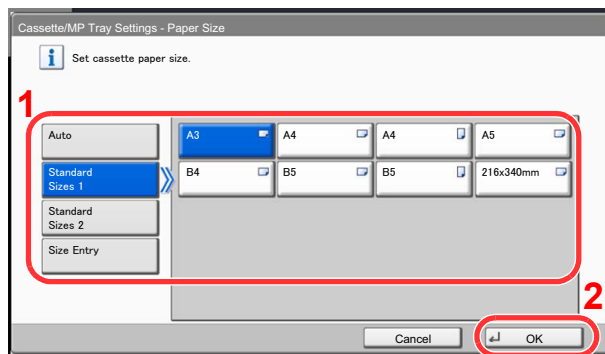

When cassette 1 or 2 is selected, a size not displayed in the standard sizes can be set.

Select [Size Entry], press [+], [-] to enter "X" (horizontal) and "Y" (vertical) dimensions. By pressing [# Keys], you can use the numeric keys.

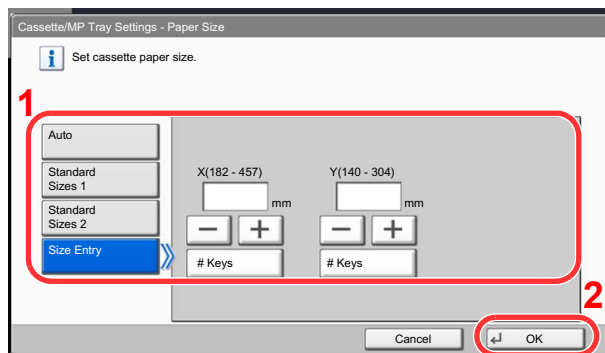

NOTE

[Cassette 3] to [Cassette 5] are shown when the optional paper feeder is installed.

3 Press [OK].

The previous screen reappears.

4 Press [Change] of "Media Type" to select the media type and press [OK].

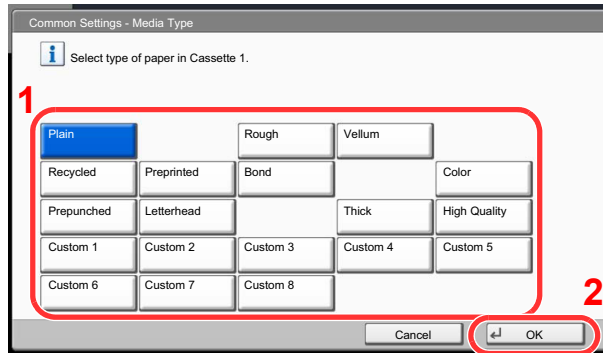

Specifying Paper Size and Media Type for the Multi Purpose Tray (MP Tray Setting)

To fix the type of paper to be used in the multi purpose tray, specify the paper size. When using other than a plain paper, specify the media type.

Item		Description
Paper Size	Auto	Paper size is automatically detected and selected. Values: Metric, Inch
	Standard Sizes 1	Available options are as follows: Values: Metric models: A3, A4, A4-R, A5-R, A6-R, B4, B5, B5-R, B6-R, Folio, 216 x 340 mm Inch models: Ledger, Letter, Letter-R, Legal, Statement, Executive, 12x18", Oficio II
	Standard Sizes 2	Select from the standard sizes* ¹ not included in Standard Sizes 1. Values: Metric models: Ledger, Letter, Letter-R, Legal, Statement, Executive, 12 x 18", Oficio II, 8K, 16K, 16K-R Inch models: A3, A4, A4-R, A5-R, A6-R, B4, B5, B5-R, B6-R, Folio, 8K, 16K, 16K-R, 216 x 340 mm
	Others	Select from special standard sizes and custom sizes. Values: ISO B5, Envelope #10, Envelope #9, Envelope #6, Envelope Monarch, Envelope DL, Envelope C5, Envelope C4, Hagaki, Oufuku hagaki, Youkei4, Youkei2
	Size Entry	Enter a size not displayed in the standard sizes. Value Metric X : 148 to 457 mm (in 1 mm increments) Y : 98 to 304 mm (in 1 mm increments) Inch X : 5.83 to 18.00" (in 0.01" increments) Y : 3.86 to 12.00" (in 0.01" increments)
Media Type		Select the media type. Values: Plain (60 - 105 g/m ²), Rough, Transparency, Vellum (60 - 105 g/m ²), Labels, Recycled, Preprinted* ² , Bond, Cardstock, Color, Prepunched* ² , Letterhead* ² , Envelope, Thick (106 g/m ² or more), Coated, High Quality, Index Tab Dividers* ³ , Custom 1-8

*1 To change to a media type other than "Plain", refer to [Media Type Setting on page 8-10](#).

*2 To print on preprinted or prepunched paper or on letterhead, refer to [Special Paper Action on page 8-12](#).

*3 If you print from the printer driver, you can enter text on the tab. For details, refer to the **Printer Driver User Guide**.

NOTE

If the optional FAX Kit is installed, the available media types for printing received faxes are as shown below.
Plain, Labels, Recycled, Bond, Vellum, Color, Coated, Cardstock, Envelope, Thick, High Quality, Rough and Custom 1 to 8

1 Display the screen.

- 1 Press the [System Menu] key.

System Menu



- 2 Press [Cassette/MP Tray Settings], [Next] of "MP Tray Setting", and then [Change] of "Paper Size".

2 Configure the settings.

- 1 For automatic detection of the paper size, press [Auto] and select [Metric] or [Inch] as the unit.

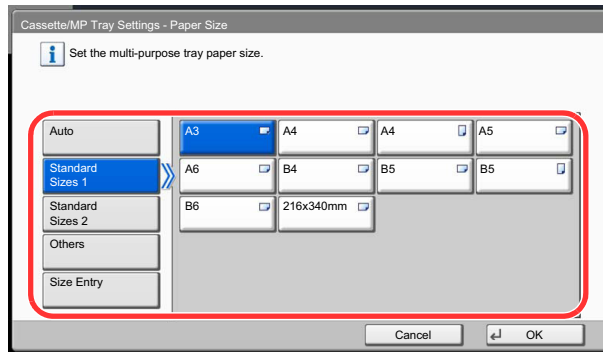

To select the paper size, press [Standard Sizes 1], [Standard Sizes 2], [Others] or [Size Entry] and select the paper size.

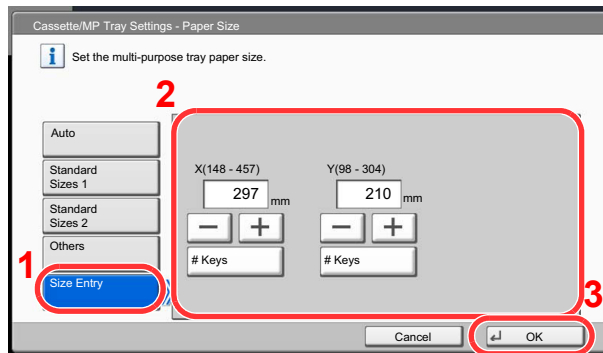

If you select [Size Entry], press [+], [-] to enter "X" (horizontal) and "Y" (vertical) dimensions. By pressing [# Keys], you can use the numeric keys.

- 2 Press [OK].

The previous screen reappears.

- 3 Press [Change] of "Media Type" to select the media type and press [OK].

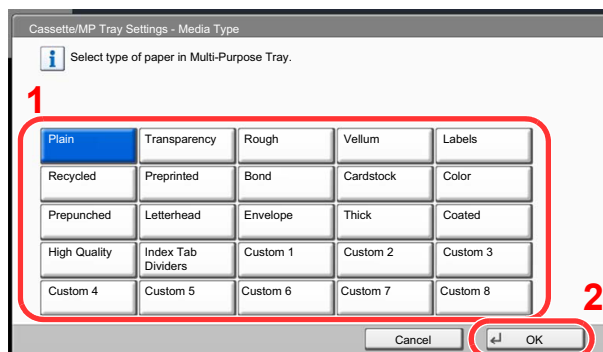

Preparation for Sending a Document to a PC

Check the information that needs to be set on the machine and create a folder to receive the document on your computer. Screens of Windows 7 are used in the following explanation. The details of the screens will vary in other versions of Windows.



NOTE

Log on to Windows with administrator privileges.

Making a note of the computer name and full computer name

Check the name of the computer name and full computer name.

1 Display the screen.

From [Start] button on the Windows, select [Computer] and then [System Properties].

In Windows XP, right-click [My Computer] and select [Properties]. The [System Properties] dialog box appears. Click the [Computer Name] tab in the window that appears.

In Windows 8, select the desktop in the Start screen, right-click [Computer] from [Libraries], and then select [Properties].

2 Check the computer name.

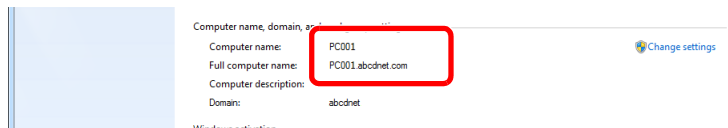

Check the computer name and full computer name.

Screen example:

Computer name: PC001

Full computer name: PC001.abcdnet.com

Windows XP:

If the full computer name does not have a dot (.), the full computer name and the computer name are the same.

If the full computer name has a dot (.), the text string in front of the dot (.) in the full computer name is the computer name.

Example: PC001.abcdnet.com
PC001 is the computer name
PC001.abcdnet.com is the full computer name

After checking the computer name, click the  [Close] button to close the "System Properties" screen.

In Windows XP, after checking the computer name, click the [Cancel] button to close the "System Properties" screen.

Making a note of the user name and domain name

Check the domain name and user name for logging onto Windows.

1 Display the screen.

From [Start] button on the Windows, select [All Programs] (or [Programs]), [Accessories] and then [Command Prompt].

In Windows 8, display [Apps] on [Search] in charms on the Start screen, and select [Command Prompt].

The Command Prompt window appears.

2 Check the domain name and user name.

At the Command Prompt, enter "net config workstation" and then press [Enter].

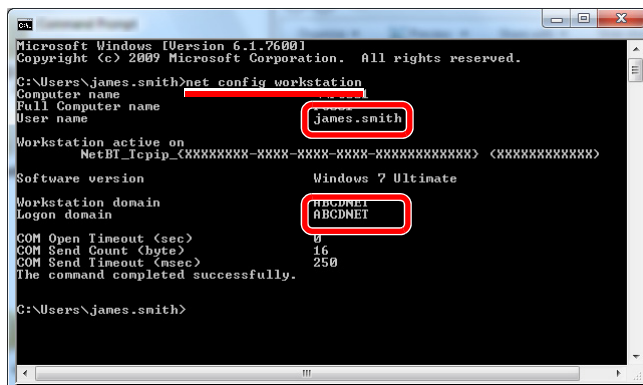

```
Microsoft Windows [Version 6.1.7600]
Copyright (c) 2009 Microsoft Corporation. All rights reserved.

C:\Users\james.smith>net config workstation
Computer name
Full Computer name
User name                james.smith
Workstation active on
NetBI_Tcpip_<XXXXXXXX-XXXX-XXXX-XXXX-XXXXXXXXXXXX> <XXXXXXXXXXXX>
Software version        Windows 7 Ultimate
Workstation domain
Logon domain            ABCDNET
COM Open Timeout (sec)  0
COM Send Count (byte)   16
COM Send Timeout (msec) 250
The command completed successfully.

C:\Users\james.smith>
```

Check the user name and domain name.

Screen example:

User Name: james.smith
Domain Name: ABCDNET

Creating a Shared Folder, Making a Note of a Shared Folder

Create a shared folder to receive the document in the destination computer.

NOTE

If there is a workgroup in System Properties, configure the settings below to limit folder access to a specific user or group.

- 1 From **[Start]** button on the Windows, select **[Control Panel]**, **[Appearance and Personalization]**, and then **[Folder Options]**.

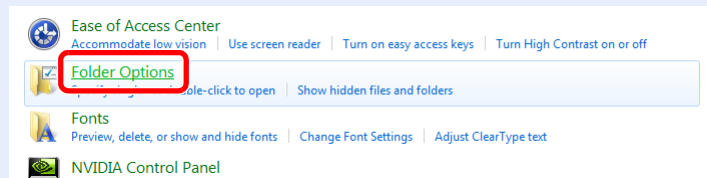

In Windows XP, click **[My Computer]** and select **[Folder Options]** in **[Tools]**.

In Windows 8, select **[Settings]** in charms on Desktop, and select **[Control Panel]**, **[Appearance and Personalization]**, and then **[Folder Options]**.

- 2

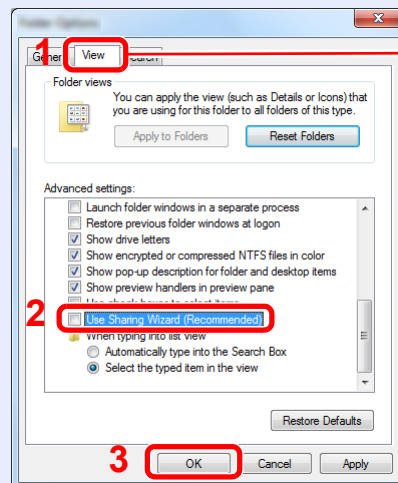

Make sure that the **[View]** tab is selected.

Remove the checkmark from **[Use Sharing Wizard (Recommended)]** in "Advanced settings".

In Windows XP, click the **[View]** tab and remove the checkmark from **[Use Simple File Sharing (Recommended)]** in "Advanced settings".

1 Create a folder.

- 1 Create a folder on your computer.

For example, create a folder with the name "scannerdata" on the desktop.

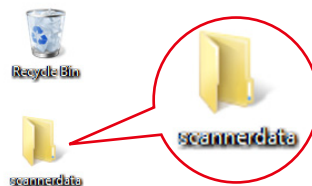

- 2 Right-click the "scannerdata" folder and click **[Share]** and **[Advanced sharing]**. Click the **[Advanced Sharing]** button.

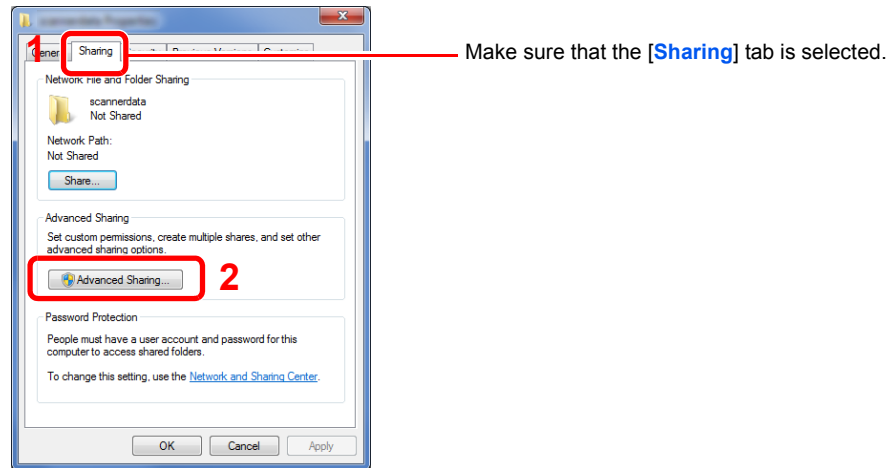

In Windows XP, right-click the "scannerdata" folder and select **[Sharing and Security]** (or **[Sharing]**).

2 Configure permission settings.

- 1 Select the **[Share this folder]** checkbox and click the **[Permissions]** button.

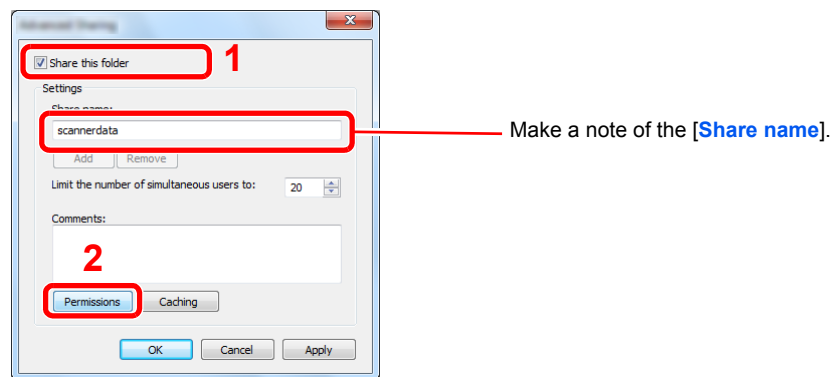

In Windows XP, select **[Share this folder]** and click the **[Permissions]** button.

- 2 Click the **[Add]** button.

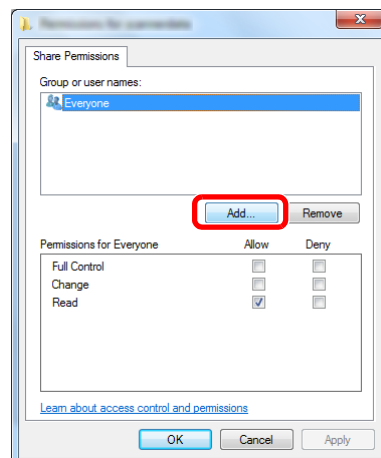

3

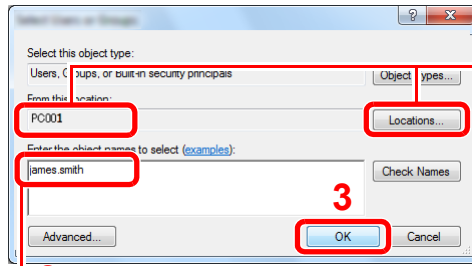

1 If the computer name that you made a note of on page [Making a note of the computer name and full computer name on page 3-36](#) is the same as the domain name: If the computer name is not shown in "From this location", click the **[Locations]** button, select the computer name, and click the **[OK]** button. Example: PC001

2 Enter the user name that you made a note of on page [Making a note of the user name and domain name on page 3-37](#) in the text box, and click the **[OK]** button.

If the computer name that you made a note of on page [Making a note of the computer name and full computer name on page 3-36](#) is not the same as the domain name: If the text after the first dot (.) in the full computer name that you made a note of does not appear in "From this location", click the **[Locations]** button, select the text after the dot (.), and click the **[OK]** button. Example: abcdnet.com

4

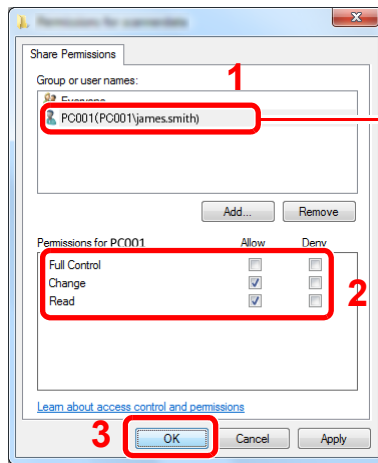

Select the user you entered.

Select the **[Allow]** checkbox of the "Change" and "Read" permissions and press **[OK]**.

In Windows XP, go to step 6.



NOTE

"Everyone" gives sharing permission to everyone on the network. To strengthen security, it is recommended that you select "Everyone" and remove the "Read" **[Allow]** checkmark.

5 Click the **[OK]** button in the "Advanced Sharing" screen to close the screen.

6

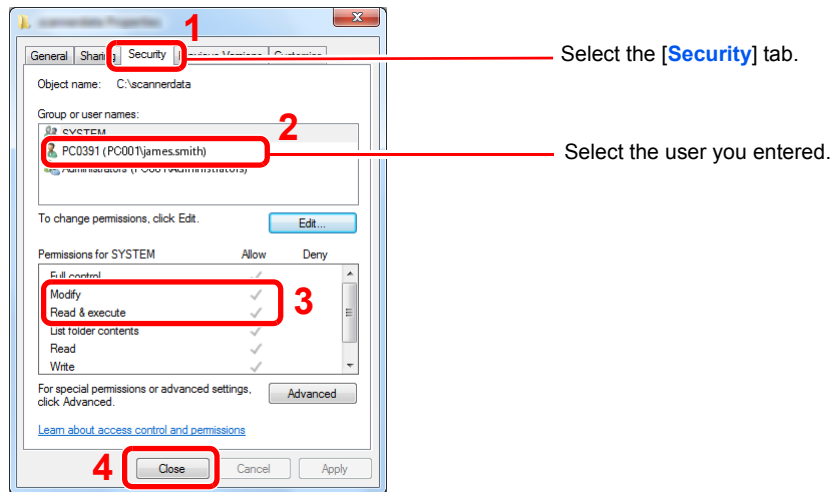

Select the [Security] tab.

Select the user you entered.

Make sure that checkmarks appear on [Allow] checkbox for the "Modify" and "Read & execute" permissions, and click the [Close] button.

In Windows XP, make sure that checkmarks appear on [Allow] checkbox for the "Modify" and "Read & execute" permissions, and click the [OK] button.

Configuring Windows Firewall (for Windows 7)

Permit sharing of files and printers and set the port used for SMB transmission.

NOTE

Log on to Windows with administrator privileges.

1 Check file and printer sharing.

- 1 From [Start] button on the Windows, select [Control Panel], [System and Security], and [Allow a program through Windows Firewall].

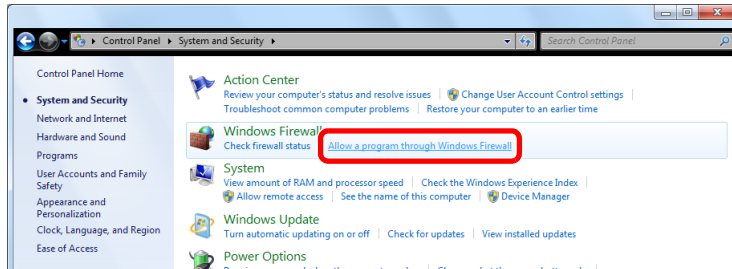

NOTE

If the User Account Control dialog box appears, click the [Continue] button.

2

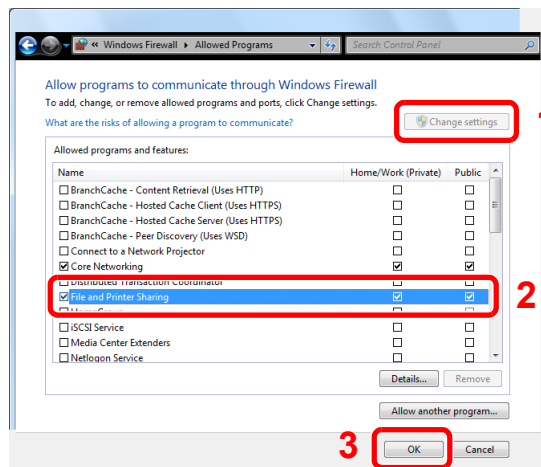

Select the [File and Printer Sharing] checkbox.

2 Add a port.

- 1 From [Start] button on the Windows, select [Control Panel], [System and Security], and [Check firewall status].

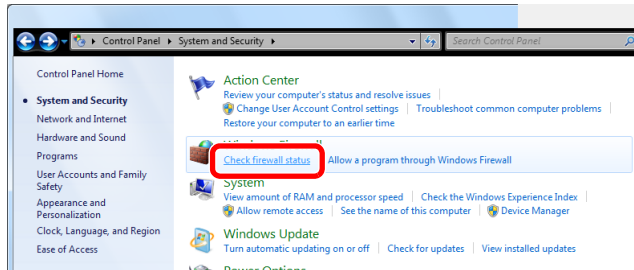

2

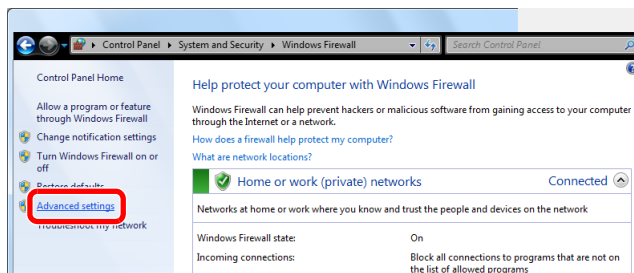

3

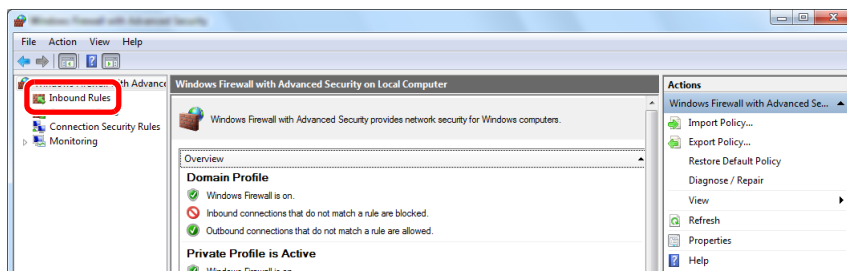

4

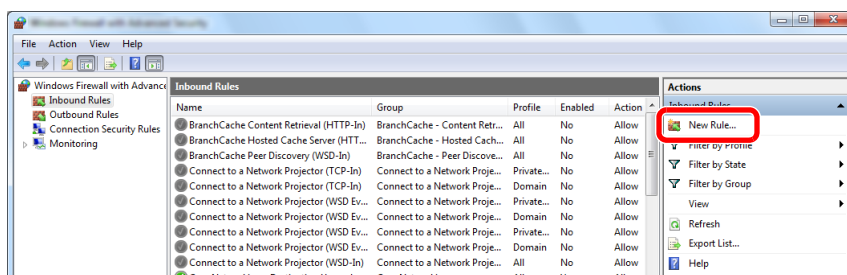

5

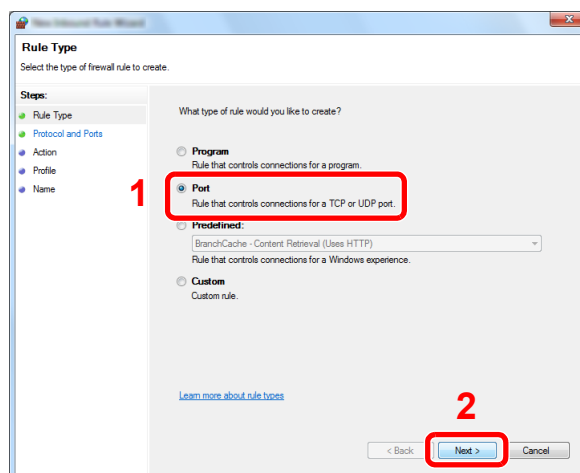

6

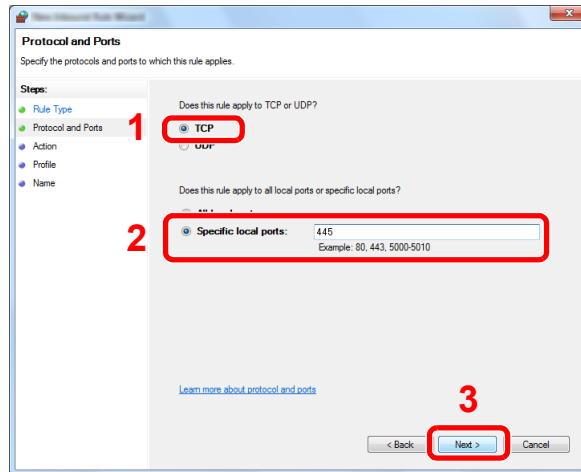

Select [**Specific local ports**], and enter "445".

7

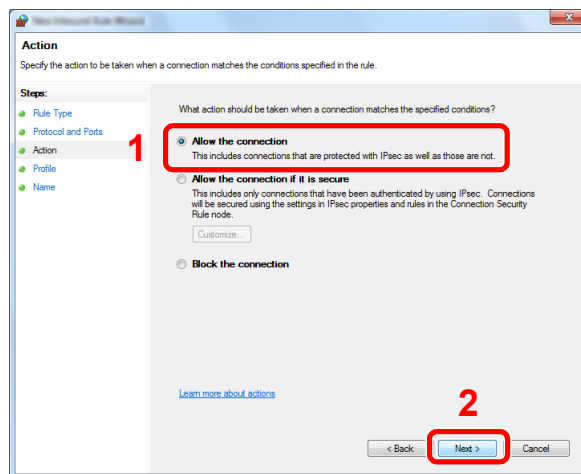

8

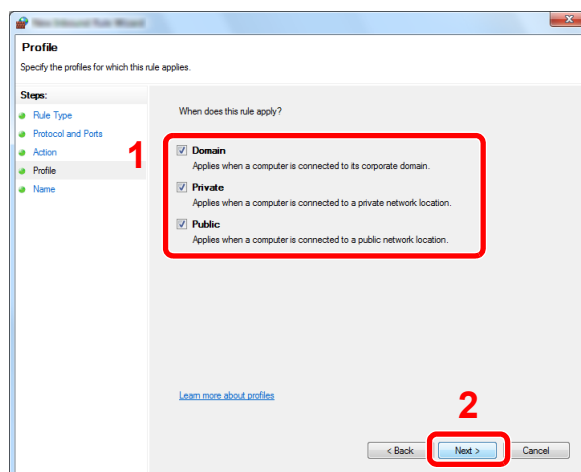

Make sure all checkboxes are selected.

9

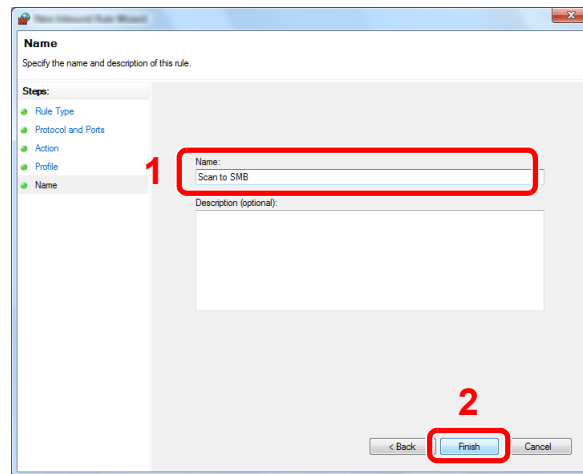

Enter "Scan to SMB" in "Name" and click [Finish].

In Windows XP or Windows Vista

- 1 In Windows XP, from [Start] button on the Windows, select [Control Panel], and then [Windows Firewall].
In Windows Vista, from [Start] button on the Windows, select [Control Panel], [Security], and then [Turn Windows Firewall on or off].
If the User Account Control dialog box appears, click the [Continue] button.
- 2 Click the [Exceptions] tab and then the [Add port...] button.
- 3 Specify Add a Port settings.
Enter any name in "Name" (example: Scan to SMB). This will be the name of the new port.
Enter "445" in "Port Number". Select [TCP] for "Protocol".
- 4 Click [OK] button.

In Windows 8

- 1 In charms on Desktop, click [Settings], [Control Panel], [System and Security], and then [Windows Firewall].
If the User Account Control dialog box appears, click the [Continue] button.
- 2 Configure the settings, refer to [Configuring Windows Firewall \(for Windows 7\) on page 3-42](#).

Registering Destinations in the Address Book

Save frequently used destinations to the Address Book or One Touch Keys. The saved destinations can be changed. The destinations are available for Send as E-mail, Send to Folder, and Fax Transmission (optional).

NOTE

- Registering and editing of the Address Book can also be done in Command Center RX.

 [Registering Destinations \(page 2-40\)](#)

Adding a Destination (Address Book)

Add a new destination to the Address Book. There are two registering methods, contacts and groups. When adding a group, enter the group name and select group members from the Address Book.

NOTE

If user login administration is enabled, you can only edit destinations in the Address Book by logging in with administrator privileges.

Contact

A maximum of 2,000 contact addresses can be registered. Each address can include the information such as destination name, E-mail address, FTP server folder path, computer folder path, and FAX No. (optional).

1 Display the screen.

- 1** Press the **[System Menu]** key.

System Menu



- 2** Press in the following sequence: [], [Edit Destination], [Add/Edit] in "Address Book", [Add], [Contact], and then [Next].

2 Add the name.

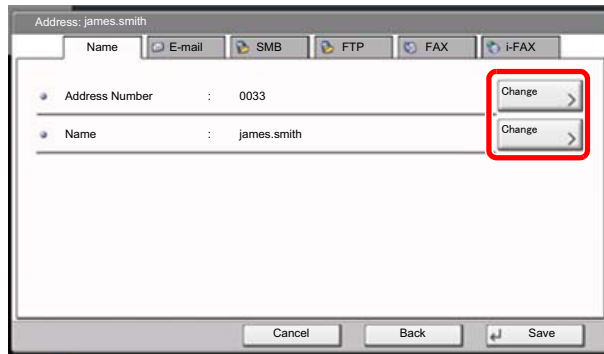

- 1 To specify the "Address Number", press [Change] in Address Number.
- 2 Use [+] / [-] or the numeric keys to enter an address number (1 to 2500).
To have the number assigned automatically, enter "0000".

NOTE

Address Number is an ID for a destination. You can select any available number out of 2,000 numbers for contacts and 500 numbers for groups.
If you specify an address number that is already in use, an error message appears when you press [Save] and the number cannot be registered. If you set "0000" as the address number, the address is registered under the lowest available number.

- 3 Press [OK].
The screen shown in step 1 reappears.
- 4 Press [Change] of "Name".
- 5 Enter the destination name (up to 32 characters) to be displayed on the Address Book and press [OK].
The screen shown in step 1 reappears.

NOTE

Refer to the [Character Entry Method on page 11-10](#) for details on entering characters.

3 Add the address.

- 1 Press [E-mail] to add an E-mail address, [SMB] to add a folder on the PC, or [FTP] to add an FTP folder.

The procedure differs depending on the transmission method selected.

E-mail Address

Press [Change] of "E-mail Address", enter the E-mail address and press [OK]. The table below explains the items to be entered.



NOTE

Refer to the [Character Entry Method on page 11-10](#) for details on entering characters.

The Folder (SMB) Address

Press [Change] of "Host Name", "Path", "Login User Name" and "Login Password", enter the information for each item and press [OK].

The table below explains the items to be entered.

**NOTE**

For the computer name, share name, domain name, and user name, enter the information that you noted when you created the shared folder. For details on creating shared folders, refer to [Preparation for Sending a Document to a PC on page 3-36](#).

Item	Description	Max. No. of Characters
Host Name*	Computer name	Up to 64 characters
Path	Share name For example: scannerdata If saving in a folder in the shared folder: "share name\folder name in shared folder"	Up to 128 characters
Login User Name	If the computer name and domain name are the same: User Name For example: james.smith If the computer name and domain name are different: Domain name\User name For example: "abcdnet\james.smith"	Up to 64 characters
Login Password	Windows logon password (Case sensitive.)	Up to 64 characters

- * To specify a port number different from the default (445), enter using the format "Host name: port number" (Example: SMBhostname:140).
To enter the IPv6 address, enclose the address in brackets [].
(Example: [3ae3:9a0:cd05:b1d2:28a:1fc0:a1:10ae]:140)

To search for a folder on a PC on the network, press [Next] of "Search Folder from Network" or "Search Folder by Host Name".

If you selected "Search Folder from Network", you can enter the "Domain/Workgroup", and "Host Name" to search PCs on the network for the destination.

If you pressed "Search Folder by Host Name", you can search all PCs on the network for a destination.

A maximum of 500 addresses can be displayed. Select the host name (PC name) that you want to specify in the screen that appears, and press [Next]. The login user name and login password entry screen appears.

**NOTE**

Refer to the [Character Entry Method on page 11-10](#) for details on entering characters. Press [Connection Test] to check the connection to the server you chose. If the connection fails, check the entries you made.

The Folder (FTP) Address

Press [Change] of "Host Name", "Path", "Login User Name" and "Login Password", enter the information for each item and press [OK].

The table below explains the items to be entered.

Item	Descriptions	Max. No. of Characters
Host Name*	Host name or IP address of FTP server	Up to 64 characters
Path	Path for the file to be stored For example, "User\ScanData". If no path is entered, the file is stored in the home directory.	Up to 128 characters
Login User Name	FTP server login user name	Up to 64 characters
Login Password	FTP server login password	Up to 64 characters

- * If you specify a port number other than the default (21), use the "Host name: port number" (Example: FTPhostname:140).
To enter the IPv6 address, enclose the address in brackets [].
(Example: [3ae3:9a0:cd05:b1d2:28a:1fc0:a1:10ae]:140)



NOTE

- Refer to the [Character Entry Method on page 11-10](#) for details on entering characters.
- Press [Connection Test] to check the connection to the FTP server you chose. If the connection fails, check the entries you made.

- 2 Check if the destination entry is correct and press [Save]. The destination is added to the Address Book.

To register the registered address in a one-touch key, press [Yes] in the pop-up screen that appears after [Save] is pressed.



NOTE

To register a new One Touch Key, refer to [Adding a Destination on One Touch Key \(One Touch Key\) on page 3-54](#).

Group

Compile two or more contacts into a group. Designations in the group can be added at the same time. When adding a group, a maximum of 500 groups can be added in the Address Book.

NOTE

To add a group, you need individually added destinations. Register one or more individual destinations as needed before proceeding. Up to 100 destinations for the E-mail, 500 destinations for the FAX, and a total of 10 destinations for the FTP and SMB can be registered per group.

1 Display the screen.

- 1 Press the [System Menu] key.

System Menu



- 2 Press [∨], [Edit Destination], [Add/Edit] of "Address Book", [Add], [Group]; and then [Next].

2 Add the name.

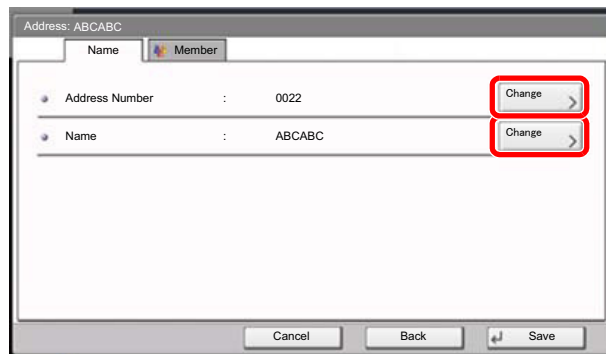

- 1 To specify the "Address Number", press [Change] in Address Number.
- 2 Use [+] / [-] or the numeric keys to enter an address number (1 to 2,500). To have the number assigned automatically, set "0000".

NOTE

Address Number is an ID for a group. You can select any available number out of 2,000 numbers for contacts and 500 numbers for groups. If you specify an address number that is already in use, an error message appears when you press [Save] and the number cannot be registered. If you set "0000" as the address number, the address is registered under the lowest available number.

- 3 Press [OK]. The "Add Group" screen reappears.
- 4 Press [Change] of "Name".
- 5 Enter the group name displayed on the Address Book not more than 32 characters and press [OK].

3 Select the members (destinations).

- 1 Press [Member] and then [Add].

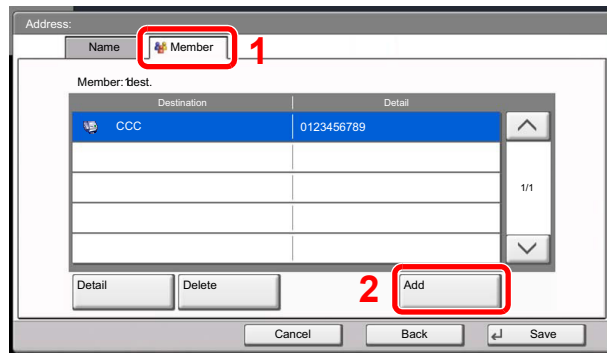

- 2 Select destinations (contacts) to add to the group.



NOTE

Destinations can be sorted or searched by destination name or address number. For details, refer to [Specifying Destination on page 5-26](#).

- 3 Press [OK].

If you have more destinations to add, repeat Steps 2 to 4.

- 4 Check if the selected destination was added to the group and press [Save]. Now the group is added to the Address Book.

To register the registered address in a one-touch key, press [Yes] in the pop-up screen that appears after [Save] is pressed.



NOTE

To register a new One Touch Key, refer to [Adding a Destination on One Touch Key \(One Touch Key\) on page 3-54](#).

Editing and Deleting Address Book Entries

Edit and delete the destinations (contacts) you added to the Address Book.

1 Display the screen.

- 1 Press the [System Menu] key.

System Menu



- 2 Press [√], [Edit Destination] and then [Add/Edit] of "Address Book".
- 3 Select a destination or group to edit.



NOTE

Destinations can be sorted or searched by destination name or address number. For details, refer to [Specifying Destination on page 5-26](#).

- 4 Press [Detail].
The procedure differs depending on the details to be edited.

2 Edit or delete a favorite.

Editing a Contact

- 1 Change "Address Number", "Name" and destination type and address. Refer to [Contact on page 3-46](#) for the details.
- 2 After you have completed the changes, press [Save].
- 3 Press [Yes] in the change confirmation screen to register the changed destination.

Editing a Group

- 1 Change "Address Number" and "Name". Refer to [Group on page 3-51](#) for the details.
- 2 Press [Member].
- 3 To delete any destination from the group, select the destination and press [Delete]. Press [Yes] on the screen to confirm the deletion.
To add the destination, press [Add].
- 4 After you have completed the changes, press [Save].
- 5 Press [Yes] in the change confirmation screen to register the changed group.

Deleting a Contact or Group

Press [Delete]. Press [Yes] on the screen to confirm the deletion.

Adding a Destination on One Touch Key (One Touch Key)

Assign a new destination (contact or group) to an one touch key. A maximum of 1,000 destinations can be registered.

NOTE

- Refer to [Specifying Destination on page 5-26](#) for use of One Touch Key.
- You can add One Touch keys and change their settings on Command Center RX.

 [Registering Destinations \(page 2-40\)](#)

1 Display the screen.

- Press the [System Menu] key.

System Menu



- Press in the following sequence: [√], [Edit Destination], and then [Add/Edit] in "One Touch Key".

2 Add One Touch Keys.

- Select a One Touch Key number (0001 to 1000) for the destination, and press [Add/Edit]. Pressing [Quick No. Search] key or [No.] enables direct entry of a One Touch Key number. Select a One Touch Key with no registered destination.

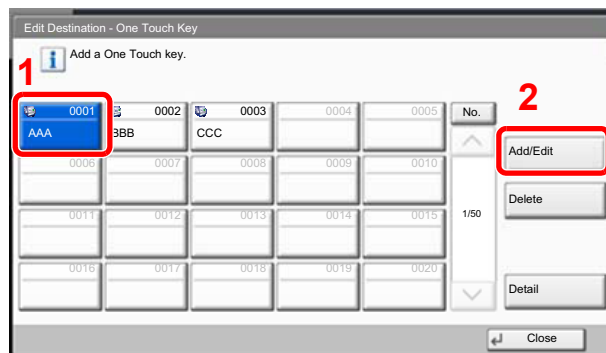

- Press [Change] of "Display Name".
- Enter the One Touch Key name (up to 24 characters) displayed in the send base screen, and press [OK].

NOTE

Refer to the [Character Entry Method on page 11-10](#) for details on entering characters.

- Press [Change] of "Destination". The address book appears.
- Select a destination (contact or group) to add to the One Touch Key number, and press [OK]. Pressing [Detail] shows the detailed information of the selected destination.

NOTE

Destinations can be sorted or searched by destination name or address number. For details, refer to [Specifying Destination on page 5-26](#).

- Press [Save].
The destination will be added to the One Touch Key.

Editing and Deleting One Touch Key

Edit/delete the destinations you added to One Touch Key.

1 Display the screen.

- 1 Press the [**System Menu**] key.

System Menu



- 2 Press [∨], [Edit Destination] and then [Add/Edit] of "One Touch Key".
- 3 Select a One Touch Key number (0001 to 1000) for the destination.
Pressing [**Quick No. Search**] key or [No.] enables direct entry of a One Touch Key number.
The procedure differs depending on the details to be edited.

2 Edit and delete the destinations you added to One Touch Key.

Changing the Registered Information

- 1 Press [Add/Edit].
- 2 Select a new destination (Contact or group). Pressing [Detail] shows the detailed information of the selected destination.



NOTE

Destinations can be sorted or searched by destination name or address number. For details, refer to [Specifying Destination on page 5-26](#).

- 3 Press [OK].
- 4 Press [Yes] on the screen to add the destination to the One Touch Key.

Deleting the Registered Information

- 1 Press [Delete].
- 2 Press [Yes] on the screen to confirm the deletion of the data registered in the One Touch Key.

4 Printing from PC

This chapter explains the following topics:

Printing from PC	4-2
Printer driver print settings screen	4-5
Printer Driver Help	4-6
Changing the default printer driver settings (Windows 7)	4-6
Canceling printing from a computer	4-6
Banner printing	4-7
Printing Data Saved on the Printer	4-14
Private Print/Stored Job	4-14
Quick Copy/Proof and Hold	4-16

Printing from PC

Follow the steps below to print documents from applications.

NOTE

- To print the document from applications, install the printer driver on your computer from the supplied DVD (Product Library).
- In some environments, the current settings are displayed at the bottom of the printer driver.

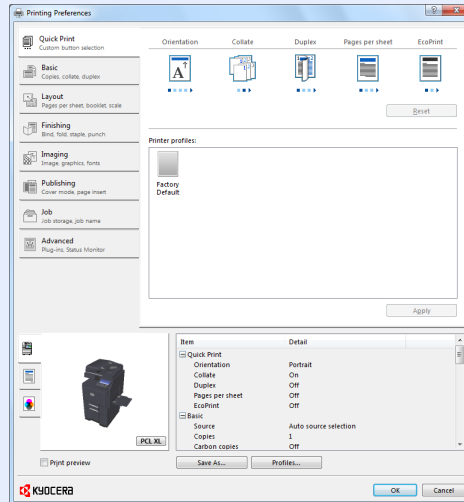

- When printing the cardstock or envelopes, load the cardstock or envelopes before performing the following procedure.
(Refer to [When you load envelopes or cardstock in the multi purpose tray on page 3-28.](#))

1 Display the screen.

Click [**File**] and select [**Print**] in the application.

2 Configure the settings.

- 1 Select the machine from the "Name" menu and click the [**Properties**] button.

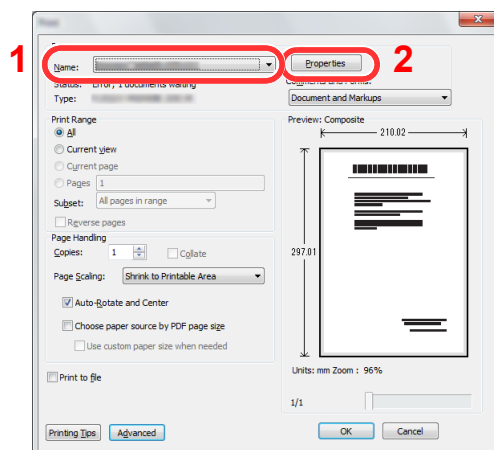

2 Select the [Basic] tab.

3 Click "Print size" menu and select the paper size to use for printing.

To load the paper of size that is not included in print sizes of the machine such as cardstock or envelopes, the paper size needs to be registered.

 [Registering the Original Size \(page 4-3\)](#)

To print on the special paper such as thick paper or transparency, click "Media type" menu and select the media type.

When a document length from 470.1 mm (18.51") to a maximum of 1220.0 mm (48") is specified for printing, the print job is treated as banner printing.

 [Banner printing \(page 4-7\)](#)

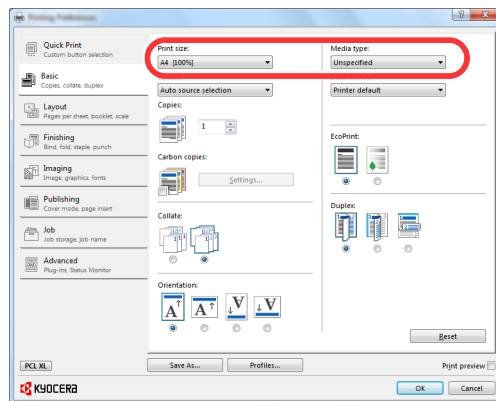

4 Click [OK] button to return to the Print dialog box.

3 Start printing.

Click the [OK] button.

Registering the Original Size

If you loaded a paper size that is not included in the print sizes of the machine, register the paper size in the [Basic] tab of the print settings screen of the printer driver.

The registered size can be selected from the "Print size" menu.

NOTE

To execute printing at the machine, set the paper size and type in [Specifying Paper Size and Media Type for the Cassettes on page 3-31](#).

1 Display the print settings screen.

2 Register the paper size.

1 Click the [Basic] tab.

2 Select [Custom] in the "Print size" menu.

3 Click the [New] button.

4 Enter the name of the paper.

5 Enter the paper size.

When a document length from 470.1 mm (18.51") to a maximum of 1220.0 mm (48") is specified for printing, refer to [Banner printing on page 4-7](#).

6 Click the [OK] button.

7 In the "Print size" menu, select the paper size (name) that you registered in steps 4 to 7.

8 Click [MP tray] in the "Source" menu.

9 Select the type of paper in the "Media type" menu.

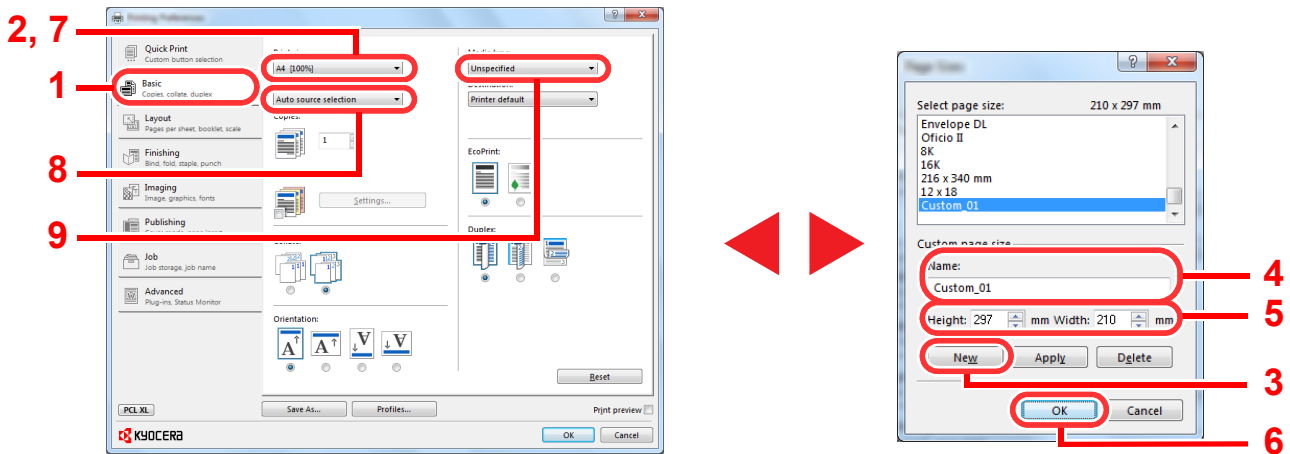

NOTE

- If you loaded a postcard or envelope, select [Cardstock] or [Envelope] in the "Media type" menu.
- To select the 4,000-Sheet Finisher tray or 1,000-Sheet Finisher tray for the output tray when printing envelopes, select the following:

4,000-Sheet Finisher

Print paper size	Output tray
Envelopes other than Envelope C4	Tray C (facedown)
Envelope C4	Tray B (facedown)

1,000-Sheet Finisher

Print paper size	Output tray
All envelopes	Finisher Top Tray (facedown)

Printer driver print settings screen

The printer driver print settings screen allows you to configure a variety of print-related settings. For more information, refer to the **Printer Driver User Guide** on the DVD.

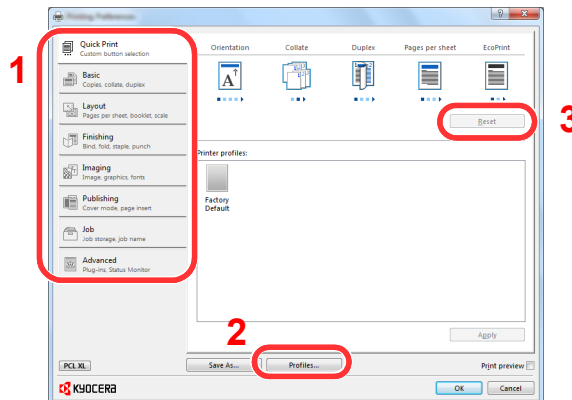

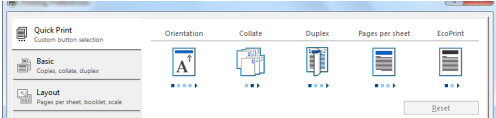
No.	Description
1	<p>[Quick Print] tab</p> <p>Provides icons that can be used to easily configure frequently used functions. Each time you click an icon, it changes to an image resembling the print results and applies the settings.</p>  <p>[Basic] tab</p> <p>This tab groups basic functions that are frequently used. You can use it to configure the paper size, destination, and duplex printing.</p> <p>[Layout] tab</p> <p>This tab lets you configure settings for printing various layouts, including booklet printing, combine mode, poster printing, and scaling.</p> <p>[Finishing] tab</p> <p>This tab lets you configure settings related to finishing of printed media, including binding and stapling.</p> <p>[Imaging] tab</p> <p>This tab lets you configure settings related to the quality of the print results.</p> <p>[Publishing] tab</p> <p>This tab lets you create covers and inserts for print jobs and put inserts between sheets of OHP film.</p> <p>[Job] tab</p> <p>This tab lets you configure settings for saving print data from the computer to the machine. Regularly used documents and other data can be saved to the machine for easy printing later. Since saved documents can be printed directly from the machine, this function is also convenient when you wish to print a document that you don't want others to see.</p> <p>[Advanced] tab</p> <p>This tab lets you configure settings for adding text pages or watermarks to print data.</p>
2	<p>[Profiles]</p> <p>Printer driver settings can be saved as a profile. Saved profiles can be recalled at any time, so it's a convenient practice to save frequently used settings.</p>
3	<p>[Reset]</p> <p>Click to revert settings to their initial values.</p>

Printer Driver Help

The printer driver includes Help. To learn about print settings, open the printer driver print settings screen and display Help as explained below.

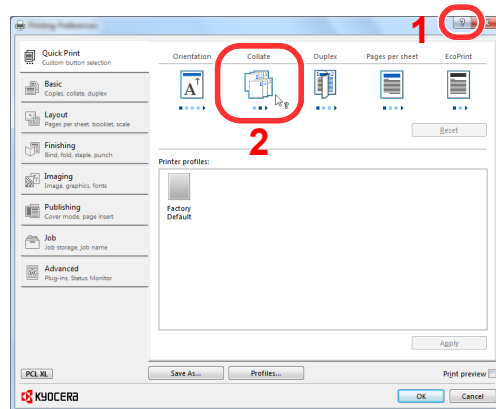

- Click the [?] button in the upper right corner of the screen and then click the item you want to know about.
- Click the item you want to know about and press the [F1] key on your keyboard.

Changing the default printer driver settings (Windows 7)

The default printer driver settings can be changed. By selecting frequently used settings, you can omit steps when printing. For the settings, refer to **Printer Driver User Guide**.

- 1 Click [Start] button on the Windows, and then click [Devices and Printers].
- 2 Right-click the printer driver icon of the machine, and click the [Printer properties] menu of the printer driver.
- 3 Click the [Basic] button on the [General] tab.
- 4 Select the default settings and click the [OK] button.

Canceling printing from a computer

To cancel a print job executed using the printer driver before the printer begins printing, do the following:



NOTE

When canceling printing from this machine, refer to [Canceling Jobs on page 5-18](#).

- 1 Double-click the printer icon () displayed on the taskbar at the bottom right of the Windows desktop to display a dialog box for the printer.
- 2 Click the file for which you wish to cancel printing and select [Cancel] from the "Document" menu.

Banner printing

When a document length from 470.1 mm (18.51") to a maximum of 1220.0 mm (48") is specified for printing, the print job is treated as banner printing.

Max. number of sheets	1 sheet (manual feed), 10 sheets (when optional banner tray is attached*)
Paper width	210 to 304.8 mm (8.26" to 12")
Paper length	Max. 1220 mm (48")
Paper weight	136 to 163 g/m ²
Media type	Heavy 2

* When the banner tray (option) is used, up to 10 sheets of banner paper can be fed continuously. (Refer to [Using the Banner Tray \(Option\) on page 4-10.](#))

Follow the steps below to set banner paper in the printer driver.

1 Display the screen for registering the original size.

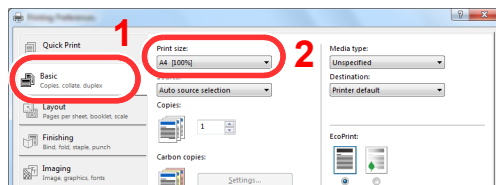

- 1 Click the **[Basic]** tab.
- 2 Select **[Custom]** in the "Print size" menu.

2 Register the original size.

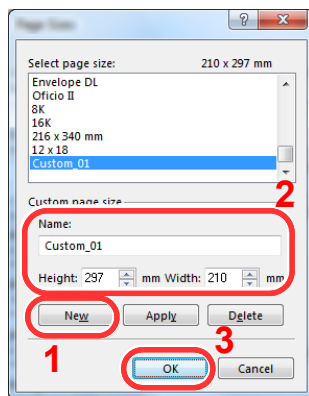

- 1 Click the **[New]** button.
- 2 Enter the name, length (470.1 mm (18.51") or longer), and width of the custom paper size being registered.
- 3 Click the **[OK]** button.

3 Setting the print paper size.

- 1 Select the custom paper size that you registered in the "Print size" menu.

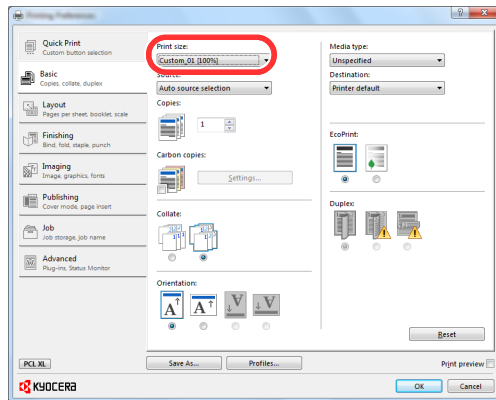

- 2 Click the [OK] button.



NOTE

When KPDL is used for "PDL" Settings of the printer driver, a length setting of 470.5 mm (18.53") or longer is handled as banner print.

When you execute printing in this case, a message appears on the machine's operation panel. Place the paper in the multipurpose tray, continue to support it so that it does not fall, and press [Continue]. To cancel printing, press [Cancel].

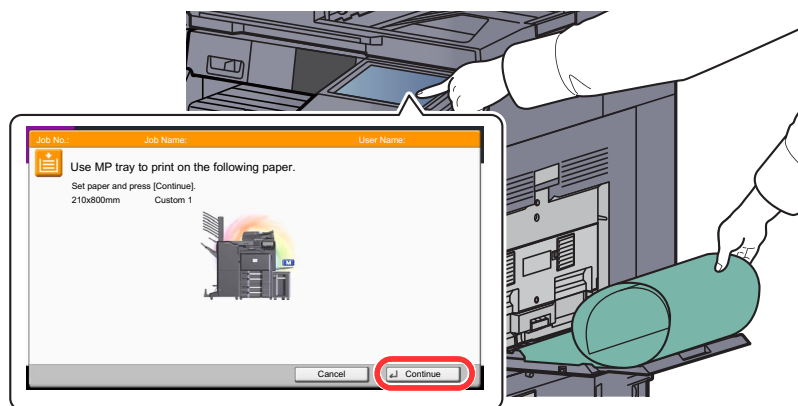

✔ **IMPORTANT**

If an output tray that cannot be used for banner printing such as Mailbox (option) is selected in the printer driver, the output tray automatically changes to a tray that can be used.

To print on multiple sheets using the multi purpose tray, place each sheet after the previous sheet is printed, and press [Continue].

After pressing [Continue], support the paper with both hands so that it feeds in correctly.

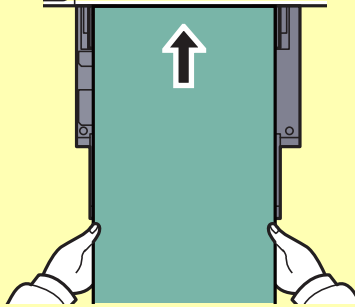

After printing starts, catch the paper when it is output so that it does not fall. When using the inner tray as the output location, do not stand up the stopper.

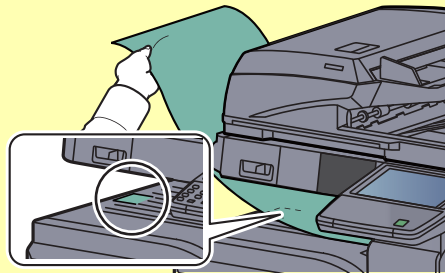

Using the Banner Tray (Option)

When the banner tray (option) is used, up to 10 sheets of banner paper can be fed continuously.



NOTE

The paper length supported in banner tray is 900 to 1220 mm.

1 Open the multi purpose tray.

Open the multi purpose tray until it stops.

Do not extend the multi purpose auxiliary tray.

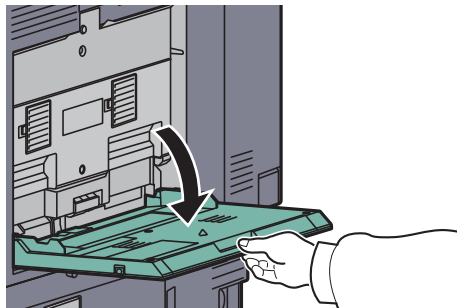

2 Attach the banner tray.

1 Release the paper width guide lock on the banner tray and open to the maximum width.

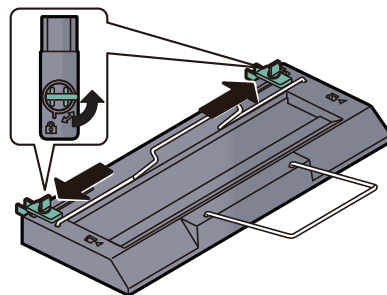

2 Attach the banner tray to the multi purpose tray.

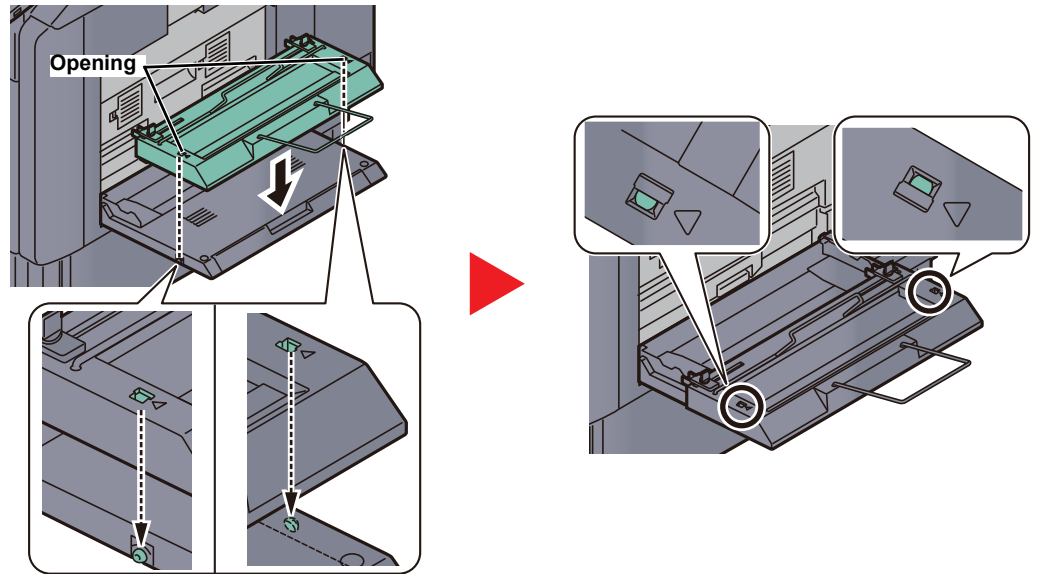

Fit the openings on the sides of the banner tray onto the tabs on the sides of the multi purpose tray, and press into place.

3 Load paper.

1 Open the paper width guides on the multi purpose tray to the maximum width.

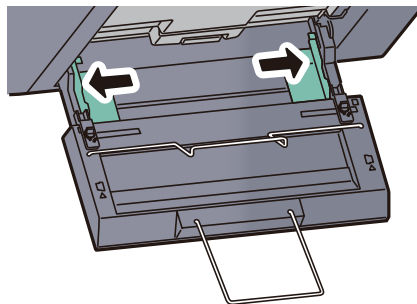

Make sure that the banner tray is attached so that the paper width guides on the banner tray are outside the paper width guides on the multi purpose tray.

2 Load banner paper so that it passes under the paper clamp bar.

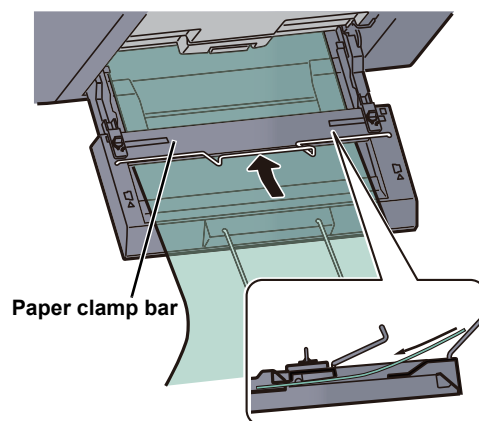

- 3 Loop the banner paper back and place the end on the paper support.

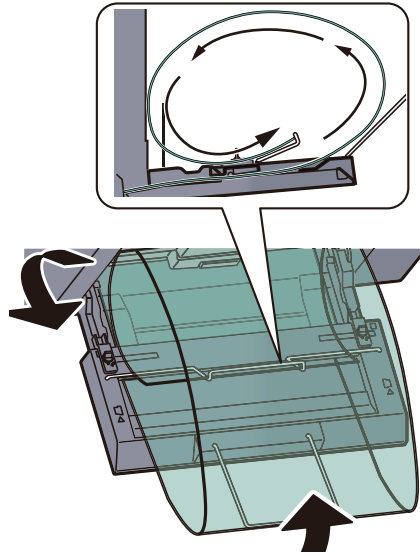

- 4 Adjust the paper width guides to the width of the paper.

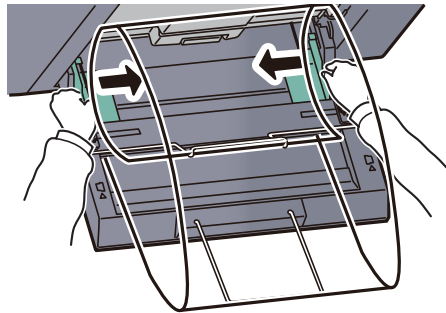

 **IMPORTANT**

If there is a gap between the paper and the paper width guides, readjust the guides to fit the paper in order to prevent skewed feeding and paper jams.

- 5 Adjust the paper width guides on the banner tray to the same width as the paper width guides on the multi purpose tray and lock.

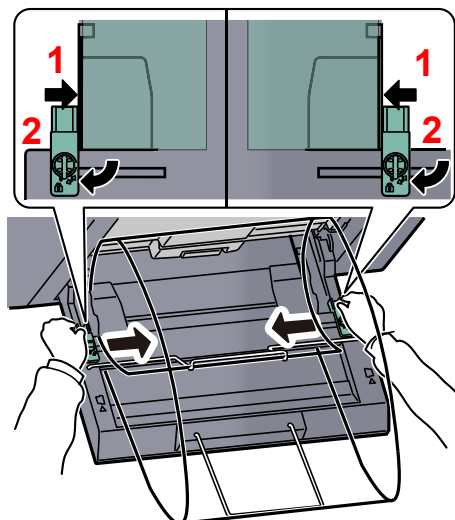

 **IMPORTANT**

Remove the paper when banner printing finishes, or when you are not using the banner tray.

 **NOTE**

The print confirmation screen can be set in System Menu to not appear when the banner tray is attached. This will allow continuous printing on multiple sheets. (Refer to [Message Banner Print on page 8-25.](#))

Printing Data Saved on the Printer

If you configure settings in the [Job] tab of the printer driver and then print, the print job will be saved in the Job Box (memory) and printing can be executed at the machine.

Private Print/Stored Job

Private Print/Stored Job Box stores the print data which is printed by using the printer driver as a Private Print/Stored Job. Refer to the **Printer Driver User Guide** on how to print a job as Private Print or Stored Job using the printer driver.

Printing and Deleting the Document

Print/delete the documents stored in a Private Print/Stored Job box.

The procedure is as follows.

1 Display the screen.

- 1 Press [Job Box] in the home screen.

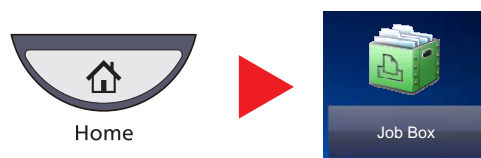

- 2 Select [Private Print/Stored Job] and press [Open].

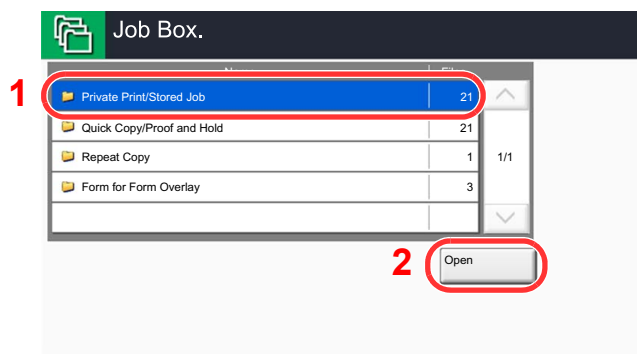

2 Print and delete the document.

Printing the document

- 1 Select the creator of the document and press [Open].

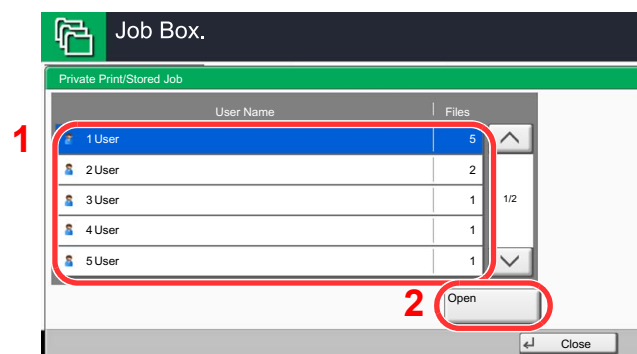

- 2 Select the document to print and press [Print].

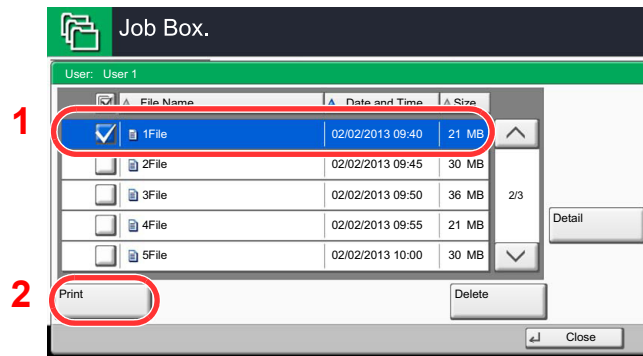

NOTE

If the document is protected by an access code, the password entry screen will be displayed. Enter the password using the numeric keys.

- 3 Specify the number of copies to print as desired.
- 4 Press [Start Print].
Printing starts.
Upon completion of printing, the Private Print job is automatically deleted.

Deleting the document

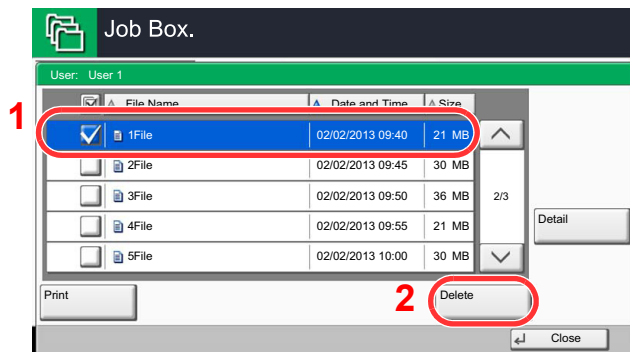

- 1 Select the document to delete and press [Delete].

NOTE

If the document is protected by an access code, the password entry screen will be displayed. Enter the password using the numeric keys.

- 2 Press [Yes] in the confirmation screen.

Quick Copy/Proof and Hold

Quick Copy/Proof and Hold box stores the print data which is printed by using the printer driver as a Quick Copy or Proof and Hold Print job. Refer to the **Printer Driver User Guide** on how to print a job as Quick Copy or Proof and Hold Print job using the printer driver.

NOTE

To maintain free space on the hard disk, you can set the maximum number of stored jobs. For details, refer to [Quick Copy Job Retention on page 8-34](#).

Printing and Deleting the Document

You can print/delete the documents stored in the Quick Copy/Proof and Hold box.

The procedure is as follows.

1 Display the screen.

- 1 Press [Job Box] in the home screen.



- 2 Select [Quick Copy/Proof and Hold].

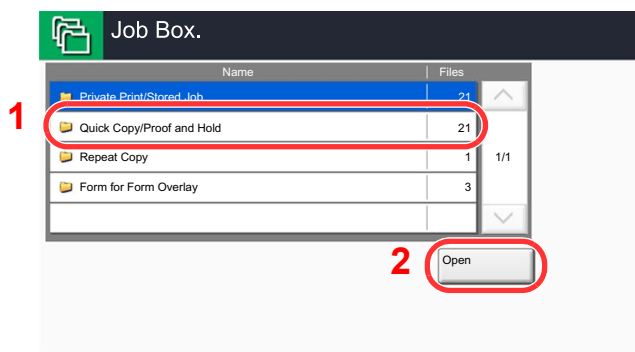

- 3 Press [Open].

2 Print and delete the document.

Printing the document

- 1 Select the creator of the document and press [Open].

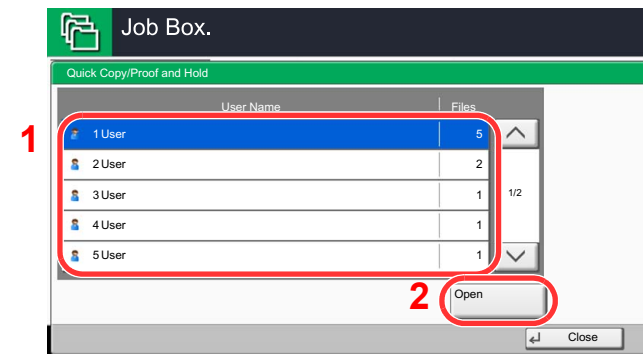

- 2 Select the document to print and press [Print].

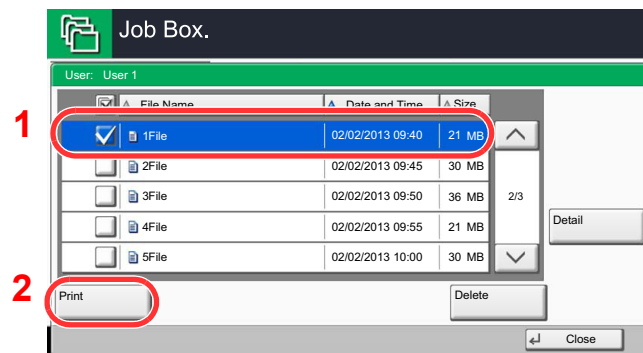

- 3 Specify the number of copies to print as desired.

- 4 Press [Start Print].

Printing starts.

Deleting the document

- 1 Select the document to delete and press [Delete].

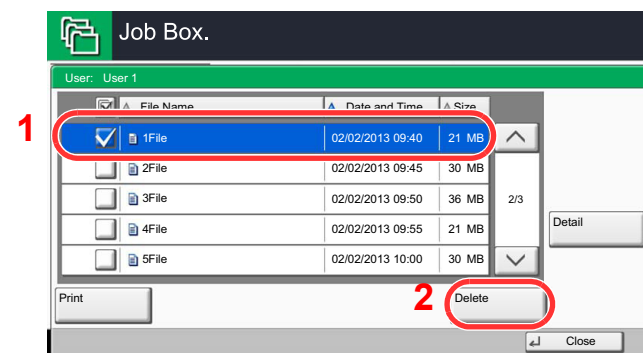

- 2 Press [Yes] in the confirmation screen.

The document is deleted.

5 Operation on the Machine

This chapter explains the following topics:

Loading Originals	5-2
Placing Originals on the Platen	5-2
Loading Originals in the Document Processor	5-3
Checking the Equipment's Serial Number	5-5
Program	5-6
Registering Programs	5-7
Recalling Programs	5-7
Editing and Deleting Programs	5-9
Application	5-10
Installing Applications	5-10
Activating/Deactivating Application	5-11
Deleting Applications	5-13
Registering Shortcuts (Copy, Send, and Document Box Settings)	5-14
Adding Shortcuts	5-14
Editing and Deleting Shortcuts	5-15
Using the Internet Browser	5-16
Launching and Exiting the Browser	5-16
Using the Browser Screen	5-17
Canceling Jobs	5-18
Canceling Jobs	5-18
Canceling printing from a computer	5-19
Copying	5-20
Basic Operation	5-20
Reserve Next	5-21
Interrupt Copy	5-22
Sending	5-23
Basic Operation	5-24
Specifying Destination	5-26
Checking and Editing Destinations	5-34
Confirmation Screen of Destinations	5-35
Sending to Different Types of Destinations (Multi Sending)	5-36
WSD Scan/DSM Scan	5-37
Scanning using TWAIN	5-41
Scanning a document placed in the machine	5-41
Scanning a document stored in a custom box	5-43
Scanning with FMU Connection	5-45
Using FMU Connection to scan an original	5-45
How to use the FAX Function	5-46
What is Document Box?	5-47
Basic Operation for Document Box	5-48
Using a Custom Box	5-53
Creating a New Custom Box (Add/Edit Box)	5-53
Editing Custom Box	5-55
Deleting Custom Boxes	5-55
Storing Documents (Store File)	5-56
Printing Documents (Print)	5-57
Sending Documents (Send)	5-58
Editing Documents	5-60
Deleting Documents	5-64
Job Box	5-65
Outputting Repeat Copy Jobs	5-65
Form for Form Overlay	5-66
Printing Documents Stored in Removable USB Memory	5-68
Saving Documents to USB Memory (Scan to USB)	5-70
Check the USB memory information	5-71
Removing USB Memory	5-72
Manual Staple	5-73

Loading Originals

Placing Originals on the Platen

You may place books or magazines on the platen in addition to ordinary sheet originals.

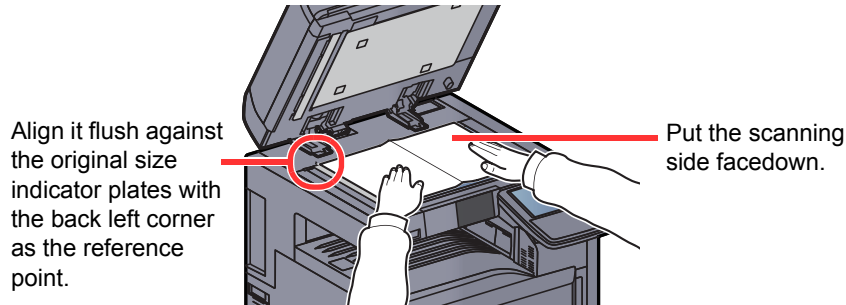

NOTE

For details on Original Orientation, refer to [Original Orientation on page 6-15](#).



CAUTION

Do not leave the platen cover or the optional document processor open as there is a danger of personal injury.



IMPORTANT

Do not push the platen cover or the optional document processor forcefully when you close it. Excessive pressure may crack the platen glass.

When placing books or magazines on the machine, do so with the platen cover or the optional document processor in the open position.

Loading Originals in the Document Processor

The optional document processor automatically scans each sheet of multiple originals. Both sides of two-sided originals are scanned.

Originals Supported by the Document Processor

The document processor supports the following types of originals.

Detail	Document Processor (Automatic 2-Sided)	Document Processor (Dual scan DP)
Weight	45 to 160 g/m ² (duplex: 50 to 120 g/m ²)	35 to 220 g/m ² (duplex: 50 to 220 g/m ²) Sizes smaller than B6-R are 50 to 105 g/m ² (one-side/duplex)
Sizes	Maximum A3 to Minimum A5-R Maximum Ledger to Minimum Statement-R	Maximum A3 to Minimum A6-R Maximum Ledger to Minimum Statement-R
No. of sheets	Plain paper (80 g/m ²), Colored paper, Recycled paper, High Quality: 100 sheets (Mixed size originals: 30 sheets) Thick paper (157 g/m ²): 50 sheets Thick paper (120 g/m ²): 66 sheets Art paper: 1 sheet	Plain paper (80 g/m ²), Colored paper, Recycled paper, High Quality: 175 sheets (Mixed size originals: 30 sheets) Thick paper (157 g/m ²): 89 sheets Thick paper (120 g/m ²): 116 sheets Art paper: 1 sheet

Originals Not Supported by the Document Processor

Do not use the document processor for the following types of originals.

- Soft originals such as vinyl sheets
- Transparencies such as OHP film
- Carbon paper
- Originals with very slippery surfaces
- Originals with adhesive tape or glue
- Wet originals
- Originals with correction fluid which is not dried
- Irregularly shaped (non-rectangular) originals
- Originals with cut-out sections
- Crumpled paper
- Originals with folds (Straighten the folds before loading. Failure to do so may cause the originals to jam.)
- Originals bound with clips or staples (Remove the clips or staples and straighten curls, wrinkles or creases before loading. Failure to do so may cause the originals to jam.)

How to Load Originals

IMPORTANT

- **Before loading originals, be sure that there are no originals left on the original eject table. Originals left on the original eject table may cause the new originals to jam.**
- **Do not make an impact on the document processor top cover, such as aligning the originals on the top cover. It may cause an error in the document processor.**

1 Adjust the original width guides.

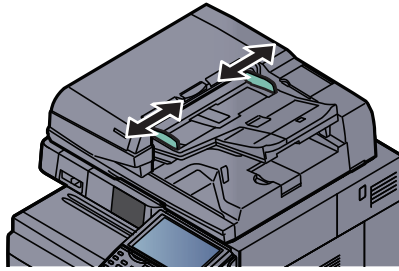

2 Place the originals.

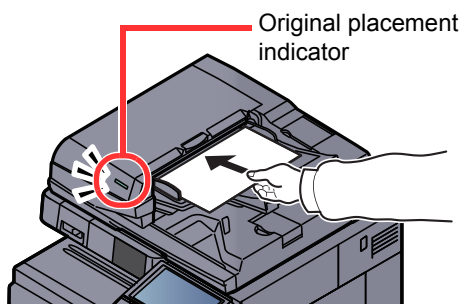

Put the side to be scanned (or the first side of two-sided originals) face-up. Slide the leading edge into the document processor as far as it will go. The original loaded indicator lights when the original is placed correctly.



NOTE

For details on Original Orientation, refer to [Original Orientation on page 6-15](#).



IMPORTANT

Confirm that the original width guides exactly fit the originals. If there is a gap, readjust the original width guides. The gap may cause the originals to jam.

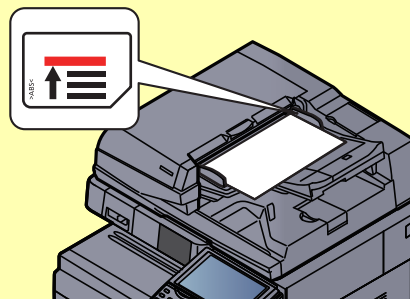

Ensure that loaded originals do not exceed the level indicator. Exceeding the maximum level may cause the originals to jam.

Originals with punched holes or perforated lines should be placed in such a way that the holes or perforations will be scanned last (not first).

Checking the Equipment's Serial Number

The equipment's serial number is printed in the location shown in the figure.

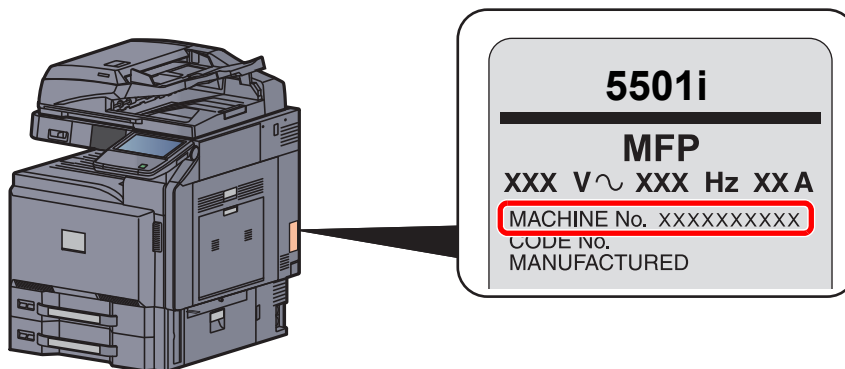



NOTE

You'll need the equipment's serial number when contacting your Service Representative. Please check the number before contacting your Service Representative.

Program

By registering sets of frequently used functions as a single program, you can simply press the program number as needed to recall those functions. You can also name the programs for easy identification when recalling.

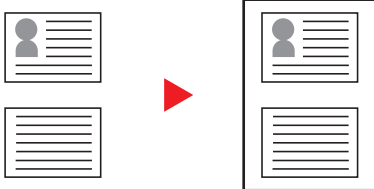
The programs below have been preregistered. The registered contents can be re-registered for easier use in your environment.

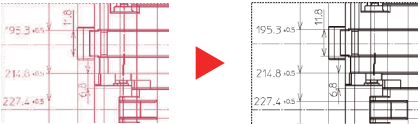
Number	Program name	Description	Default Registration
01	ID Card Copy 	Use this when you want to copy a driver's license or an insurance card. When you scan the front and back of the card, both sides will be combined and copied onto a single sheet.	Copying Functions Combine: [2 in 1] Continuous Scan: [On] Original Size: A5-R Paper Selection: Cassette 1 Zoom: Auto Zoom
02	Eco Copy 	Use this to save toner consumption when printing. This lightens the density to reduce toner consumption.	Copying Functions EcoPrint: [On] (Level [5])
03	Newspaper Copy 	Use this when you want to copy a newspaper article, or other originals printed on a colored substrate. This adjusts the image quality so that the color of the substrate or the text on the reverse side will not show on the copy.	Copying Functions Prevent Bleed-thru: [On] Background Density Adj.: [Auto]
04	Technical Drawing Copy 	Use this when you want to copy a drawing that contains shapes drawn with lines, and graphics.	Copying Functions Original Image: [Text] Sharpness (All): [+3] Background Density Adj.: [Auto]



NOTE

Up to 50 functions combining copying and sending can be registered in the program.
 If user login administration is enabled, you can only register functions by logging in with administrator privileges.

Registering Programs

Use the procedure below to register a program.

The following procedure is an example of registering the copying function.

1 Display the screen.

- 1 Press [Copy] on the Home screen.

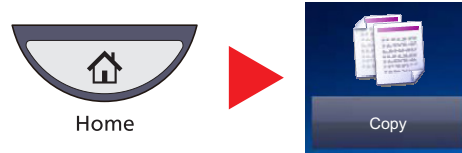

- 2 Press the [Program] tab while the copy mode is accessed.

2 Register the program.

- 1 Press [Add] and press a number (01 to 50) for the program number.



NOTE

If you select a program number already registered, the currently registered functions can be replaced with a new set of functions.

- 2 Press [Next].

- 3 Enter the new program name and press [Save].

The program is registered.

To display a registered program on the Home screen, press [Yes] on the confirmation screen that appears, proceed to step 2-4.

- 4 Specify the position in which you want to display the icon of registered program.

- 5 Press [Save].

Recalling Programs

Use the procedure below to recall a registered program.

1 Recall the program.

- 1 Press [Program] in the Home screen, or the key of the registered program.

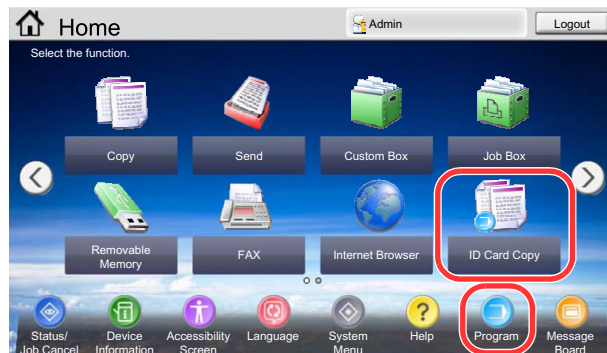

Pressing the key of the registered program will recall the program. If you pressed [Program], proceed to step 1-2.

2 Press the key for the program number you want to recall.

Press the **[Quick No. Search]** key or **[No.]** to enter the program number (01 to 50) directly for recalling.

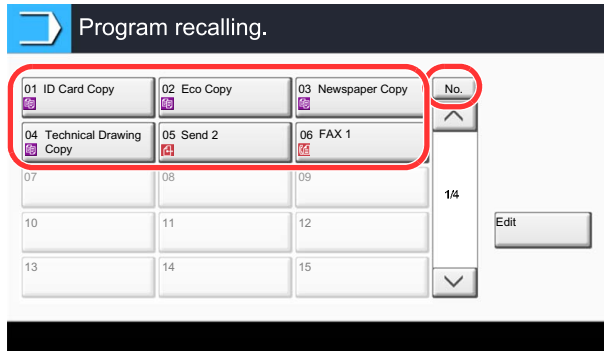

NOTE

If the program cannot be recalled, the Document Box or the form overlay specified in the program might have been deleted. Check the Document Box.

2 **Execute the program.**

Place the originals and press the **[Start]** key.



NOTE

[Program] can be pressed in each function to call up the program registered for the function.

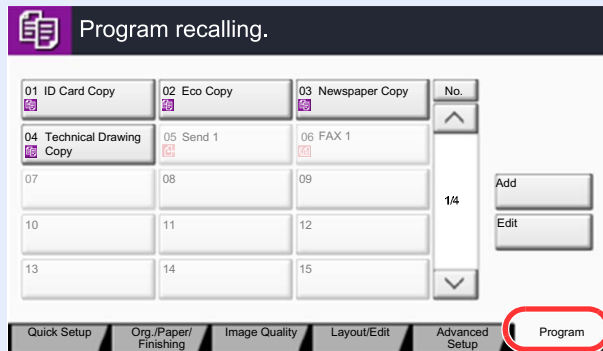

Editing and Deleting Programs

You can change program number and program name, or delete program.

Use the procedure below to edit or delete a program.

NOTE

To modify the settings of a registered program, recall the program you want to change, change its settings, then refer to [Registering Programs on page 5-7](#) to re-register the changed program.

1 Display the screen.

- 1 Press [Program] on the Home screen.

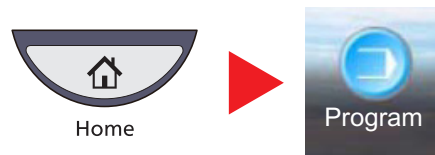

- 2 Press [Edit].

2 Edit the program.

To edit a program

- 1 Press the key(s) corresponding to the program number (01 to 50) to change.
- 2 Press [Edit], and refer to [Registering Programs on page 5-7](#) to change the program number and program name.
- 3 Press [Save].
- 4 Press [Yes] in the confirmation screen.

To delete

- 1 Press the key(s) corresponding to the program number (01 to 50) to delete.
- 2 Press [Delete].
- 3 Press [Yes] in the confirmation screen.

Application

The functionality of the machine can be expanded by installing applications.

Applications that help you perform your daily more efficiently such as a scan feature and an authentication feature are available.

For details, consult your sales representative or dealer.

Installing Applications

The procedure is as follows.

1 Display the screen.

- 1 Press the [System Menu] key.

System Menu



- 2 Press [∨] and then [Application].



NOTE

If the user authentication screen appears, enter your login user name and login password and press [Login]. For this, you need to login with administrator privileges. The factory default login user name and login password are set as shown below.

Model Name	Login User Name	Login Password
3501i	3500	3500
4501i	4500	4500
5501i	5500	5500

2 Install the application.

- 1 Press [Add].
- 2 Insert the removable memory containing the application to be installed into the USB Port (A1).



NOTE

When the message "Removable Memory was recognized. Displaying files. Are you sure?" is displayed, press [No].

- 3 Select the application to be installed and press [Install].
You can view detailed information on the selected application by pressing [Detail].
- 4 Press [Yes] in the confirmation screen.
Installation of the application begins. Depending on the application being installed, the installation may take some time.
Once the installation ends, the original screen reappears.



NOTE

To install another application, repeat steps 2-3 and 2-4.

To remove the removable memory, press [Remove Memory] and wait until the message "Removable Memory can be safely removed." appears. Then remove the removable memory.

Activating/Deactivating Application

The procedure is as follows.

1 Display the screen.

- 1 Press the [System Menu] key.

System Menu



- 2 Press [✓] and then [Application].



NOTE

If the user authentication screen appears, enter your login user name and login password and press [Login]. For this, you need to login with administrator privileges. The factory default login user name and login password are set as shown below.

Model Name	Login User Name	Login Password
3501i	3500	3500
4501i	4500	4500
5501i	5500	5500

2 Activate/Deactivate the application.

- 1 Select the desired application and press [Activate].

You can view detailed information on the selected application by pressing [Detail].



NOTE

To exit the application, press [Deactivate].

- 2 Enter the license key and press [Official].

Some applications do not require you to enter a license key. If the license key entry screen does not appear, go to step 2-3. To use the application as a trial, press [Trial] without entering the license key.

- 3 Press [Yes] in the confirmation screen.



NOTE

- If you change the date/time while using the trial version of an application, you will no longer be able to use the application.
- Icons of activated application are displayed in the Home screen.

3 Press the application icon in the Home screen to activate the application.

Press the application icon.

The application will start up.



NOTE

To exit the application, press [x].

When the application exit confirmation screen appears, press [Yes].

The procedure for exiting some applications may differ.

Deleting Applications

The procedure is as follows.



NOTE

Be sure to set [Deactivate] for the application you want to delete.



[Registering Programs on page 5-7](#)

1 Display the screen.

- 1 Press the [System Menu] key.

System Menu



- 2 Press [✓] and then [Application].



NOTE

If the user authentication screen appears, enter your login user name and login password and press [Login]. For this, you need to login with administrator privileges. The factory default login user name and login password are set as shown below.

Model Name	Login User Name	Login Password
3501i	3500	3500
4501i	4500	4500
5501i	5500	5500

2 Delete the application.

- 1 Select the application you want to delete, and press [Delete].
You can view detailed information on the selected application by pressing [Detail].
- 2 When the deletion confirmation screen appears, press [Yes].

Registering Shortcuts (Copy, Send, and Document Box Settings)

You can register shortcuts in the Quick Setup screen for easy access to the frequently used functions. The settings for the selected function can also be registered. A function name linked to a registered shortcut can be changed as necessary. You can register up to 6 shortcuts for copying functions, sending functions, and functions set for document box.

Adding Shortcuts

Shortcut registration is performed in the setup screen of each function. Shortcuts can be registered for all functions in which [Add Shortcut] appears on the screen.

Use the procedure below to register a shortcut.

- 1 In each function, display the configuration screen you want to register.**
- 2 Register the shortcuts.**
 - 1 Select the setting you want to add.
 - 2 Press [Add Shortcut].

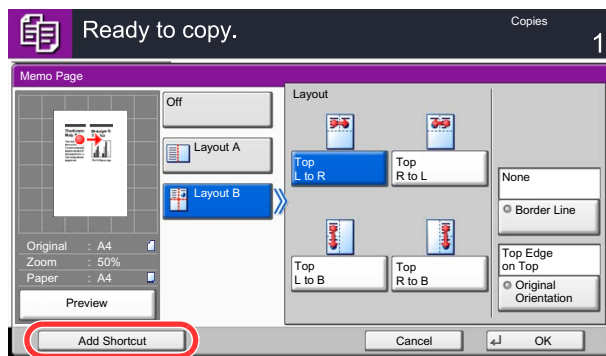

- 3 Press the keys corresponding to the shortcut number (01 to 06) to register.**



NOTE

If you select a shortcut number already registered, the currently registered shortcut can be replaced with a new one.

- 4 Enter the shortcut name and press [Save].**

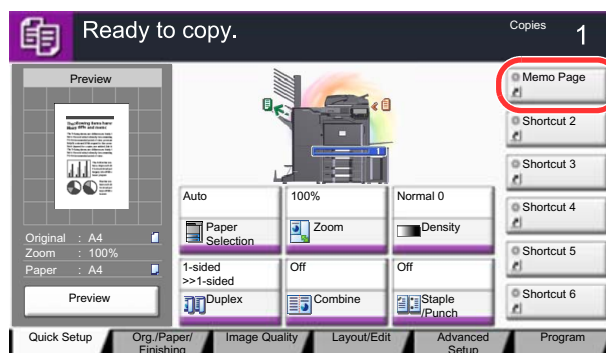

The shortcut is registered.

Editing and Deleting Shortcuts

Follow the steps shown below to change a shortcut number/name or delete a shortcut.

1 In the setup screen of each function, press [Add Shortcut] in the bottom of the screen.

2 Edit the shortcut.

- 1 Press [Edit].
- 2 Press the shortcut key you want to edit/delete.

To edit a shortcut

- 3 Press [Change] of "Shortcut No." or "Shortcut Name".
- 4 Change the settings, and press [OK].
- 5 Press [Save].

To delete

- 3 Press [Delete this Shortcut].
- 4 Press [Yes] in the confirmation screen.

Using the Internet Browser

If the machine is connected to the network, you can browse the Internet on the touch panel.

NOTE

To use the internet browser, "Internet Browser Setting" must be set to [On] in [Internet on page 8-60](#).

Launching and Exiting the Browser

Use the procedure below to launch and exit the Internet browser.

Display the screen.

- 1 Press [Internet Browser] on the Home screen.

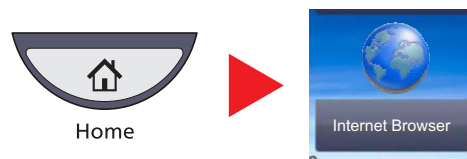

The Internet browser starts up.

- 2 Use the browser screen to browse web pages.

 For information on how to use the browser screen, refer to [Using the Browser Screen on page 5-17](#).

- 3 To exit the browser, press [X] (Close) and then press [Yes] in the exit confirmation screen.

NOTE

You can specify preferences such as the way the Internet browser screen is displayed. For details, refer to [Browser Environment on page 8-60](#).

Using the Browser Screen

The operations available in the Internet browser screen are shown below.

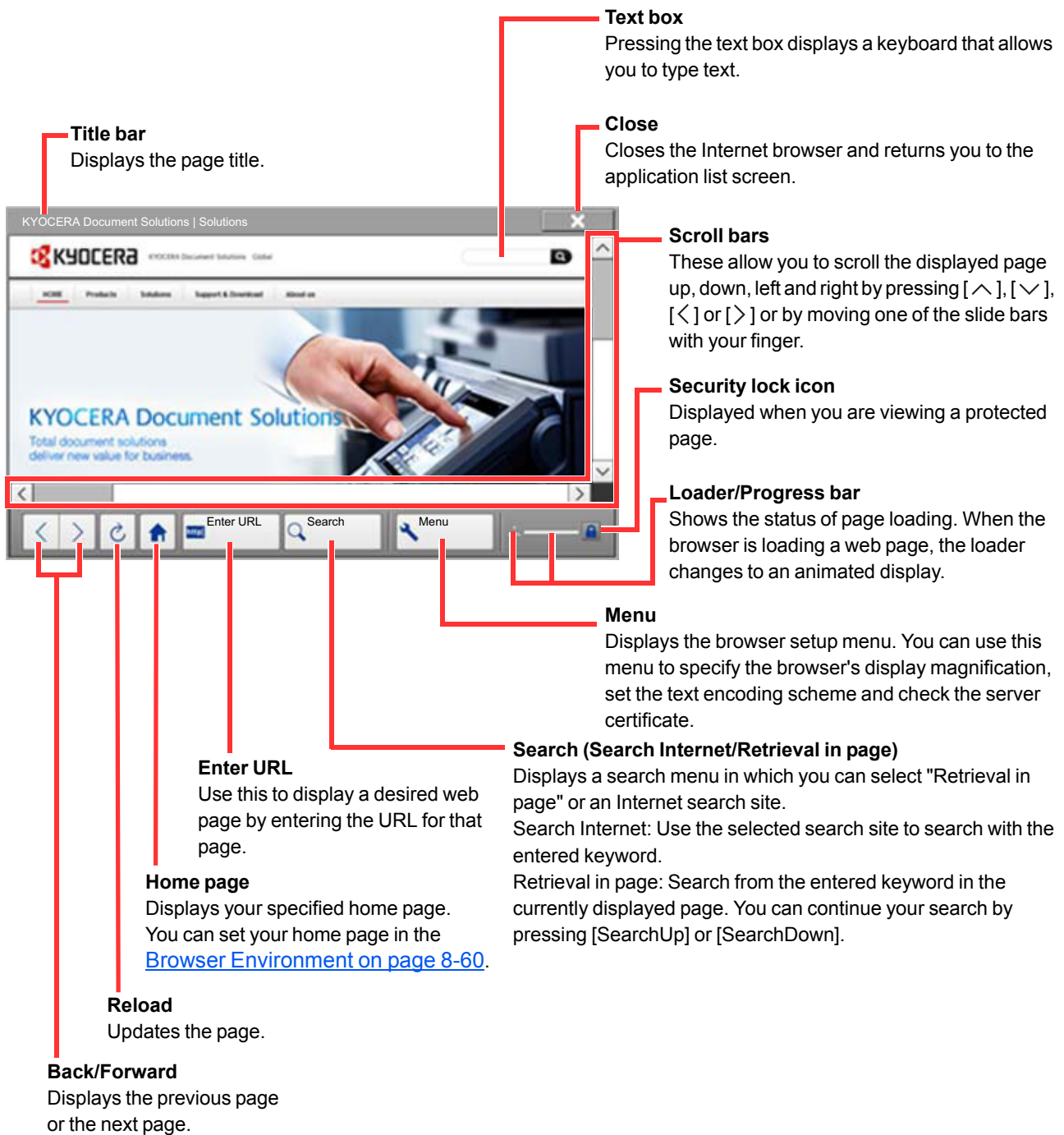

NOTE
Pressing the [Reset] key while the Internet browser is displayed will exit the browser and return you to the application list screen without displaying the browser exit.

Canceling Jobs

Follow the steps below to cancel any print or send job being executed.

Canceling Jobs

You can also cancel jobs by pressing the [Stop] key.

Printing jobs

- 1 Press the [Stop] key with the copy screen or send screen displayed.**
Canceling job screen appears. The current print job is temporarily interrupted.
- 2 To cancel printing, select [Cancel], and then press [Yes] in the confirmation screen.**

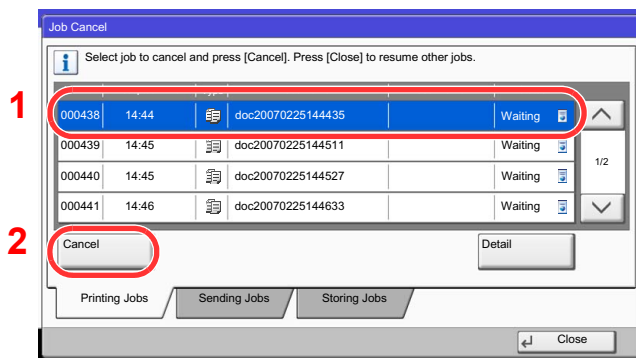

Sending jobs

- 1 Press the [Stop] key with the copy screen or send screen displayed.**

Job Cancel appears.



NOTE

Pressing the [Stop] key will not temporarily stop a job that you have already started sending.

- 2 To cancel printing, select [Cancel], and then press [Yes] in the confirmation screen.**



NOTE

If [Reserve Next Priority on page 8-29](#) is set to [Off], the Copying screen appears in the touch panel. In such case, pressing the [Stop] key or [Cancel] will cancel the printing job in progress.

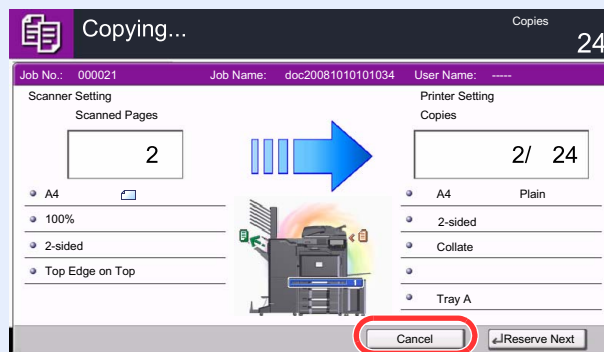

Canceling printing from a computer

To cancel a print job executed using the printer driver before the printer begins printing, do the following:

- 1 Double-click the printer icon () displayed on the taskbar at the bottom right of the Windows desktop to display a dialog box for the printer.
- 2 Click the file for which you wish to cancel printing and select [**Cancel**] from the "Document" menu.

Copying

Basic Operation

Follow the steps as below for basic copying.

1 Press [Copy] on the Home screen.



2 Place the originals.

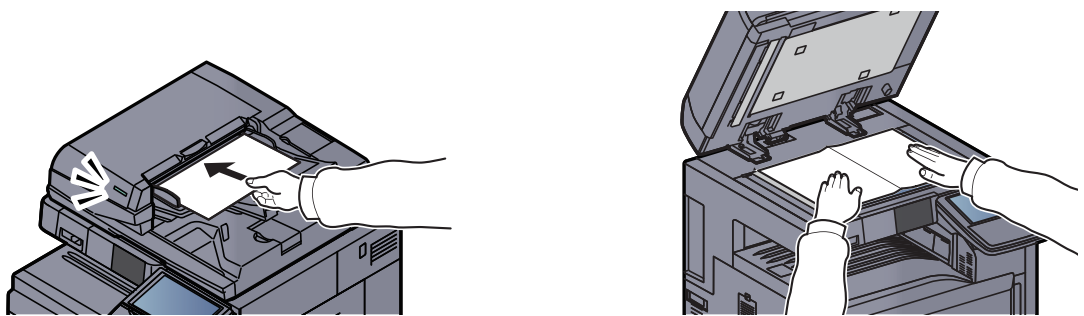

NOTE

For loading instructions, refer to [Loading Originals on page 5-2](#).

3 Select the functions.

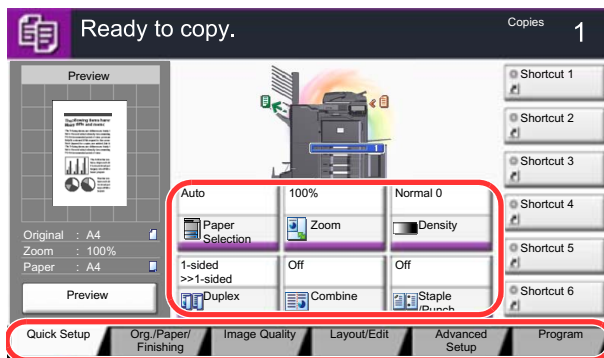

Select the copier functions to use.

Press tabs to display other functions.



[Copy \(page 6-2\)](#)

4 Use the numeric keys to enter the copy quantity.

Specify the desired number up to 999.

5 Press the [Start] key.

Copying begins.

Reserve Next

This function allows you to reserve the next job during printing. Using this function, the original will be scanned while the machine is printing. When the current print job ends, the reserved copy job is printed. The procedure differs depending on the Reserve Next Priority (refer to [Reserve Next Priority on page 8-29](#)).

If "Reserve Next Priority" is set to [On]

The Copy function default screen appears on the touch panel during printing.

- 1 Place the originals onto the machine for reserving copy, and configure the copy settings.**

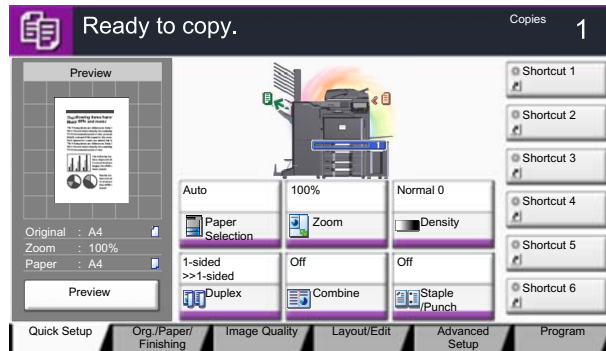

- 2 Press the [Start] key.**

The machine starts scanning the originals.

When the current print job ends, the reserved copy job is printed.

If "Reserve Next Priority" is set to [Off]

The Copying screen appears on the touch panel during printing.

- 1 Press [Reserve Next].**

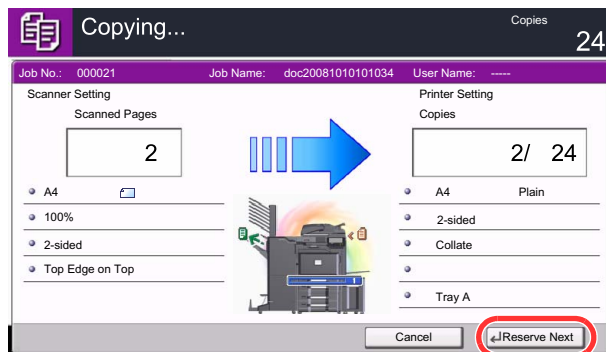

The default screen for copying appears.

- 2 Place the originals onto the machine for reserving copy, and configure the copy settings.**

- 3 Press the [Start] key.**

The machine starts scanning the originals.

When the current print job ends, the reserved copy job is printed.

Interrupt Copy

This function allows you to pause the current jobs in progress when you need to make copies immediately. When the interruption copy ends, the machine resumes the paused print jobs.

NOTE

- If the machine is left unused for 60 seconds in interrupt copy mode, interrupt copying is automatically cancelled and printing resumes. You can change the delay until interrupt copying is canceled. Change the delay as required.

 [Interrupt Clear Timer \(page 8-55\)](#)

- The interrupt copy function may be unavailable depending on the status of document finisher usage. In this case, try the priority override.

 [Priority Override \(page 6-54\)](#)

1 Configure the settings.

- 1 Press the **[Interrupt]** key.

Interrupt

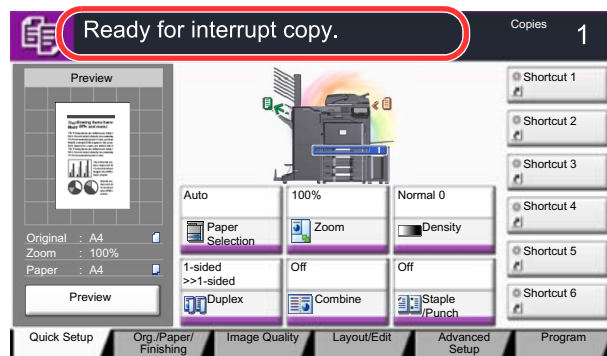

The current print job is temporarily interrupted.

- 2 Place the originals onto the machine for interrupt copy, and configure the copy settings.

2 Press the **[Start]** key.

Interrupt copying begins.

3 When interrupt copying ends, press the **[Interrupt]** key.

The machine resumes the paused print jobs.

Sending

This machine can send a scanned image as an attachment of an E-mail message or to a PC linked to the network. In order to do this, it is necessary to register the sender and destination (recipient) address on the network.

A network environment which enables the machine to connect to a mail server is required in order to send E-mail. It is recommended that a Local Area Network (LAN) be used to assist with transmission speed and security issues.

At the same time as you send a scanned image, you can also print the image or send it to the Job Box.

To use the transmission function, verify the following:

- Program the settings, including the E-mail setting on the machine.
- Use Command Center RX (the internal HTML web page) to register the IP address, the host name of the SMTP server, and the recipient.
- Register the destination in the Address Book or One Touch keys.
- Create a share folder in the destination computer, when a folder (SMB/FTP) is selected as the destination. Consult your network administrator concerning destination folder sharing settings.
- Create/Register a Custom Box (Using a custom box for sending).
- Select detailed transmission settings (to select a Document Box as the destination or to print and send the image at the same time).

Follow the steps below for basic sending. The following five options are available.

- Send as E-mail (E-mail Addr Entry): Sends a scanned original image as an E-mail attachment. (Refer to page 5-29.)

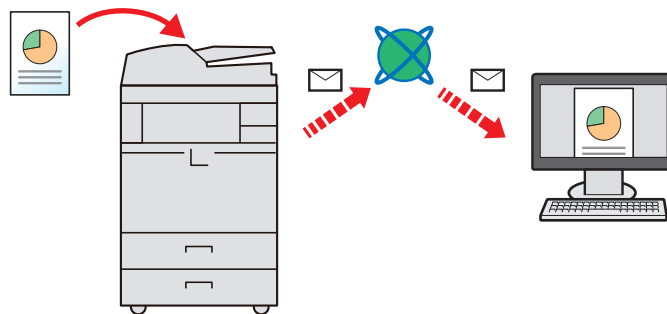

- Send to Folder (SMB): Stores a scanned original image in a shared folder of any PC. (Refer to page 5-32.)
- Send to Folder (FTP): Stores a scanned original image in a folder of an FTP server. (Refer to page 5-33.)

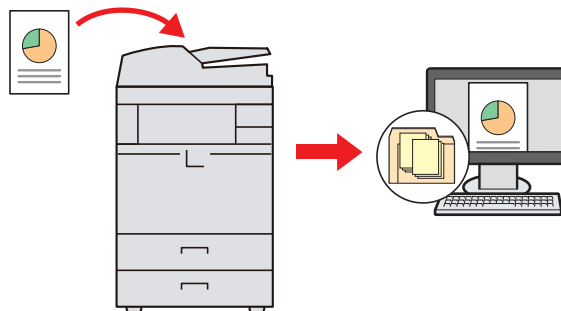

- Send to Custom Box: Sends a document stored in a document box on this machine. (Refer to page 5-58.)
- Image Data Scanning with TWAIN / WIA: Scan the document using a TWAIN or WIA compatible application program. (Refer to page 5-41.)

NOTE

Different sending options can be specified in combination. Refer to [Sending to Different Types of Destinations \(Multi Sending\) on page 5-36](#).

The fax function can be used when the optional FAX Kit has been installed. For details about this function, refer to the **FAX Operation Guide**.

Basic Operation

1 Press [Send] on the Home screen.



2 Place the originals.

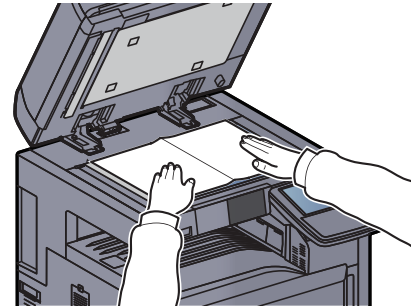
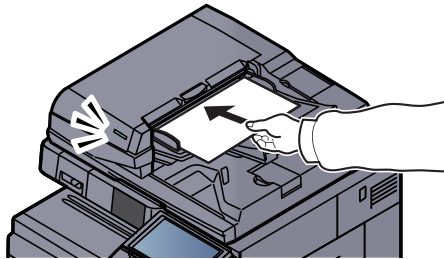

 [Loading Originals \(page 5-2\)](#)

3 Specify the destination.

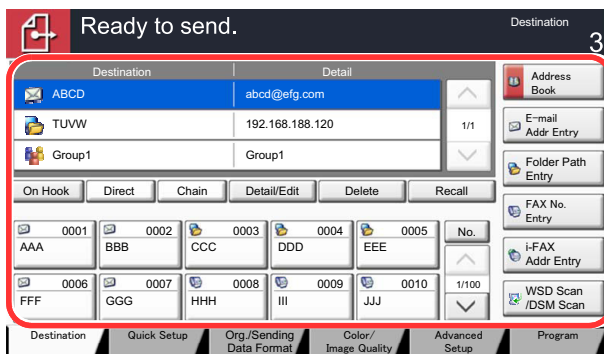

Select the destination to which to send an image.

 [Specifying Destination \(page 5-26\)](#)

4 Select the functions.

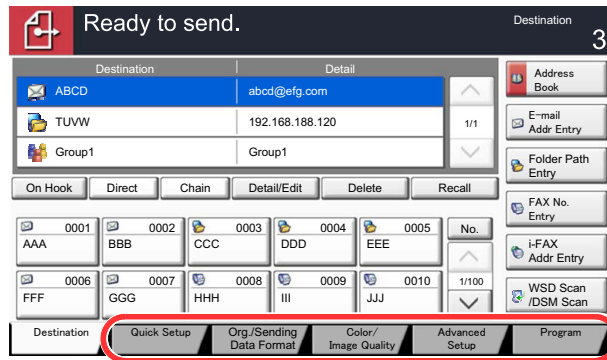

Press tabs to display other functions.

 [Send \(page 6-4\)](#)

5 Press the [Start] key.

Sending starts.

Specifying Destination

Select the destination using either of the following methods:

- [Choosing from the Address Book \(page 5-26\)](#)
- [Choosing from the One Touch Key \(page 5-28\)](#)
- [Choosing from the Speed Dial \(page 5-29\)](#)
- [Entering a New E-mail Address \(page 5-29\)](#)
- [Specifying a New PC Folder \(page 5-31\)](#)

NOTE

You can set the machine up so that the address book screen appears when you press the [**Send**] key. For details, refer to [Default Screen on page 8-9](#).
When the optional FAX Kit has been installed, you can specify the fax destination. Enter the other party number using the numeric keypad.

Choosing from the Address Book

Select a destination registered in the Address Book.

For more information about how to register destinations in the Address Book, refer to [Registering Destinations in the Address Book on page 3-46](#).

1 In the basic screen for sending, press [**Address Book**].

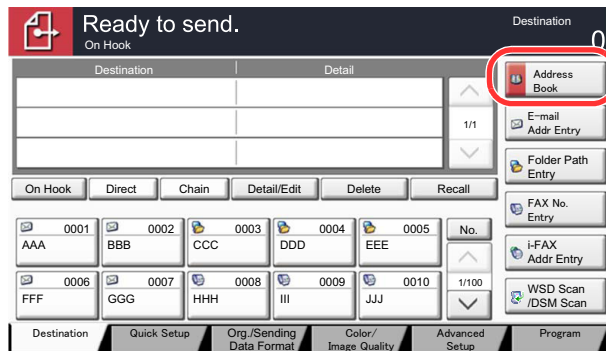

2 Select the destinations.

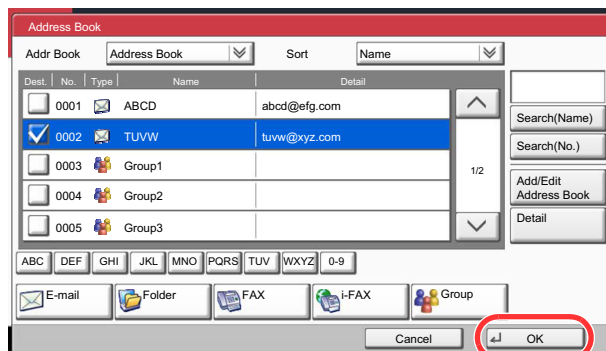

Press the checkbox to select the desired destination from the list. You may choose multiple destinations. The selected destinations are indicated by a checkmark in the check box. To use an address book on the LDAP server, select [Ext Address Book] from the "Addr Book" pull-down menu.

You can change the order in which the destinations are listed by selecting [Name] or [No.] from the "Sort".



NOTE

To deselect, press the checkbox again and remove the checkmark.

For details on the External Address Book, refer to **Command Center RX User Guide**.

Destination Search

Destinations registered in the Address Book can be searched. Advanced search by type or by initial letter is also available.

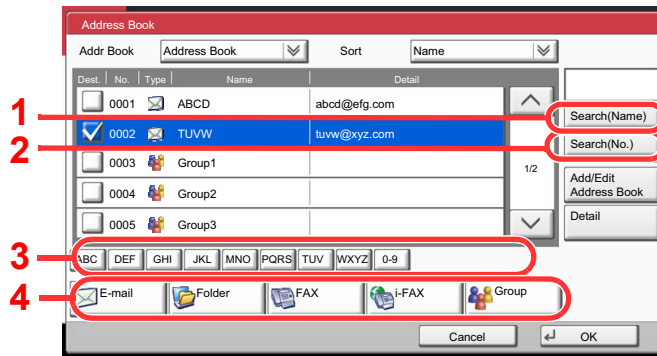

Keys used	Search type	Subjects searched
1	Search by name	Search by registered name.
2	Search by number	Search by registered address number.
3	Advanced search by initial letter	Advanced search by initial letter of registered name.
4	Advanced search by destination	Advanced search by type of registered destination (E-mail, Folder (SMB/FTP), FAX, i-FAX or Group). (FAX: Only when the optional FAX Kit is installed. i-FAX: Only when the optional Internet FAX Kit is installed.) You can set this function up so that destination types are selected when the address book is displayed. For details, refer to Narrow Down on page 8-53 .

The procedures for using the different search modes are explained below.

Search by name

Press [Search(Name)] and enter the required name.

Search by number

Press [Search(No.)] and enter the address number you wish to search.

Advanced search by destination

Press any of [E-mail], [Folder], [FAX], [i-FAX] or [Group]. The destinations registered by that type are displayed.

Advanced search by initial letter

Press the key for the required initial letter.

3 Accept the destination, and press [OK].

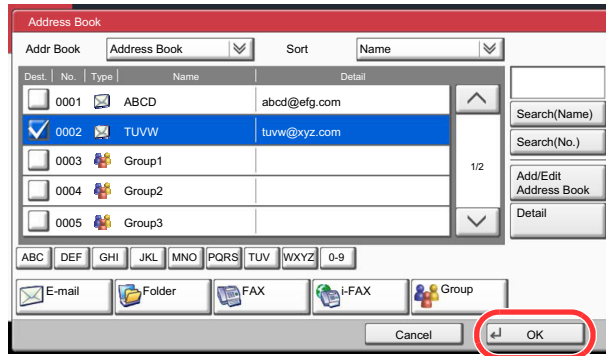

NOTE

To delete the destination, select the destination you want to delete and press [Delete]. You can set the default "Sort" settings. For details, refer to [Sort on page 8-53](#).

Choosing from the One Touch Key

Select the destination using the One Touch Keys.

In the basic screen for sending, press the One Touch Keys where the destination is registered.



NOTE

If the One Touch Keys for the desired destination is hidden on the touch panel, press [∨] or [∧] to scroll and view next or previous One Touch Keys. This procedure assumes that One Touch Keys have already been registered. Refer to [Adding a Destination on One Touch Key \(One Touch Key\) on page 3-54](#) for more information on adding One Touch keys.

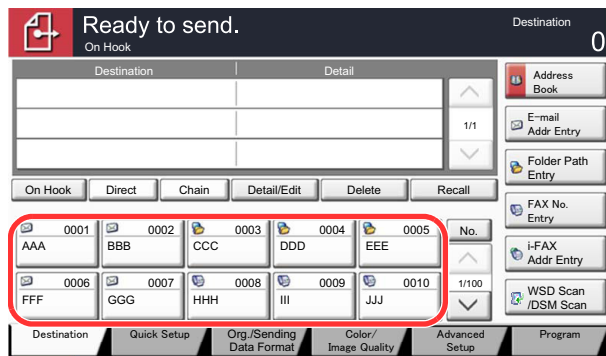

Choosing from the Speed Dial

Access the destination by specifying the 4-digit (0001 to 1000) One Touch Key number (speed dial).

In the basic screen for sending, press the [**Quick No. Search**] key or [No.] and use the numeric keys to enter the speed dial number in the numeric entry screen.

NOTE

if you entered the speed dial in 1 to 3-digit, press [OK].

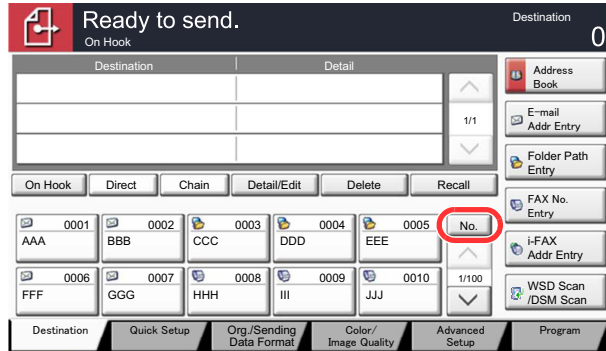

Entering a New E-mail Address

Enter the desired E-mail address.

NOTE

Access the Command Center RX beforehand and specify the settings required for sending E-mail. For details, refer to [E-mail settings on page 2-37](#).

1 In the basic screen for sending, press [**E-mail Addr Entry**].

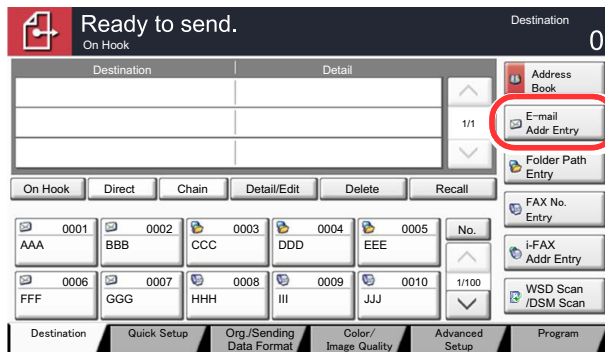

2 Enter destination E-mail address.

- 1 Press [E-mail Address], and enter the address.

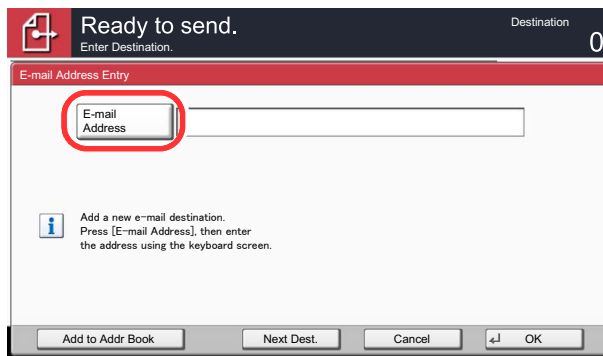

The maximum length of the E-mail address is 128 characters.

 [Entering Characters \(page 11-12\)](#)

- 2 Press [OK].

3 Press [OK].

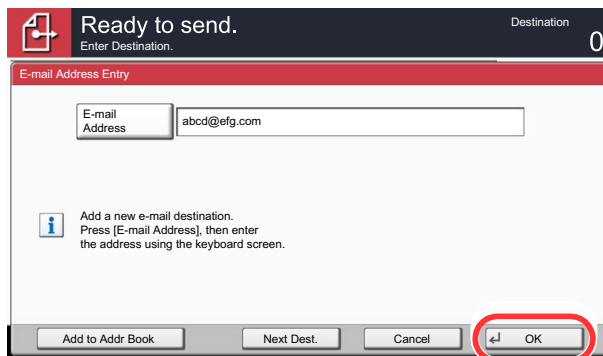

To enter multiple destinations, press [Next Destination] and enter the next destination. Up to 100 E-mail addresses can be specified.

You can register the entered mail address in the Address Book by pressing [Add to Address Book]. You can also replace the information for a previously registered destination.

 Destinations can be changed later. Refer to [Checking and Editing Destinations on page 5-34](#).

Specifying a New PC Folder

Specify either the desired shared folder on a computer or an FTP server as the destination.

NOTE

Refer to [Creating a Shared Folder. Making a Note of a Shared Folder on page 3-38](#) for details on how to share a folder.

Be sure that SMB Protocol or FTP in the Command Center RX is On. For details, refer to the **Command Center RX User Guide**.

1 In the basic screen for sending, press [Folder Path Entry].

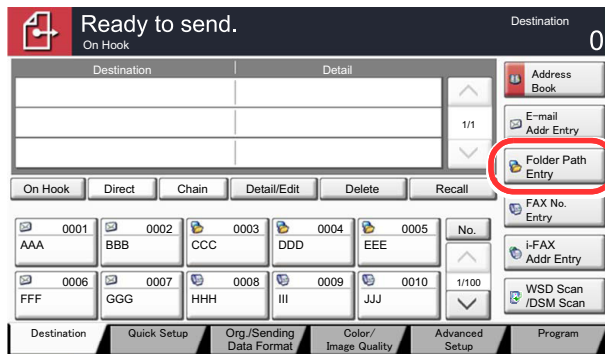

2 Enter the destination information.

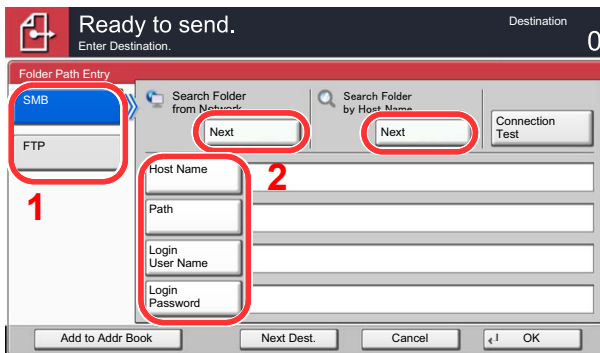

1 Press [SMB] or [FTP].

2 Enter the destination information.

Press the key of each item to first display the entry screen.

Enter the destination data and press [OK].



[Entering Characters \(page 11-12\)](#)

The table below explains the items to be entered.

For send to folder (SMB)

Item	Detail	Max. characters
Host Name *	Computer name	Up to 64 characters
Path	Share name For example: scannerdata If saving in a folder in the shared folder: "share name\folder name in shared folder"	Up to 128 characters
Login User Name	If the computer name and domain name are the same: User Name For example: james.smith If the computer name and domain name are different: Domain name\User name For example: "abcdnet\james.smith"	Up to 64 characters
Login Password	Windows logon password (Case sensitive.)	Up to 64 characters

* To specify a port number different from the default (445), enter using the format "Host name: port number" (Example: SMBhostname:140).
To enter the IPv6 address, enclose the address in brackets [].
(Example: [3ae3:9a0:cd05:b1d2:28a:1fc0:a1:10ae]:140)

To search for a folder on a PC on the network, press [Next] of "Search Folder from Network" or "Search Folder by Host Name".

If you selected "Search Folder from Network", you can enter the "Domain/Workgroup", and "Host Name" to search PCs on the network for the destination.

If you pressed "Search Folder by Host Name" you can search all PCs on the network for a destination.

A maximum of 500 addresses can be displayed. Select the host name (PC name) that you want to specify in the screen that appears, and press [Next]. The login user name and login password entry screen appears.

After you enter the login user name and login password name of the destination PC, the shared folders appear. Select the folder that you want to specify and press [Next]. The address of the selected shared folder is set.

Select the folder from the Search Results list.

For send to folder (FTP)

Item	Data to be entered	Max. characters
Host Name*	Host name or IP address of FTP server	Up to 64 characters
Path	Path to the receiving folder For example, "\User\ScanData". Otherwise the data will be saved in the home directory.	Up to 128 characters
Login User Name	FTP server login user name	Up to 64 characters
Login Password	FTP server login password (Case sensitive.)	Up to 64 characters

* To specify a port number different from the default (21), enter using the format "Host name: port number" (Example: FTPhostname:140).
To enter the IPv6 address, enclose the address in brackets [].
(Example: [3ae3:9a0:cd05:b1d2:28a:1fc0:a1:10ae]:140)

3 Check the status.

- 1 Check the information.
Change the delay as required.

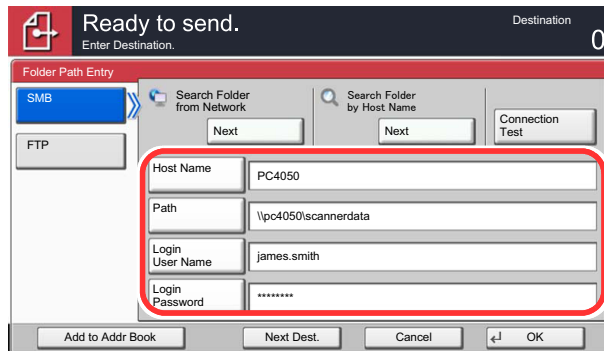

- 2 Press [Connection Test] to check the connection.

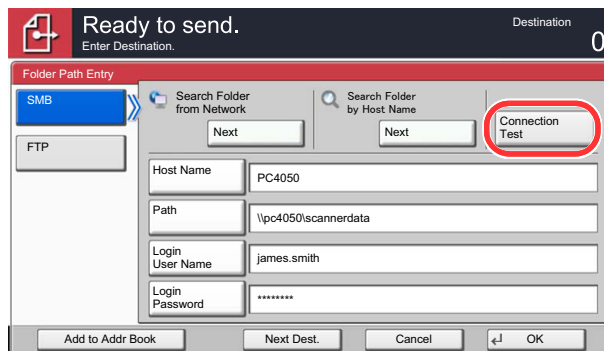

"Connected." appears when connection to the destination is correctly established. If "Cannot connect." appears, review the entry.

To enter multiple destinations, press [Next Destination] and enter the next destination. You can specify a combined total of up to 10 SMB and FTP destination folders.

You can register the entered information in the Address Book by pressing [Add to Address Book].

4 Accept the destination.

Press [OK].

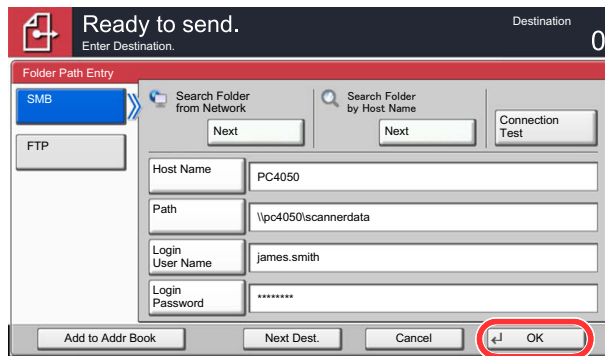

 Destinations can be changed later. Refer to [Checking and Editing Destinations on page 5-34](#).

Checking and Editing Destinations

Check and edit a selected destination.

1 Display the screen.

Referring to [Specifying Destination on page 5-26](#), specify the destination.

2 Check and edit the destination.

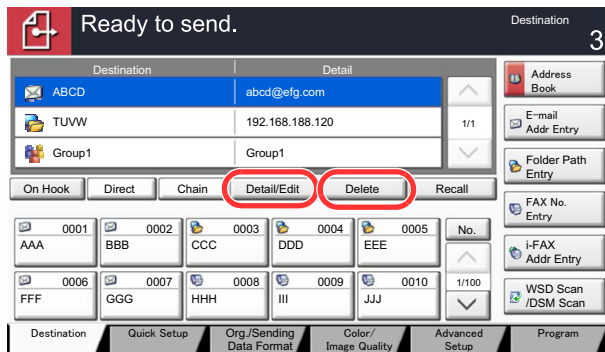

Select a destination and press [Detail/Edit] to check and edit it. Edit the destination as required.

Select a destination and press [Delete] to remove the destination from the list.



NOTE

When selecting [On] for Entry Check for New Destination ([Entry Check for New Dest. on page 8-29](#)), the confirmation screen appears. Enter the same host name and path again, and press [OK].

When selecting [On] for Destination Check before Send ([Dest. Check before Send on page 8-29](#)), the confirmation screen appears after pressing the [Start] key. For details, refer to [Confirmation Screen of Destinations on page 5-35](#).

Confirmation Screen of Destinations

When selecting [On] for Destination Check before Send ([Dest. Check before Send on page 8-29](#)), the confirmation screen of destinations appears after pressing the [Start] key.

Follow the steps below to confirm the destinations.

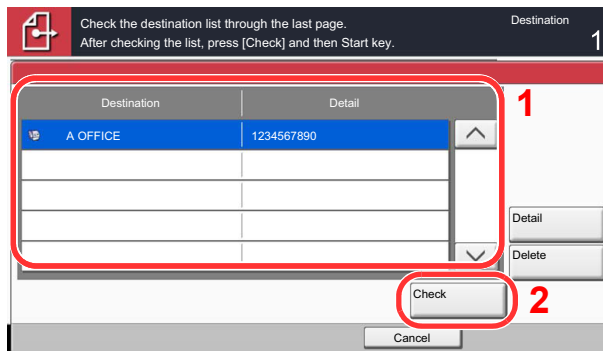

- 1 Press [∨] or [∧] to confirm all destination.

Pressing [Detail] shows the detailed information of the selected destination.

To delete the destination, select the destination you want to delete and press [Delete]. Press [Yes] in the confirmation screen. The destination is deleted.

To add the destination, press [Cancel] and then return to the destination screen.

- 2 Press [Check].



NOTE

Be sure to confirm all destination by displaying them on the touch panel. You cannot press [Check] unless you have confirmed all destination.

Sending to Different Types of Destinations (Multi Sending)

You can specify destinations that combine E-mail addresses, folders (SMB or FTP) and fax numbers*. This is referred to as Multi Sending. This is useful for sending to different types of destination (E-mail addresses, folders, etc.) in a single operation.

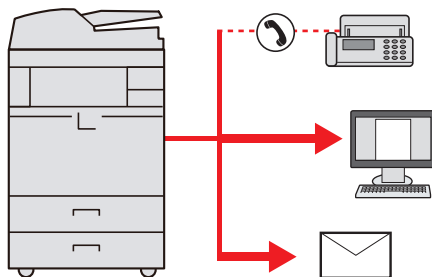

* Requires the optional FAX Kit.

No. of broadcast items

E-mail: Up to 100

Folders (SMB, FTP): Total of 10 SMB and FTP

FAX: Up to 500

i-FAX: Up to 100

Also, depending on the settings, you can send and print at the same time.

Procedures are the same as used in specifying the destinations of respective types. Continue to enter E-mail address or folder path so that they appear in the destination list. Press the **[Start]** key to start transmission to all destinations at one time.



NOTE

If the destinations include a fax, the images sent to all destinations will be black and white.

WSD Scan/DSM Scan

WSD Scan

WSD Scan saves images of originals scanned on this machine as files on a WSD-compatible computer.

 **NOTE**
To use WSD Scan, confirm that the computer used for WSD scanning and the machine is network-connected, and [WSD Scan on page 8-45](#) is set to [On] in the network settings.
For information on operating the computer, refer to the computer's help or the operation guide of your software.

Installing Driver Software (for Windows 7)

1 Click the **[Start]** button on the Windows, and then click **[Network]**.

In Windows 8, select the Desktop in the Start screen and click **[Libraries]**, and then **[Network]**.

 **NOTE**
When **[Network]** does not appear in the Start menu, perform the following procedure.

- 1 Right-click **[Start]** and click **[Property]** in the menu that appears.
- 2 Select the **[[Start] menu]** tab in the "Task bar and **[Start] menu properties**" screen, and click **[Customize]**.
- 3 When the "Customize **[Start] menu**" screen appears, select the "Network" check box and click **[OK]**.

2 Install the driver.

Right-click the machine's icon (Kyocera: XXX:XXX) and then click **[Install]**.

 **NOTE**
If the "User Account Control" window appears, click **[Continue]**.
If the "Found New Hardware" window appears, click **[Cancel]**.

During the installation, double-click the icon shown on the task bar to display the "Driver Software Installation" screen. When "Your devices are ready to use" is displayed on the **[Driver Software Installation]** screen, the installation is completed.

WSD scan

1 Press [Send] on the Home screen.



2 Place the originals.

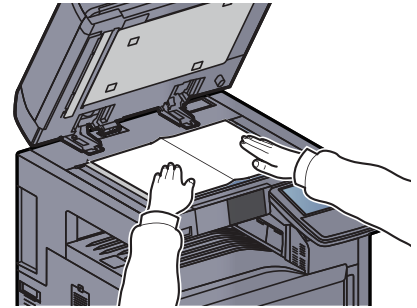
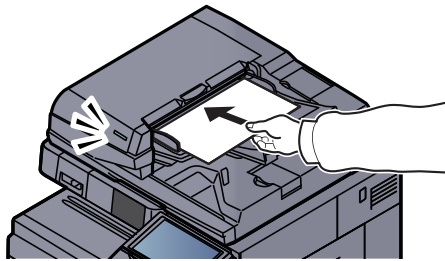

 [Loading Originals \(page 5-2\)](#)

3 Display the screen.

Press [WSD Scan/DSM Scan].

If [DSM Scan on page 8-45](#) is set to [Off] in the network settings, press [WSD Scan] and go to step 4.

4 Scan the originals.

Procedure using this machine

1 Select [From Operation Panel] and press [Next].

2 Select the destination computer and press [OK].

Press [Reload] to reload the computer list.

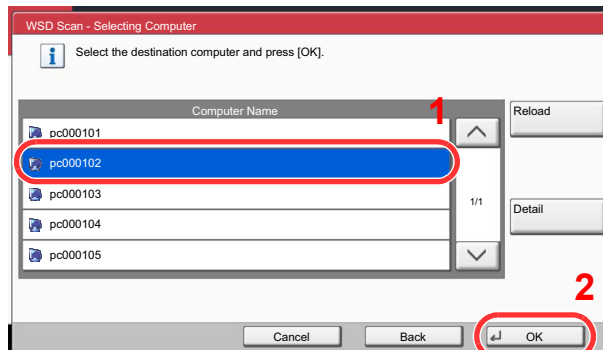

You can view information on the selected computer by pressing [Detail].

- 3 Set the type of original, file format, etc., as desired.
- 4 Press the **[Start]** key.
Sending begins and the software installed on the computer is activated.

Procedure from Your Computer

- 1 Press **[From Computer]** and press **[Next]**.
- 2 Use the software installed on the computer to send the images.

DSM Scan (Windows Server 2008 R2 or Windows Server 2012 Only)

A scanned document can be automatically saved in any format or sent to any destination by reading a scan process from Active Directory.

NOTE

If you are performing DSM scan, check the items below.

- The machine is connected to an Active Directory on the network that the scan process can reference.
- "DSM Scan", "LDAP" and "HTTP" are set to **[On]** in [Protocol Settings \(page 8-45\)](#) in Network.
- "SSL" is set to **[On]** in [Security Settings \(page 8-46\)](#) in Network.
- **[Network Authentication]** is set in [User Login \(page 9-4\)](#).

If the Active Directory that the scan process can reference is not on the network authentication server, DSM must be set in Command Center RX. For details, refer to the **Command Center RX User Guide**.

1 Press **[Send]** on the Home screen.



NOTE

Depending on the settings, the address book screen may appear. In this event, press **[Cancel]** to display the screen for sending.

2 Place the originals.

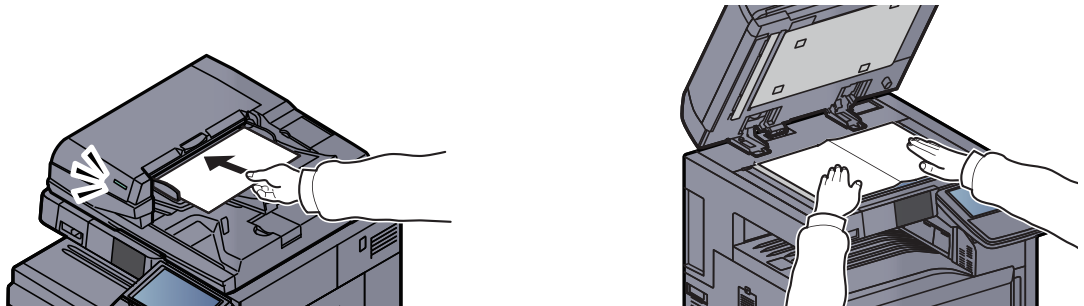

 [Loading Originals \(page 5-2\)](#)

3 Press [WSD Scan/DSM Scan].

If [WSD Scan on page 8-45](#) is set to [Off] in the network settings, press [DSM Scan] and go to step 5.

4 Select [DSM Scan] and press [Next].

5 Select the scan process to be used and press [OK].

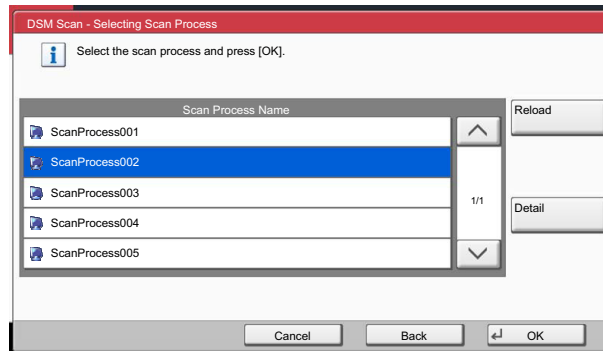

Press [Reload] to reload the computer list.

To check the settings, press [Detail].

6 Change the settings and add destinations as needed.

Only E-mail addresses can be added as destinations.

In the send base screen, press [Detail/Edit], [Destination], and then [Address Book] or [E-mail Addr Entry], and add a destination.

In some scan processes, it may not be possible to change settings or add destinations.

7 Press the [Start] key.

Sending starts.

Scanning using TWAIN

This section explains how to scan an original using TWAIN. The machine's TWAIN/WIA can be used for two types of scanning: scanning a document placed in the machine, and scanning a document that has been stored in a custom box.

The procedure for scanning using the TWAIN driver is explained as an example. The WIA driver is used in the same way.

Scanning a document placed in the machine

1 Display the screen.

- 1 Activate the TWAIN compatible application software.
- 2 Select the machine using the application and display the TWAIN dialog box.



NOTE

For selecting the machine, see the Operation Guide or Help for each application software.

2 Configure the scan settings.

Select scanning settings in the TWAIN dialog box that opens.

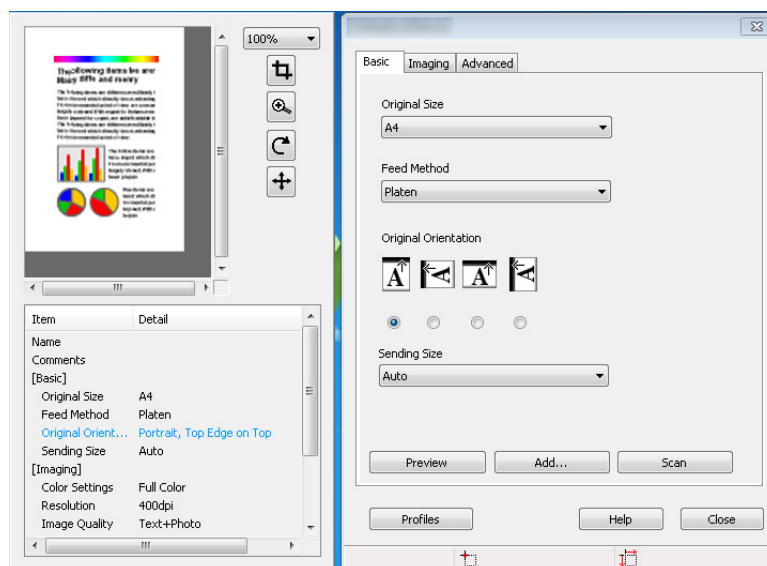

The settings that appear in the TWAIN dialog box are as follows.

Item		Detail
Basic	Original Size	This setting sets the size of the scan area. The available sizes vary based on the scanner model and the size of the original.
	Feed Method	This setting specifies the feed method of the original. Select the feed method from the list.
	Original Orientation	This setting specifies the orientation of the original.
	Sending Size	This setting specifies the image size. The available sizes vary based on the scanner model and the scan area selected in the preview panel.
Imaging	Color Settings	This setting specifies the type of color for the image.
	Resolution	This setting specifies the dpi (dots per inch), or sharpness, for the image.
	Image Quality	This setting specifies the overall image quality. Make sure your selection matches the original that you are scanning.
	Exposure Level	This setting specifies the sharpness and clarity of the image. If the "Auto" check box is selected, then the slider bar and edit box are unavailable, and the exposure level is automatically set to the default setting.
	Contrast	This setting specifies the contrast between light and dark areas of the image. This feature cannot be used when [Black & White] is selected in the [Color Settings].
Advanced	Reverse Image	This setting scans images like a photo negative, reversing the black and white areas of the image.
	Prevent Bleed-through	This setting prevents the image on one side of the paper from showing through to the other side when scanned.
Scan Profiles		This is used to check current settings and store frequently used settings. When the [Configuration] button is clicked, a setting screen opens with buttons for [Add], [Edit], and [Delete].
	Add	The current settings can be saved as a Scan Profile.
	Edit	The name and comments of the selected Scan Profile can be changed.
	Delete	Delete saved Scan Profiles.

3 Place the originals.

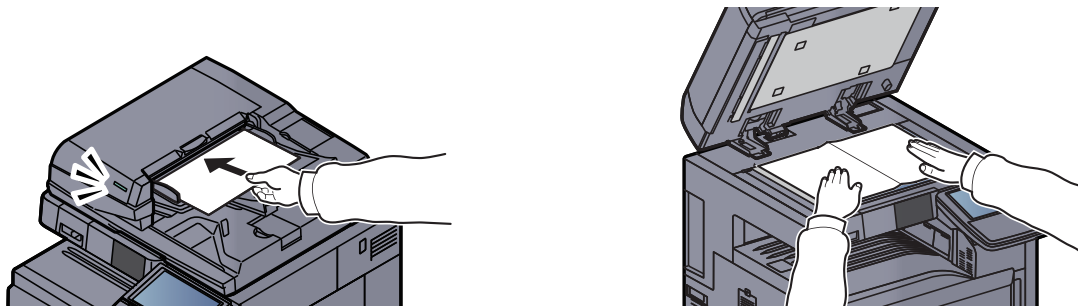

 [Loading Originals \(page 5-2\)](#)

4 Scan the originals.

Click the [Scan] button. The document data is scanned.

Scanning a document stored in a custom box



NOTE

To scan a document stored in a custom box, select a model name with (Box) from "Model" in the TWAIN driver settings screen.

1 Display the TWAIN dialog box.

- 1 Activate the TWAIN compatible application software.
- 2 Select the machine using the application and display the TWAIN dialog box.



NOTE

For selecting the machine, see the Operation Guide or Help for each application software.

2 Display list of documents.

- 1 Select the Custom Box containing the document file to be scanned from [Box List].

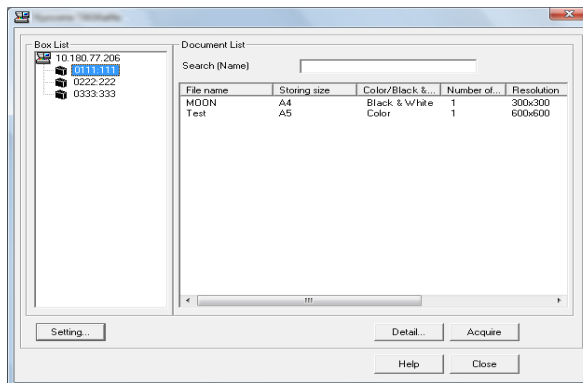

If a password has been set for the box, the password entry screen appears. Enter the password and click the [OK] button. When you select a box, the document files in the Custom Box appear in [Document List].

- 2 Set how to display the document data. Click the [Setting] button to select each item.

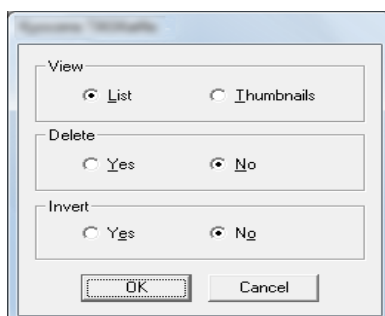

Item	Detail
View	Change the display in the Document List field to List or Thumbnails.
Delete	After scanning the document data, delete the data from the Custom Box.
Invert	Invert the document data color to start scanning.

- 3 Click [OK] button.

3 Scan the originals.

- 1 Select the document data to be scanned from [Document List].

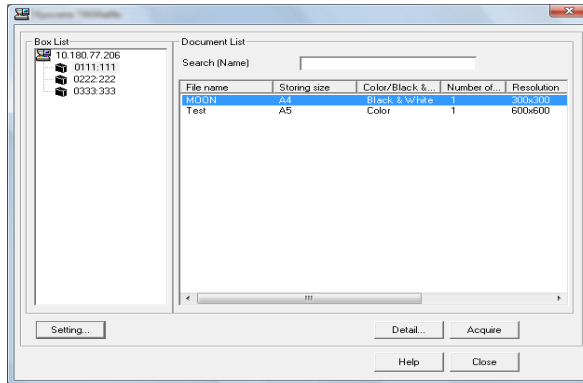

Enter the document data name in the Search (Name) to find the data having the same document data name or the document data name with the same beginning.

Click the [Detail] button to display the selected document data. When the document data includes multiple pages, select the checkbox beside the pages you want to scan. The selected pages will be scanned.

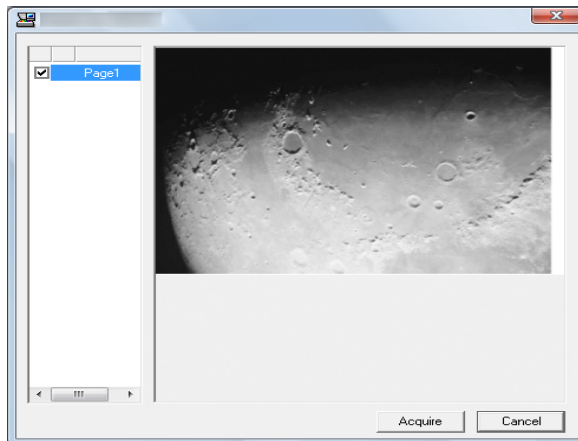

NOTE

In this case, the scanned page or the selected document data will not be deleted from the Custom Box.

- 2 Click the [Acquire] button.
The document data is scanned.

Scanning with FMU Connection

"FMU Connection" is installed on the machine as a standard application.

FMU Connection can be used to scan an original according to the settings configured with "File Management Utility" on the provided DVD, and save the image data and scanning information on a specified server or in a specified folder. Unlike regular transmission functions, this application lets you use metadata such as the scan date and time and the data format.

NOTE

The first time you use FMU Connection, you must enable it in System Menu. For details, refer to [Application on page 8-60](#).

To use FMU Connection, you must install File Management Utility on your computer and configure settings for the multifunction machine to be used, scanning conditions, and the file save location. To install File Management Utility, refer to [Installing Software on page 2-13](#).

For information on using File Management Utility, see **File Management Utility User Guide** on the DVD.

Using FMU Connection to scan an original

- 1 Make sure that File Management Utility is running on the computer (or server) on which File Management Utility is installed.**
- 2 Place the original.**
- 3 Press [FMU Connection].**
FMU Connection starts.
- 4 Follow the on-screen instructions to enter the necessary information and press [Next].**
- 5 When the scan settings screen appears, press each item and configure the necessary settings.**
The features that can be set depend on File Management Utility.
- 6 Press the [Start] key.**
Sending starts.

How to use the FAX Function

By installing the optional FAX Kit in the machine you can use the fax function. For details, refer to the **FAX Operation Guide**.

What is Document Box?

Document Box contains four types of component boxes which provide the following functions.

The following types of document boxes are available.

Custom Box (page 5-53)

Custom Box is a component box which you can create within the Document Box and store data for later retrieval. You can create or delete a Custom Box, and manipulate data in various ways as described below:



[Creating a New Custom Box \(Add/Edit Box\) \(page 5-53\)](#)

[Storing Documents \(Store File\) \(page 5-56\)](#)

[Printing Documents \(Print\) \(page 5-57\)](#)

[Sending Documents \(Send\) \(page 5-58\)](#)

[Editing Documents \(page 5-60\)](#)

[Deleting Documents \(page 5-64\)](#)

Job Box

Job Box is a generic name for the "Private Print/Stored Job Box", "Quick Copy/Proof and Hold Box", "Repeat Copy Box", and "Form for Form Overlay Box". These Job Boxes cannot be created or deleted by a user.



NOTE

You can set up the machine so that temporary documents in job boxes are automatically deleted. For details, refer to [Deletion of Job Retention on page 8-34](#).

Private Print/Stored Job Box (page 4-14)

In Private Printing, you can specify that a job is not to be printed until you operate the machine. When sending the job from the application software, specify a 4-digit access code in the printer driver. The job is released for printing by entering the access code on the operation panel, ensuring confidentiality of the print job. The data will be deleted upon completion of the print job or after the main power switch is turned off.

In Stored Job, the print data sent from the application is saved to the machine. You can set up an access code as necessary. If you set up an access code, enter the access code when printing. Print data will be stored in the hard disk after printing. This will allow printing of the same print data repeatedly.

Quick Copy/Proof and Hold Box (page 4-16)

Quick Copy feature facilitates additional prints of a document already printed. Activating Quick Copy and printing a document using the printer driver allow the print data to be stored in the Quick Copy Job Box. When additional copies are required, you can reprint the required number of copies from the operation panel. By default, up to 32 documents can be stored. When power is turned off, all stored jobs will be deleted.



NOTE

When you attempt to store documents in excess of the above maximum, the oldest document data will be overwritten by the latest document data.

The Proof and Hold feature produces only a single proof print of multiple-print job and holds printing of the remaining copies. Printing a multiple-print job in Proof and Hold using the printer driver allows only a single copy to be printed while maintaining the document data in the Job Box. To continue to print the remaining copies, use the operation panel. You can change the number of copies to print.

Repeat Copy Box (page 5-66)

Repeat Copy feature stores the copied original document data in the Job Box and allows you to print additional copies later. By default, up to 32 documents can be stored. When power is turned off, all stored jobs will be deleted.



NOTE

Repeat Copy function is not available when the optional Data Security Kit is installed.

Form for Form Overlay Box (page 5-65)

Image Overlay feature copies the original document overlaid with a form or image. This Job Box is used to store the forms or images for overlaying.

Removable Memory Box (page 5-68)

A USB memory stick can be connected to the USB port (A1) on the machine to print a saved PDF file. You can print PDF data directly from the USB memory without a PC. Image files scanned using this machine can also be saved to USB memory in the PDF, TIFF, JPEG, XPS or high compression PDF format (Scan to USB).

Fax Box

Fax Box stores the fax data received. For details, refer to the **FAX Operation Guide**.

Basic Operation for Document Box

This section explains basic operations for document boxes, using examples where tasks are carried out with custom boxes.



NOTE

In the following explanation, it is assumed that user login administration is enabled. For details on User Logon privileges, refer to [Editing Custom Box on page 5-55](#).

Box List

Listing the boxes by number in ascending/descending order.

Listing the boxes by name in alphabetical order.

Listing the boxes by owner in alphabetical order.

A box can be searched for by Box Name.

A box can be searched for by Box No.

Registers new boxes and checks, modifies or deletes box information.

Saves the document in the selected box.

Opens the selected box.

Displays the details for the selected box.

No.	Name	Owner	Used
0001	SALES	Anonymous	63 MB

Buttons: Store File, Detail, Open

Search fields: Search(Name), Search(No.)

Buttons: Add/Edit Box

Document List

The document list is a list of the documents stored in the custom box. Documents can be listed either by name or as thumbnails. The list can be used as shown below.

List

Listing the documents by name in alphabetical order.

Listing the documents by time of update in ascending/descending order.

Selecting more than one document at a time.

Selecting documents by checking checkboxes.

Switches between list display and thumbnail display.

Listing the documents by size in ascending/descending order.

Select a document in the Document List and press [Page Selection] to display the selected document.

Select a document in the Document List and press [Detail] to display the details for the selected document.

Previews the selected document.

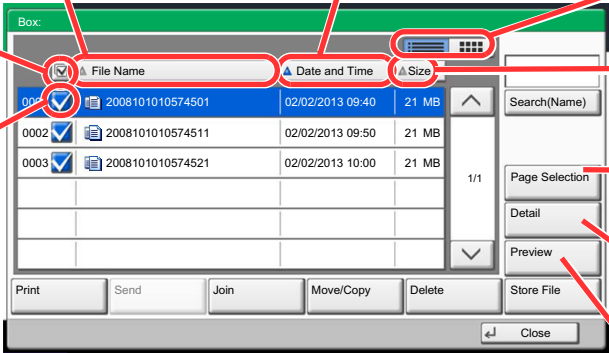

File Name	Date and Time	Size
2008101010574501	02/02/2013 09:40	21 MB
0002 2008101010574511	02/02/2013 09:50	21 MB
0003 2008101010574521	02/02/2013 10:00	21 MB

Thumbnail

Selecting more than one document at a time.

Highlighting a document to display its details with [Detail].

Selecting documents by checking checkboxes.

Prints, sends, joins, moves, copies or deletes the selected documents.

Saves the document in the open box.

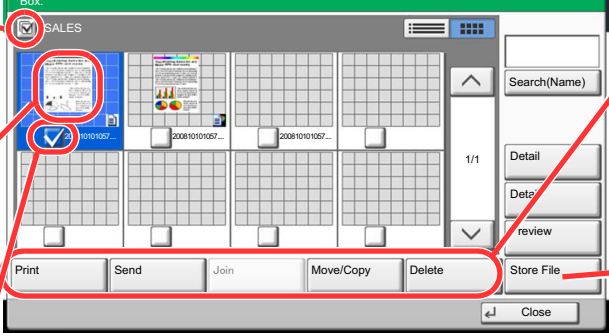

NOTE

You can select multiple documents by pressing the respective document checkboxes. However, note that you cannot select multiple documents when you are sending documents.

Viewing/Editing Box Details

You can check and modify box information.

Use the procedure below.

- 1 Press [Add/Edit Box] in the box list screen.**
- 2 Highlight the box whose box details you wish to check or edit and press [Detail/Edit].**

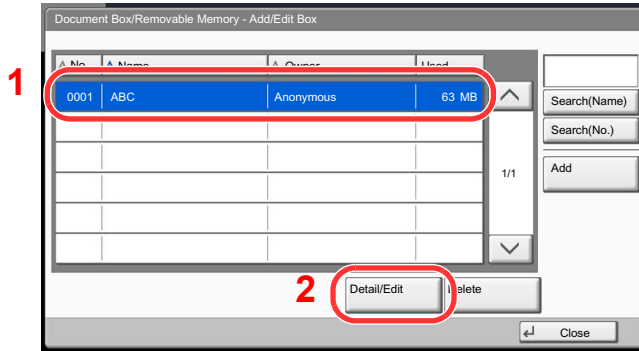

NOTE

If a custom box is protected by a password, enter the correct password.

- 3 Check the box details.**

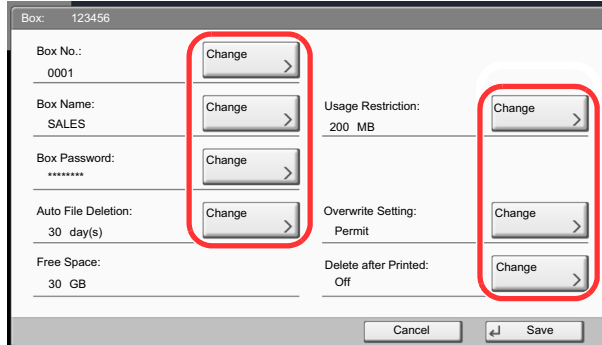

To edit details, press [Change] of the detail you wish to edit. Edit the detail as desired and press [OK].

- 4 If you have changed the details, press [Save] and then press [Yes] in the confirmation screen.**

If you do not change the details, press [No].

- 5 Press [Close].**

The display returns to the default Document Box screen.

Previewing Documents/Checking Document Details

You can use this function to preview the documents stored in a document box or display the document details for checking.

1 Select (highlight) a document to preview and then press [Preview] or [Detail].

2 Preview the document or check the document details.

The operations available in the preview screen are shown below.

When you have zoomed in, you can use these keys to move the displayed area.

Zoom out. Zoom in.

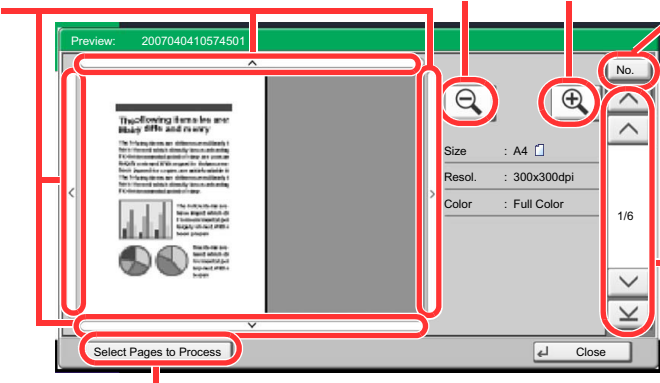

In multiple-page documents, you can change pages by entering the desired page number.

In multiple-page documents, you can use these buttons to change pages.

Press to select any page of the open document and print, send or copy to removable memory.

[Selecting a page \(page 5-52\)](#)



NOTE

The preview display can be controlled by moving your finger(s) on the touch panel.



[Using the Preview Screen \(page 3-10\)](#)

3 Confirm the document(s) and press [Close].

Selecting a page

When printing, sending, or copying a document within a Custom Box, you can specify any pages at will. Press [Page Selection] in the document list screen of the Custom Box, or [Select Pages to Process] in the Preview screen, to display the page selection screen.

Select the pages you want to work with, and press [Print], [Send], or [Copy to Memory].

Selecting more than one document at a time. Displaying the number of pages selected.

Highlighting the selected document.

Selecting documents by checking checkboxes.

Selected pages can be printed, sent, or copied to custom box.

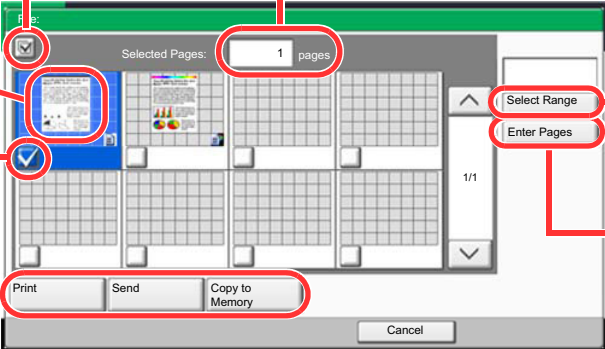

The screenshot shows a page selection interface. At the top, it says 'Selected Pages: 1 pages'. Below this is a grid of document thumbnails. One thumbnail is highlighted in blue. A red circle highlights a checkbox in the top-left corner of the grid. Another red circle highlights a checkbox in the top-left corner of the selected document thumbnail. At the bottom of the grid, there are three buttons: 'Print', 'Send', and 'Copy to Memory'. To the right of the grid, there are two buttons: 'Select Range' and 'Enter Pages'. A 'Cancel' button is at the bottom center. Red lines connect the text annotations to the corresponding elements in the screenshot.

You can specify a range of selection by pressing [Select Range].

You can specify the pages you want to select by pressing [Enter Pages].



[Printing Documents \(Print\) \(page 5-57\)](#)

[Sending Documents \(Send\) \(page 5-58\)](#)

[Moving a Document/Copying a Document \(Move/Copy\) \(page 5-60\)](#)

Using a Custom Box

Creating a New Custom Box (Add/Edit Box)

 **NOTE**

If user login administration is enabled, you can only change the settings by logging in with administrator privileges. The factory default login user name and login password are set as shown below.

Model Name	Login User Name	Login Password
3501i	3500	3500
4501i	4500	4500
5501i	5500	5500

If user login administration is enabled, log in with administrator privileges to perform the following operations. They cannot be performed with user privileges.

- Creating a box
- Deleting a box of which owner is another user.

1 Press [Custom Box] on the Home screen.



2 Press [Add/Edit Box].

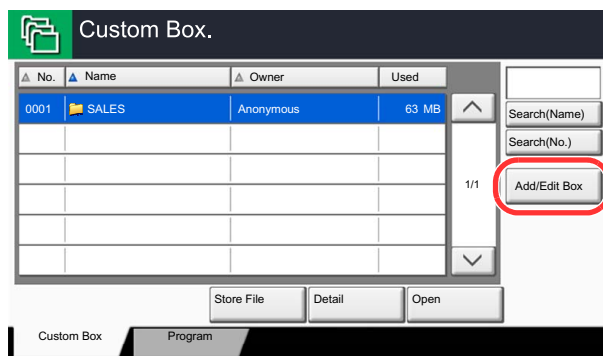

3 Select [Add].

4 Press [Change] for each item.

5 Enter the information and then press [OK].

The table below lists the items to be set.

Item	Description
Box No.	Enter the box number by pressing [+], [-] or number keys. The box number can be from 0001 to 1000. A Custom Box should have a unique number. If you enter 0000, the smallest number available will be automatically assigned.
Owner*	Set the owner of the box. Select the owner from the user list that appears.
Box Name	Enter a box name consisting of up to 32 characters. Refer to Entering Characters on page 11-12 for details on entering characters.
Usage Restriction	To preserve the hard disk capacity, the storage capacity for a box can be restricted. To enable a capacity restriction enter a value for the storage capacity of the Custom Box in megabytes by pressing [-], [+] or number keys. You can enter a limit between 1 and 30,000 (MB).
Box Password	User access to the box can be restricted by specifying a password to protect the box. Entering a password is not mandatory. Enter the same password of up to 16 characters in both [Password] and [Confirm Password].
Permission*	Select whether to share the box.
Auto File Deletion	Automatically deletes stored documents after a set period of time. Press [On] to enable automatic deletion and then use [+] and [-] or the numeric keys to enter the number of days for which documents are stored. You can enter any number between 1 and 31 (day(s)). To disable automatic file deletion, press [Off].
Overwrite Setting	Specifies whether or not old stored documents are overwritten when new documents are stored. To overwrite old documents, press [Permit]. To retain old documents, press [Prohibit].
Free Space	Displays the free space on the box.
Delete after Printed	Automatically delete a document from the box once printing is complete. To delete the document, press [On]. To retain the document, press [Off].

* Displayed when the user login administration is enabled.

6 Check the details you have entered and then press [Save].

The Custom Box is created.

Editing Custom Box

- 1 Referring to [Creating a New Custom Box \(Add/Edit Box\) on page 5-53](#), display the screen for editing the custom box.**
- 2 Select the box you want edit, and press [Detail/Edit].**



NOTE

When you have logged in as a user, you can only edit the box whose owner is set to that user.
When you have logged in as administrator, you can edit all boxes.

- 3 Edit the custom box.**

When user login administration is enabled, the settings that can be changed varies depending on the privileges of the logged in user.

Privileges	Settings that can be changed
Administrator	Box No.
	Owner
	Box Name
	Usage Restriction
	Box Password
	Permission
	Auto File Deletion
	Overwrite Setting
	Delete after Printed
User	Box Name
	Box Password
	Permission
	Auto File Deletion
	Overwrite Setting
	Delete after Printed

For details, refer to [Creating a New Custom Box \(Add/Edit Box\) on page 5-53](#).

Deleting Custom Boxes

- 1 Referring to [Creating a New Custom Box \(Add/Edit Box\) on page 5-53](#), display the screen for editing the custom box.**
- 2 Select the box you want delete, and press [Delete].**

If the box that you want to delete has a password, enter the correct password.



NOTE

When you have logged in as a user, you can only delete the box whose owner is set to that user.
When you have logged in as administrator, you can delete all boxes.

Storing Documents (Store File)

The procedure for storing documents in a custom box is explained below.

1 Press [Custom Box] on the Home screen.



2 Place the originals.

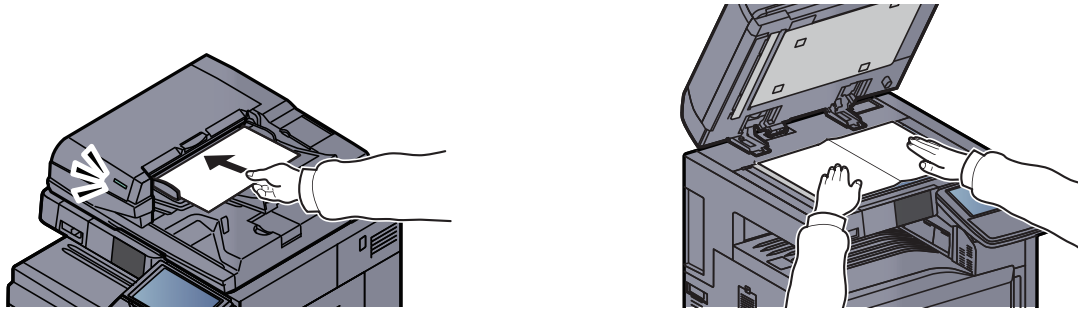

3 Select the box where the document will be stored and then press [Store File].

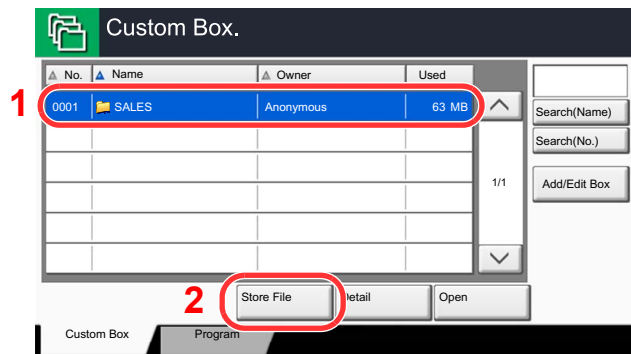

4 Select the type of originals, scanning density, etc., as necessary.

For the features that can be selected, refer to [Custom Box \(Store File, Printing, Send\) \(page 6-6\)](#).

5 Press the [Start] key.

The original is scanned and the data is stored in the specified Custom Box.



NOTE

Enter up to 32 characters as the file name.

Printing Documents (Print)

The procedure for printing documents in a custom box is explained below.

1 Display the screen.

- 1 Press [Custom Box] on the Home screen.

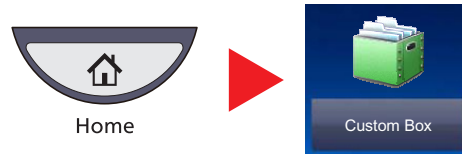

- 2 Select the box containing the document you want to print.
- 3 Press [Open].



NOTE

If a custom box is protected by a password, enter the correct password.

2 Print the document.

- 1 Select the document you wish to print by checking the checkbox.

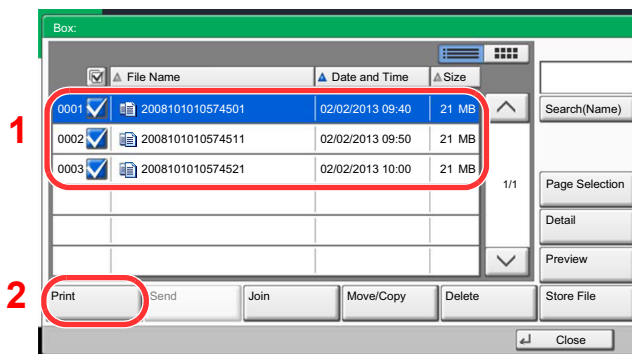

The document is marked with a checkmark.



NOTE

To deselect, press the checkbox again and remove the checkmark.

- 2 Press [Print].

3 Set the paper selection, duplex printing, etc., as desired.

For the features that can be selected, refer to [Custom Box \(Store File, Printing, Send\) \(page 6-6\)](#).

If a document stored from a computer is selected, the print settings selection screen appears.

- To use the settings used at the time of printing (when the document was saved), press [Print As Is]. Press [Start Print] to start printing.
- To change the print settings, press [Print after Change Settings] and change the print settings.
After a document saved in the machine is selected, the [Use File Settings] key may appear in the setting screen for the feature to be used.
- To use the settings saved with the document, press [Use File Settings].
- If you need to change the print settings, press [Print after Change Settings].

4 Press the [Start] key. Printing of the selected document begins.

Sending Documents (Send)

The procedure for sending documents in a custom box is explained below.

1 Display the screen.

- 1** Press [Custom Box] on the Home screen.

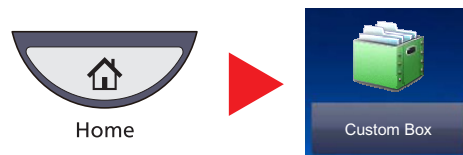

- 2** Select the box containing the document you want to send.
3 Press [Open].



NOTE

If a custom box is protected by a password, enter the correct password.

2 Send the document.

- 1** Select the document you wish to send by checking the checkbox.

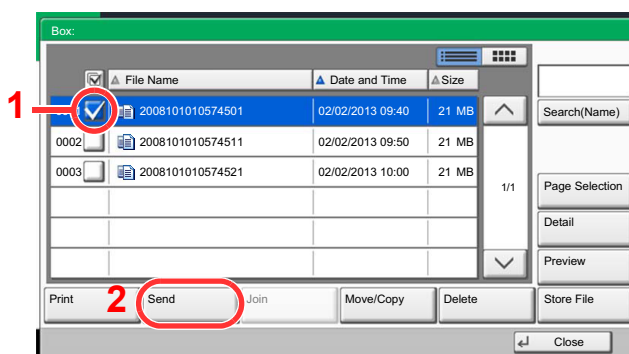

The document is marked with a checkmark.



NOTE

You cannot select and send multiple documents.
To deselect, press the checkbox again and remove the checkmark.

2 Press [Send].

The screen for sending appears.



NOTE

Depending on the settings, the address book screen may appear.

3 Set the destination.



NOTE

For more information on selecting destinations, refer to [Specifying Destination on page 5-26](#).

4 Set the sending size, original image, etc., as desired.

For the features that can be set, refer to [Custom Box \(Store File, Printing, Send\) \(page 6-6\)](#).

5 Press the [**Start**] key.

Sending of the selected document begins.

Editing Documents

This function allows you to move or copy documents stored in custom boxes into other boxes or to join multiple documents together. You can also copy documents to USB memory connected to this machine.

Moving a Document/Copying a Document (Move/Copy)

The procedure for moving or copying documents is explained below.

1 Display the screen.

- 1 Press [Custom Box] on the Home screen.

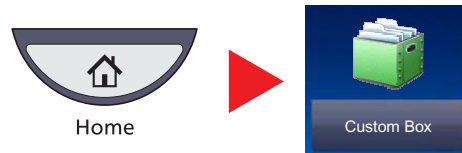

- 2 Select the box containing the document you want to move or copy.
- 3 Press [Open].



NOTE

If a custom box is protected by a password, enter the correct password.

2 Move or copy documents.

- 1 Select the document in the list that you want to move or copy by pressing the checkbox.

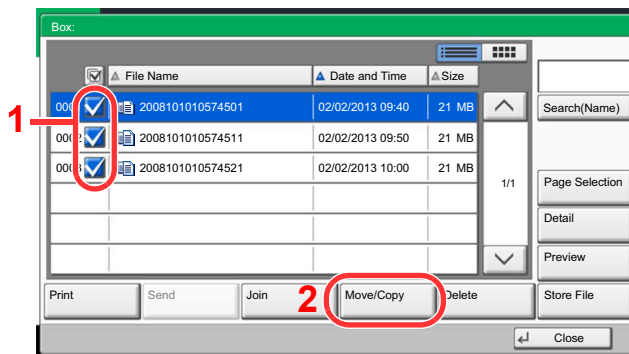

The document is marked with a checkmark.



NOTE

To deselect, press the checkbox again and remove the checkmark.

- 2 Press [Move/Copy].

3 Select the function you want to execute.

To move the document, press [Move to Custom Box].

To copy the document, press [Copy to Custom Box] or [Copy to Memory].

4 Press [Next].

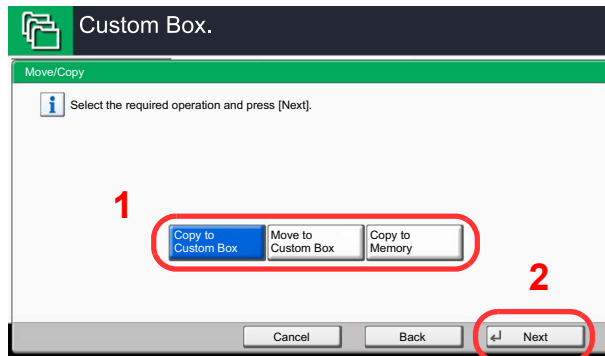

5 Select the destination of copy or move.

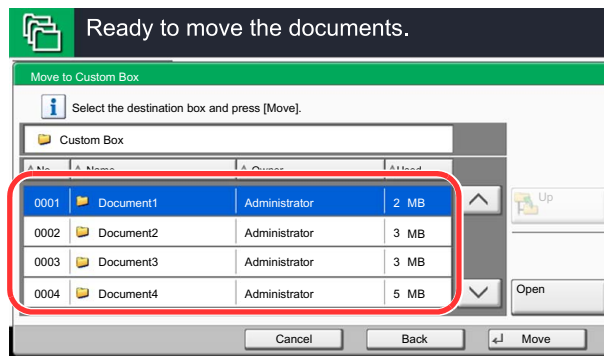

To copy or move the document to a custom box, select the destination box.

To copy the document to USB memory, select the destination folder and press [Next]. If necessary, set the saved file size and the file format, etc.

6 Press [Move] or [Copy] and then press [Yes] in the confirmation screen.

The selected document is moved or copied.



NOTE

If the box to which the document is to be moved or copied is protected by a password, enter the correct password.

Joining Documents (Join)

You can join documents within a custom box into one file.

NOTE

You can only join a document to other documents in the same custom box. If necessary, move the documents to be joined beforehand.

1 Display the screen.

- 1 Press [Custom Box] on the Home screen.

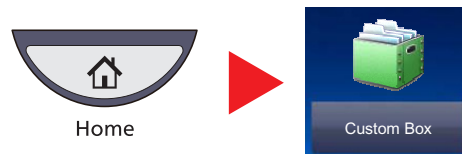

- 2 Select the box containing the documents you want to join and press [Open].

NOTE

If a custom box is protected by a password, enter the correct password.

2 Join the document.

- 1 Select the documents in the list that you wish to join by pressing the checkbox.

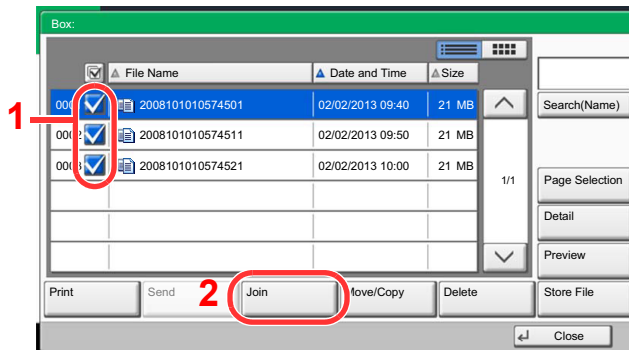

The document is marked with a checkmark.

You can join up to 10 documents.

NOTE

To deselect, press the checkbox again and remove the checkmark.

- 2 Press [Join].

- 3 Arrange the documents into the order in which they are to be joined.

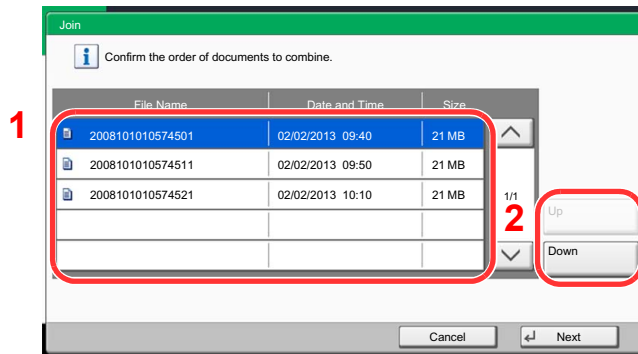

Highlight the document you want to rearrange and press [Up] or [Down] to move it to the correct place in the sequence.

- 4 Press [Next].
- 5 Press [File Name], enter the file name for the joined document and press [OK].

 **NOTE**

Enter up to 64 characters as the file name.

- 6 Press [Join] and then press [Yes] in the confirmation screen.
The documents are joined.

 **NOTE**

After joining, the original documents are left unchanged. Delete the documents if they are no longer needed.

Deleting Documents

The procedure for deleting documents in a custom box is explained below.

1 Display the screen.

- 1 Press [Custom Box] on the Home screen.

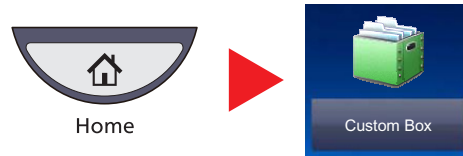

- 2 Select the box containing the document you want to delete and press [Open].



NOTE

If a custom box is protected by a password, enter the correct password.

2 Delete the document.

- 1 Select the document you wish to delete by checking the checkbox.

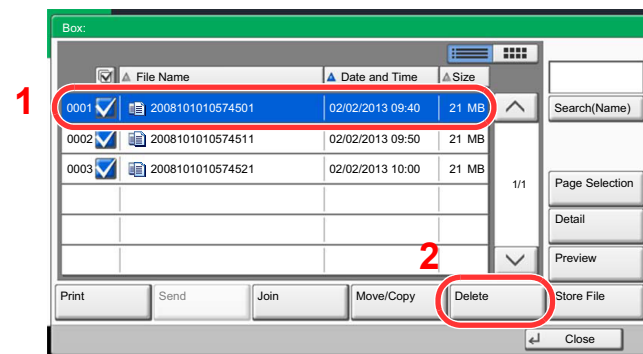

The document is marked with a checkmark.



NOTE

[Delete] is disabled until a document is selected.
To deselect, press the checkbox again and remove the checkmark.

- 2 Press [Delete].
The delete confirmation screen appears.
- 3 Press [Yes].
The document is deleted.

Job Box

This section explains the Repeat Copy Box and the Form for Form Overlay Box. For Private Print/Stored Job Box and Quick Copy/Proof and Hold Box, refer to [Private Print/Stored Job on page 4-14](#) and [Quick Copy/Proof and Hold on page 4-16](#).

Outputting Repeat Copy Jobs

Repeat Copy feature stores the copied original document data in the Job Box and allows you to print additional copies later. By default, up to 32 documents can be stored. When power is turned off, all stored jobs will be deleted. This section explains how to print documents saved by the Repeat Copy function.

 [Repeat Copy \(page 6-54\)](#)

1 Display the screen.

- 1 Press [Job Box] on the Home screen.

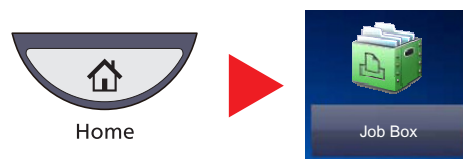

- 2 Select [Repeat Copy] box, and press [Open].

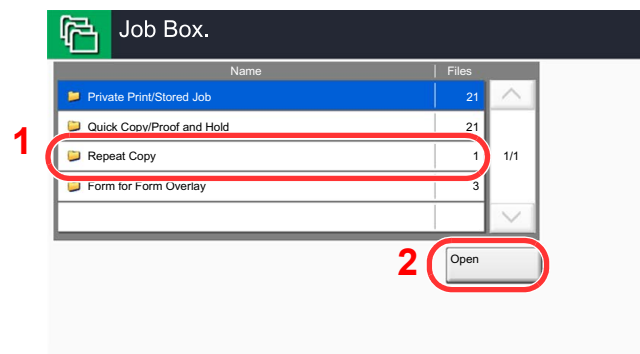

2 Print the document.

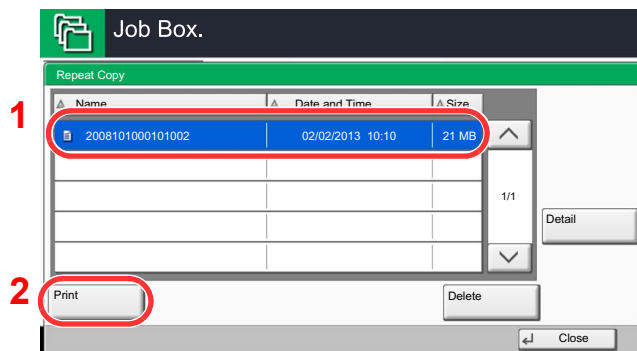

- 1 Select the document to print and press [Print].
If the document is protected by a password, enter the password using the numeric keys.
- 2 Specify the number of copies to print as desired.
- 3 Press [Start Print].
Printing begins.
The Repeat Copy box job will be deleted when the main power switch is turned off.

Form for Form Overlay

Image Overlay feature copies the original document overlaid with a form or image. This Job Box is used to store the forms or images for overlaying.

Storing a Form

You can store forms to be used for the form overlay in the job box. One page can be registered in one form.

1 Place the original in the document processor or on the platen.

2 Display the screen.

1 Press [Job Box] on the Home screen.

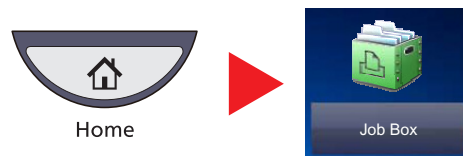

2 Select [Form for Form Overlay] and press [Open].

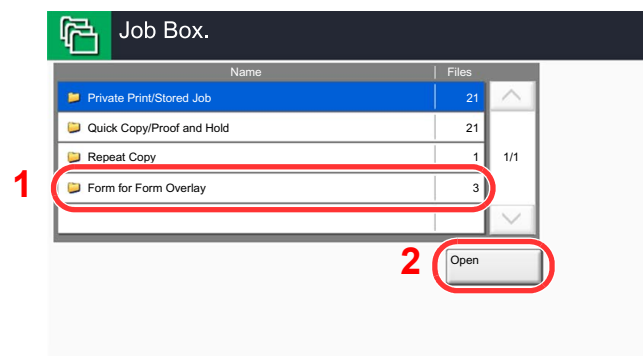

3 Store the forms.

1 Press [Store File].

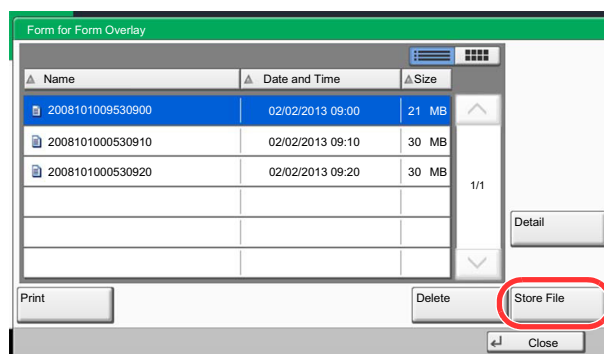

2 If necessary, select the image quality of original, scanning density, etc. before the original is scanned.

3 Press the [Start] key.

The original is scanned and stored in the [Form for Form Overlay] box.

Deleting a Form Stored

You can delete the form stored in the job box

1 Display the screen.

- 1 Press [Job Box] on the Home screen.

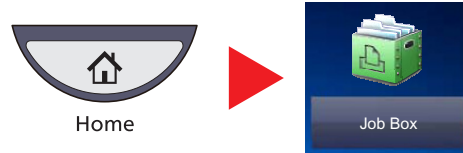

- 2 Select [Form for Form Overlay] and press [Open].

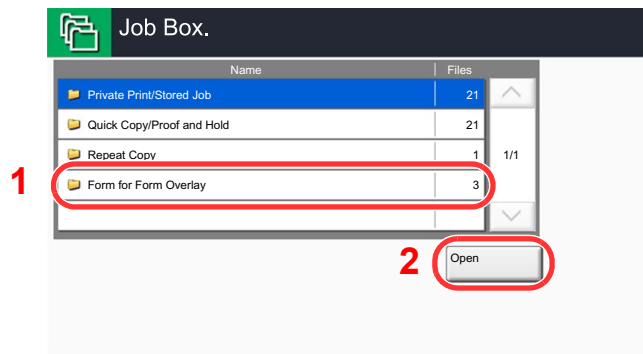

2 Delete the forms.

- 1 Select the form to delete and press [Delete].

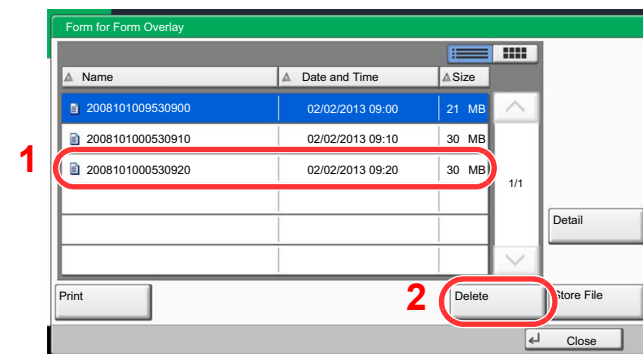

The delete confirmation screen appears.

- 2 Press [Yes].

The form is deleted.

Printing Documents Stored in Removable USB Memory

Plugging USB memory directly into the machine enables you to quickly and easily print the files stored in the USB memory without having to use a computer.

The following file types can be printed:

- PDF file (Version 1.7 or older)
- TIFF file (TIFF V6/TTN2 format)
- JPEG file
- XPS file
- Encrypted PDF file
- PDF files you wish to print should have an extension (.pdf).
- Files to be printed should be saved no further down than the top 3 folder levels, including the root folder.
- Use USB memory properly formatted by this machine.
- Plug the USB memory directly into the USB Port (A1).

1 Plug the USB memory.

- 1 Plug the USB memory into the USB Port (A1).

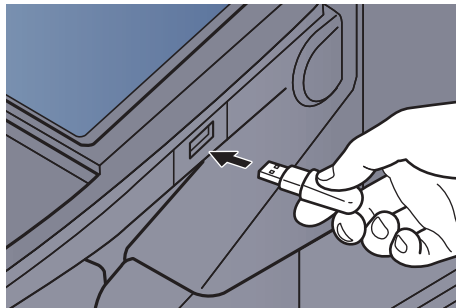

- 2 When the machine reads the USB memory, "Removable Memory is recognized. Displaying files. Are you sure?" may appear. Press [Yes].

Displays the removable memory screen.

✔ IMPORTANT

Use USB memory properly formatted by this machine. If a USB memory formatted by any other device is used, "The removable memory is not formatted." may appear. To format the USB memory, refer to [Device/Communication on page 7-17](#).

💡 NOTE

If the message does not appear, press [Removable Memory].

2 Print the document.

- 1 Select the folder containing the file to be printed and press [Open].

The machine will display documents in the top 3 folder levels, including the root folder.

💡 NOTE

1,000 documents can be displayed.

To return to a higher level folder, press [Up].

- 2** Select the file to be printed and press [Print].

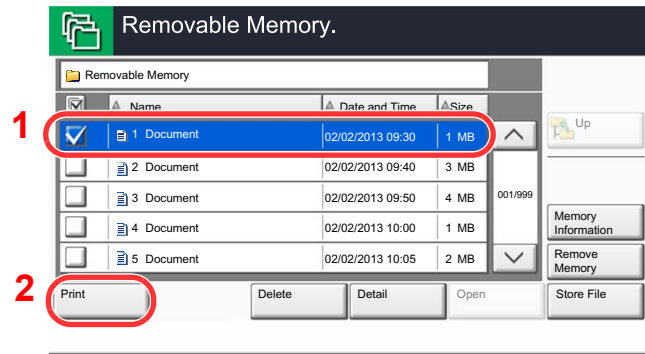

- 3** Change the number of copies, duplex printing, etc. as desired.

For the features that can be selected, refer to [Removable Memory \(Store File, Printing Documents\)](#) (page 6-9).

After a document saved in the machine is selected, [Use File Settings] may appear in the setting screen for the feature to be used.

- To use the settings saved with the document, press [Use File Settings].
- If you need to change the print settings, select the desired feature.

- 4** Press the [Start] key.

Printing of the selected file begins.

Saving Documents to USB Memory (Scan to USB)

This function allows you to store scanned image files in USB memory connected to the machine. You can store files in PDF, TIFF, JPEG, XPS or high-compression PDF format.

NOTE

The maximum number of the storable files is 1,000.

1 Place the originals.

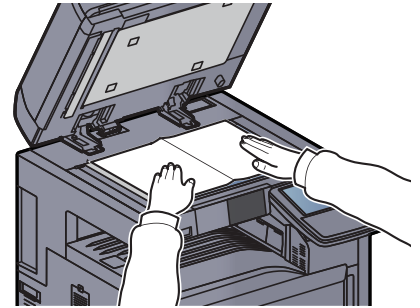
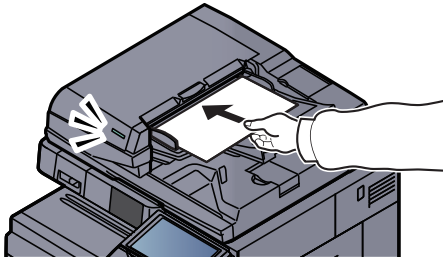

Refer to [Loading Originals on page 5-2](#).

2 Plug the USB memory.

Plug the USB memory into the USB Port (A1).

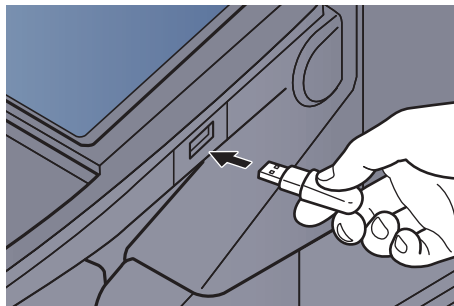

When the machine reads the USB memory, "Removable Memory is recognized. Displaying files. Are you sure?" may appear. Press [Yes] to display the removable memory screen.

IMPORTANT

Use USB memory properly formatted by this machine. If a USB memory formatted by any other device is used, "The removable memory is not formatted." may appear. To format the USB memory, refer to [Device/Communication on page 7-17](#).

When [Format] is pressed, all data in the external media is erased.

NOTE

If the message does not appear, press [Removable Memory].

3 Store the document.

- 1 Select the folder where the file will be stored and press [Open].
The machine will display the top 3 folder levels, including the root folder.
- 2 Press [Store File].

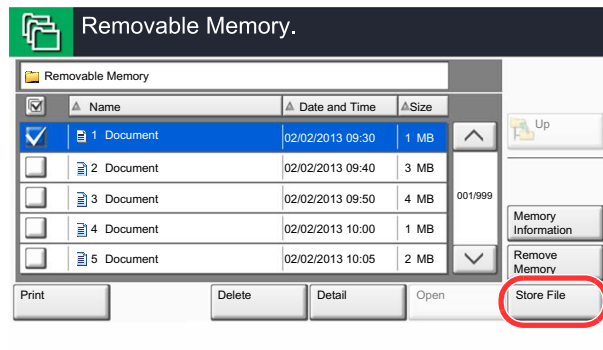

- 3 Set the type of original, file format, etc., as desired.
For the features that can be set, refer to [Removable Memory \(Store File, Printing Documents\) \(page 6-9\)](#).
- 4 Press the [Start] key.
The original is scanned and the data is stored in the USB memory.

Check the USB memory information

You can check the USB memory information.
In the removable memory screen, press [Memory Information].

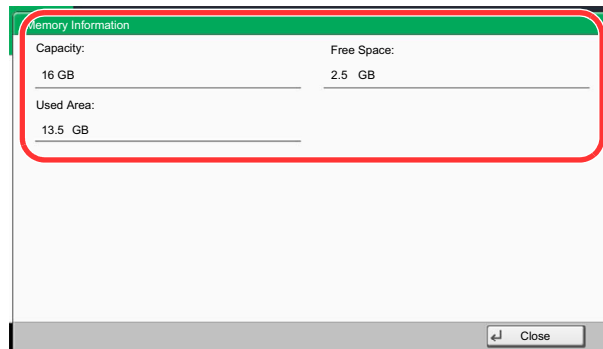

Once you confirm the information, press [Close].

Removing USB Memory

Follow the steps below to remove the USB memory.

 **IMPORTANT**

Be sure to follow the proper procedure to avoid damaging the data or USB memory.

1 Press [Removable Memory].

2 Press [Remove Memory].

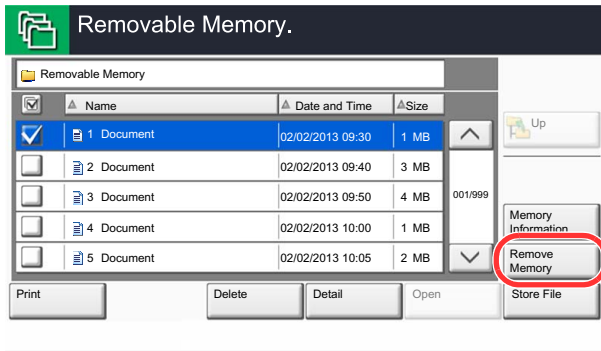

Press [OK], and remove the USB memory after "Removable Memory can be safely removed." is displayed.



NOTE

USB memory can also be removed after checking the status of the device. Refer to [Device/Communication on page 7-17](#).

Manual Staple

You can staple copied paper manually without any print operation. It is useful when you have forgotten to set the staple sort mode before starting copying, or when you want to staple originals.

NOTE

If there are no staples when manual stapling is performed, the stapling position lamps and stapling position key LEDs all blink. Add staples. For details, refer to [Replacing Staples on page 10-12](#).

Manual stapling cannot be executed when the machine is in operation.

Maximum number of sheets available for manual stapling

Paper size	Paper weight	
	- 90 g/m ² (- 24.0 lb. Bond)	91 - 105 g/m ² (24.3 - 28.0 lb. Bond)
A4, A4-R, B5, Letter, 16K	65 sheets	50 sheets
A3, B4, Folio	30 sheets	30 sheets

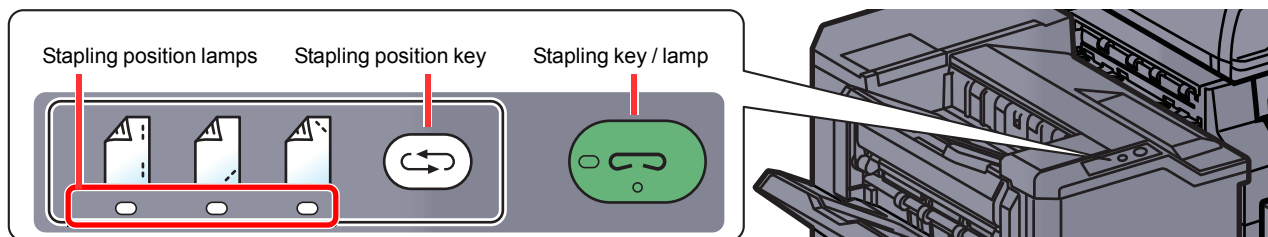

Use the keys on the control section of the 4,000-Sheet Finisher (optional) for manual stapling.



1 Press the stapling position key on the stapling control section.

The shutter of the paper exit area is opened and this equipment enters into the manual staple mode.

2 Set the staple position.

Press the stapling position key to select the stapling position (Back  / Front  / 2 Points .

Operation is not possible while the stapling position lamps are blinking. Operate after the lamps light solidly.

3 Load the paper.

Straighten the edges of the paper well and place the paper front side down in the shutter opening of the output unit.

If the near side of the paper (A) will be stapled, place the paper against the front guide (A).

If the far side of the paper (B) will be stapled, place the paper against the back guide (B).

If the edge of the paper (C) will be stapled at two points, place the paper with the center aligned to the center point between the two side guides (A and B).

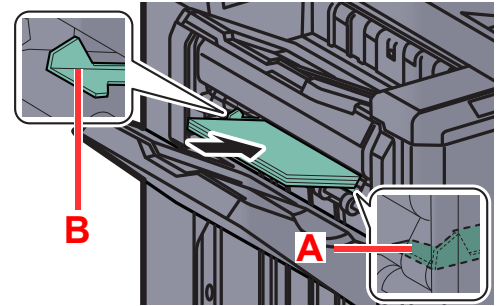

CAUTION

Do not insert your hand inside the open shutter.

NOTE

- Press the stapling position key before you place the paper. Once the paper is placed, the stapling position key cannot be used.
- The stapling lamp lights when the paper is properly placed. If it does not light, replace the paper.

4 Staple the paper.

Let go of the paper, and then press the stapling key.

Stapling starts. Stapling finishes and the output is delivered to tray A.

CAUTION

Be sure that your hands are away from the paper while stapling is in progress.

Finishing the manual staple mode

Press the stapling position key several times until the stapling position lamps turn off. The shutter of the paper exit area closes. It means that manual stapling is finished.

If no operation is performed for approx. 10 seconds, the manual staple mode will be automatically finished.

NOTE

The time after which manual staple mode is automatically exited can be changed. For details, refer to [Manual Staple on page 8-24](#).

6 Using Various Functions

This chapter explains the following topics:

Functions Available on the Machine	6-2	2-sided/Book Original, Book Original	6-56
Copy	6-2	Sending Size	6-57
Send	6-4	File Format	6-58
Custom Box (Store File, Printing, Send)	6-6	File Separation	6-61
Removable Memory (Store File, Printing Documents)	6-9	Scan Resolution, Resolution	6-61
Functions	6-11	E-mail Subject/Body	6-61
Original Size	6-11	Send and Print	6-62
Paper Selection	6-12	Send and Store	6-62
Mixed Size Originals	6-13	FTP Encrypted TX	6-63
Original Orientation	6-15	File Size Confirmation	6-63
Fold	6-16	Delete after Printed	6-63
Collate/Offset	6-17	Delete after Transmitted	6-63
Staple/Punch	6-18	Storing Size	6-64
Paper Output	6-21	Encrypted PDF Password	6-64
Density	6-21	JPEG/TIFF Print	6-65
Original Image	6-22	XPS Fit to Page	6-65
EcoPrint	6-23	Functions Available in the Home Screen	6-66
Color Selection	6-23	Send to Me (E-mail)	6-66
Sharpness	6-24	Send to Me from Box (E-mail)	6-66
Background Density Adj.	6-24		
Prevent Bleed-thru	6-25		
Zoom	6-26		
Combine	6-30		
Margin/Centering, Margin, Centering	6-32		
Border Erase	6-33		
Booklet	6-35		
Duplex	6-38		
Cover	6-41		
Form Overlay	6-42		
Page #	6-43		
Memo Page	6-45		
Image Repeat	6-46		
Text Stamp	6-47		
Bates Stamp	6-49		
Continuous Scan	6-51		
Auto Image Rotation	6-52		
Negative Image	6-52		
Mirror Image	6-52		
Job Finish Notice	6-53		
File Name Entry	6-53		
Priority Override	6-54		
Repeat Copy	6-54		
DP Read Action	6-55		
Skip Blank Page	6-55		

Functions Available on the Machine

Copy

To configure the settings for functions, select the tab and press the function key.

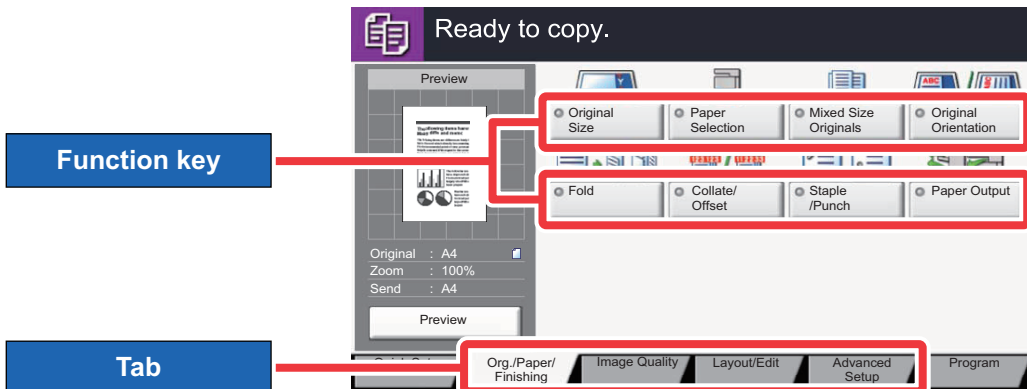

For details on each function, see the table below.

Tab	Function key	Description	Reference page
<p>Org./Paper/Finishing</p> <p>Configure the settings for originals, paper, and finishing such as collate and staple.</p>	Original Size	Specify the original size to be scanned.	page 6-11
	Paper Selection	Select the cassette or multi-purpose tray that contains the required paper size.	page 6-12
	Mixed Size Originals	Scans all sheets in the document processor, even if they are of different sizes.	page 6-13
	Original Orientation	Select the orientation of the original document top edge to scan correct direction.	page 6-15
	Fold	Folds the finished documents.	page 6-16
	Collate/Offset	Offsets the output by page or set.	page 6-17
	Staple/Punch	Staples or punches printed documents.	page 6-18
	Paper Output	Specify the output tray.	page 6-21
<p>Image Quality</p> <p>Configure the settings for density, quality of copies, and color balance.</p>	Density	Adjust density using 7 or 13 levels.	page 6-21
	Original Image	Select original image type for best results.	page 6-22
	EcoPrint	EcoPrint saves toner when printing.	page 6-23
	Sharpness	Adjusts the sharpness of image outlines.	page 6-24
	Background Density Adj.	Removes dark background from originals, such as newspapers.	page 6-24
	Prevent Bleed-thru	Hides background colors and image bleed-through when scanning thin original.	page 6-25

Tab
<div style="border: 1px solid black; padding: 5px; width: fit-content; margin: 0 auto;">Layout/Edit</div> <p>Configure the settings for duplex printing and stamp.</p>

Function key	Description	Reference page
Zoom	Adjusts the zoom to reduce or enlarge the image.	page 6-26
Combine	Combines 2 or 4 original sheets into 1 printed page.	page 6-30
Margin/Centering	<p>Margin: Add margins (white space). In addition, you can set the margin width and the back page margin.</p> <p>Centering: Centers the original image on the paper when copying onto paper different from the original size.</p>	page 6-32
Border Erase	Erases the black border that forms around the image.	page 6-33
Booklet	Prints documents to 2-sided open book sheets.	page 6-35
Duplex	Produces two-sided copies. You can also create single-sided copies from two-sided originals or originals with facing pages such as books.	page 6-38
Cover	Adds a cover to the finished documents.	page 6-41
Form	Prints the original document overlaid with a form or image.	page 6-42
Page #	Adds page numbers to the finished documents.	page 6-43
Memo Page	Delivers copies with a space for adding notes.	page 6-45
Image Repeat	Tiles the original image on one sheet of paper.	page 6-46
Text Stamp	You can add a text stamp on the documents.	page 6-47
Bates Stamp	You can add a bates stamp on the documents.	page 6-49

<div style="border: 1px solid black; padding: 5px; width: fit-content; margin: 0 auto;">Advanced Setup</div> <p>Configure the settings for continuous scanning, mirror image copies, and Skip Blank Page function.</p>
--

Continuous Scan	Scans a large number of originals in separate batches and then produce as one job.	page 6-51
Auto Image Rotation	Automatically rotates the image 90 degrees when the sizes of the original and the loaded paper matches but the orientations are different.	page 6-52
Negative Image	Inverts black and white portions of the image for printing.	page 6-52
Mirror Image	Copies the mirrored image of the original.	page 6-52
Job Finish Notice	Sends E-mail notice when a job is complete.	page 6-53
File Name Entry	Adds a file name.	page 6-53
Priority Override	Suspends the current job and gives a new job top priority.	page 6-54
Repeat Copy	Enables additional copies in the desired quantity as necessary after a copy job is completed.	page 6-54
DP Read Action	When the document processor is used, select the scanning operation for the document processor.	page 6-55
Skip Blank Page	When there are blank pages in a scanned document, this function skips the blank pages and prints only pages that are not blank.	page 6-55

Send

To configure the settings for functions, select the tab and press the function key.

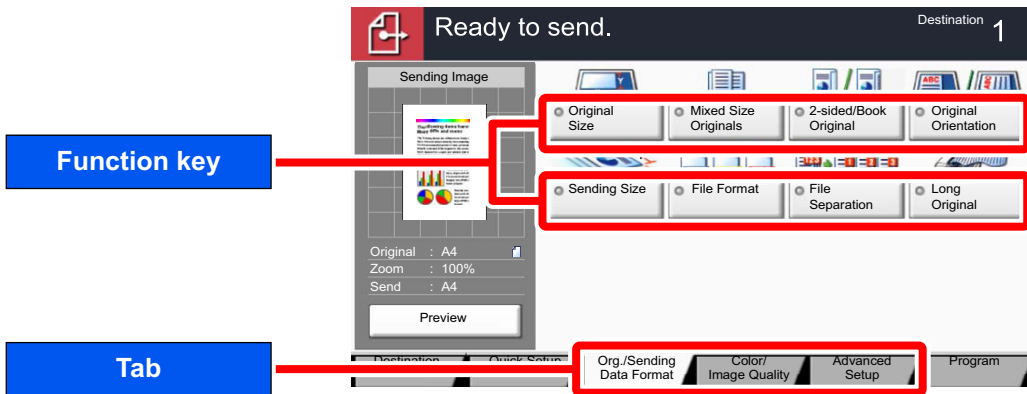

For details on each function, see the table below.

Tab	Function key	Description	Reference page
<p>Org./Sending Data Format</p> <p>Configure the settings for original type and file format.</p>	Original Size	Specify the original size to be scanned.	page 6-11
	Mixed Size Originals	Scans all sheets in the document processor, even if they are of different sizes.	page 6-13
	2-sided/Book Original	Select the type and orientation of the binding based on the original.	page 6-56
	Original Orientation	Select the orientation of the original document top edge to scan correct direction.	page 6-15
	Sending Size	Select size of image to be sent.	page 6-57
	File Format	Specify the image file format. Image quality level can also be adjusted.	page 6-58
	File Separation	Creates several files by dividing scanned original data page by page before sending the files.	page 6-61
	Long Original	Reads long-sized original documents using a document processor.	Refer to the FAX Operation Guide .
<p>Color/Image Quality</p> <p>Configure the settings for density, quality of copies, and color balance.</p>	Density	Adjust density using 7 or 13 levels.	page 6-21
	Original Image	Select original image type for best results.	page 6-22
	Scan Resolution	Select fineness of scanning resolution.	page 6-61
	FAX TX Resolution	Select fineness of images when sending FAX.	Refer to the FAX Operation Guide .
	Color Selection	Select the color mode setting.	page 6-23
	Sharpness	Adjusts the sharpness of image outlines.	page 6-24
	Background Density Adj.	Removes dark background from originals, such as newspapers.	page 6-24
	Prevent Bleed-thru	Hides background colors and image bleed-through when scanning thin original.	page 6-25

Tab	Function key	Description	Reference page
<div data-bbox="105 801 309 878" style="border: 1px solid black; padding: 5px; width: fit-content; margin-bottom: 10px;">Advanced Setup</div> <p data-bbox="105 887 338 1016">Configure the settings for transmission copy, encrypted transmission, and file size confirmation.</p>	Zoom	Adjusts the zoom to reduce or enlarge the image.	page 6-26
	Centering	Centering: Centers the original image on the paper when copying onto paper different from the original size.	page 6-32
	Border Erase	Erases the black border that forms around the image.	page 6-33
	FAX Delayed Transmission	Set a send time.	Refer to the FAX Operation Guide .
	Continuous Scan	Scans a large number of originals in separate batches and then produce as one job.	page 6-51
	Job Finish Notice	Sends E-mail notice when a job is complete.	page 6-53
	File Name Entry	Adds a file name.	page 6-53
	E-mail Subject/Body	Adds subject and body when sending a document.	page 6-61
	i-FAX Subject/Body	Adds subject and body when sending a document by i-FAX.	Refer to the FAX Operation Guide .
	FAX Direct Transmission	Sends FAX directly without reading original data into memory.	Refer to the FAX Operation Guide .
	FAX Polling RX	Automatically makes a machine with a stored document send the document to your machine.	Refer to the FAX Operation Guide .
	Send and Print	Allows you to print a copy of the document being sent.	page 6-62
	Send and Store	Allows you to store a copy of the document being sent in a Custom Box.	page 6-62
	FTP Encrypted TX	Encrypts images when sending via FTP.	page 6-63
	Text Stamp	You can add a text stamp on the documents.	page 6-47
	Bates Stamp	You can add a bates stamp on the documents.	page 6-49
	File Size Confirmation	Checks the file size before sending/storing the original.	page 6-63
FAX TX Report	Prints a report when transmission of a document is successful, or when an error occurs and transmission fails.	Refer to the FAX Operation Guide .	

Custom Box (Store File, Printing, Send)

To configure the settings for functions, select the tab and press the function key.

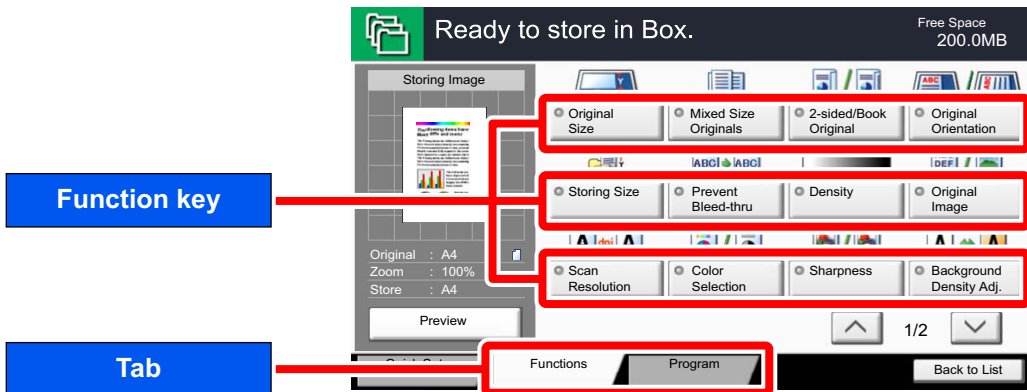

For details on each function, see the table below.

Store File

Tab	Function key	Description	Reference page
<div style="border: 1px solid black; padding: 5px; width: fit-content; margin-bottom: 10px;">Functions</div> Configure the settings when storing the document in the Custom Box.	Original Size	Specify the original size to be scanned.	page 6-11
	Mixed Size Originals	Scans all sheets in the document processor, even if they are of different sizes.	page 6-13
	2-sided/Book Original	Select the type and orientation of the binding based on the original.	page 6-56
	Original Orientation	Select the orientation of the original document top edge to scan correct direction.	page 6-15
	Storing Size	Select size of image to be stored.	page 6-64
	Prevent Bleed-thru	Hides background colors and image bleed-through when scanning thin original.	page 6-25
	Density	Adjust density using 7 or 13 levels.	page 6-21
	Original Image	Select original image type for best results.	page 6-22
	Scan Resolution	Select fineness of scanning resolution.	page 6-61
	Color Selection	Select the color mode setting.	page 6-23
	Sharpness	Adjusts the sharpness of image outlines.	page 6-24
	Background Density Adj.	Removes dark background from originals, such as newspapers.	page 6-24
	Zoom	Adjusts the zoom to reduce or enlarge the image.	page 6-26
	Centering	Centering: Centers the original image on the paper when copying onto paper different from the original size.	page 6-32
	Border Erase	Erases the black border that forms around the image.	page 6-33
	Continuous Scan	Scans a large number of originals in separate batches and then produce as one job.	page 6-51
Job Finish Notice	Sends E-mail notice when a job is complete.	page 6-53	
File Name Entry	Adds a file name.	page 6-53	

Print

Tab	Function key	Description	Reference page
<div data-bbox="105 815 308 887" style="border: 1px solid black; padding: 2px; margin-bottom: 5px;">Functions</div> <p data-bbox="105 898 339 1039">Configure the settings for paper selection and duplex printing when printing from the Custom Box.</p>	Paper Selection	Select the cassette or multi-purpose tray that contains the required paper size.	page 6-12
	Collate/Offset	Offsets the output by page or set.	page 6-17
	Staple/Punch	Staples or punches printed documents.	page 6-18
	Paper Output	Specify the output tray.	page 6-21
	Combine	Combines 2 or 4 original sheets into 1 printed page.	page 6-30
	Margin/Centering	Margin: Add margins (white space). In addition, you can set the margin width and the back page margin. Centering: Centers the original image on the paper when copying onto paper different from the original size.	page 6-32
	Booklet	Prints documents to 2-sided open book sheets.	page 6-35
	Duplex	Produces two-sided copies. You can also create single-sided copies from two-sided originals or originals with facing pages such as books.	page 6-40
	Cover	Adds a cover to the finished documents.	page 6-41
	Form Overlay	Copies the original document overlaid with a form or image.	page 6-42
	Page #	Adds page numbers to the finished documents.	page 6-43
	Job Finish Notice	Sends E-mail notice when a job is complete.	page 6-53
	File Name Entry	Adds a file name.	page 6-53
	Delete after Printed	Automatically deletes a document from the box once printing is complete.	page 6-63
	Priority Override	Suspends the current job and gives a new job top priority.	page 6-54
	EcoPrint	EcoPrint saves toner when printing.	page 6-23
	Zoom	Adjusts the zoom to reduce or enlarge the image.	page 6-26
	Fold	Folds the finished documents.	page 6-16
Text Stamp	You can add a text stamp on the documents.	page 6-47	
Bates Stamp	You can add a bates stamp on the documents.	page 6-49	
<div data-bbox="105 1641 308 1713" style="border: 1px solid black; padding: 2px; margin-bottom: 5px;">Image Quality</div> <p data-bbox="105 1724 339 1843">Configure the settings for density, quality of copies, and color balance.</p>	Density	Adjust density using 7 or 13 levels.	page 6-21
Original Image	Select original image type for best results.	page 6-22	
Sharpness	Adjusts the sharpness of image outlines.	page 6-24	
Background Density Adj.	Removes dark background from originals, such as newspapers.	page 6-24	
Prevent Bleed-thru	Hides background colors and image bleed-through when scanning thin original.	page 6-25	

Send

Tab	Function key	Description	Reference page
<div data-bbox="105 808 309 882" style="border: 1px solid black; padding: 2px; margin-bottom: 10px;">Functions</div> <p data-bbox="105 891 341 1032">Configure the settings for file format and FAX transmission when sending from the Custom Box.</p>	Sending Size	Select size of image to be sent.	page 6-57
	File Format	Specify the image file format. Image quality level can also be adjusted.	page 6-58
	FAX TX Resolution	Select fineness of images when sending FAX.	Refer to the FAX Operation Guide .
	Centering	Centers the original image on the paper when copying onto paper different from the original size.	page 6-32
	FAX Delayed Transmission	Set a send time.	Refer to the FAX Operation Guide .
	Job Finish Notice	Sends E-mail notice when a job is complete.	page 6-53
	File Name Entry	Adds a file name.	page 6-53
	E-mail Subject/Body	Adds subject and body when sending a document.	page 6-61
	i-FAX Subject/Body	Adds subject and body when sending a document by i-FAX.	Refer to the FAX Operation Guide .
	FTP Encrypted TX	Encrypts images when sending via FTP.	page 6-63
	Delete after Transmitted	Automatically deletes a document from the box once transmission is complete.	page 6-63
	Zoom	Adjusts the zoom to reduce or enlarge the image.	page 6-26
	File Separation	Creates several files by dividing scanned original data page by page before sending the files.	page 6-61
	Text Stamp	You can add a text stamp on the documents.	page 6-47
	Bates Stamp	You can add a bates stamp on the documents.	page 6-49
File Size Confirmation	Checks the file size before sending/storing the original.	page 6-63	
FAX TX Report	Prints a report when transmission of a document is successful, or when an error occurs and transmission fails.	Refer to the FAX Operation Guide .	
<div data-bbox="105 1682 309 1756" style="border: 1px solid black; padding: 2px; margin-bottom: 10px;">Color/ Image Quality</div> <p data-bbox="105 1765 341 1883">Configure the settings for density, quality of copies, and color balance.</p>	Density	Adjust density using 7 or 13 levels.	page 6-21
	Original Image	Select original image type for best results.	page 6-22
	Resolution	Select fineness of scanning resolution.	page 6-61
	Color Selection	Select the color mode setting.	page 6-23
	Sharpness	Adjusts the sharpness of image outlines.	page 6-24
	Background Density Adj.	Removes dark background from originals, such as newspapers.	page 6-24
	Prevent Bleed-thru	Hides background colors and image bleed-through when scanning thin original.	page 6-25

Removable Memory (Store File, Printing Documents)

To configure the settings for functions, select the tab and press the function key.

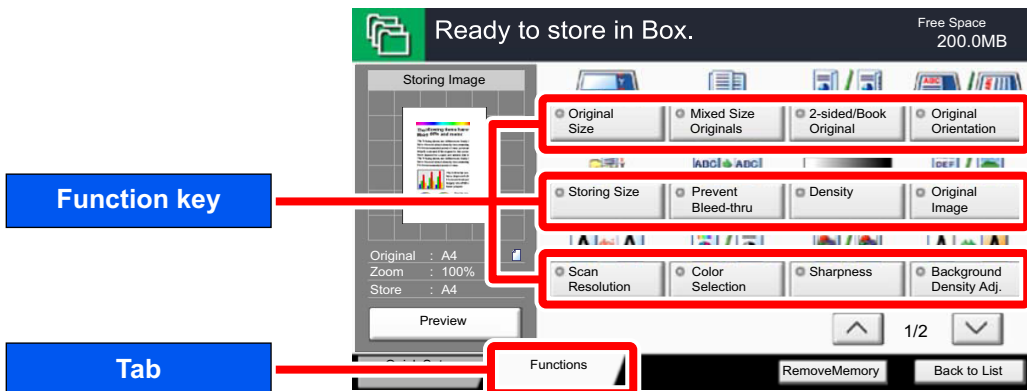

For details on each function, see the table below.

Store File

Tab	Function key	Description	Reference page
<div style="border: 1px solid black; padding: 5px; width: fit-content; margin-bottom: 10px;">Functions</div> <p>Configure the settings for color selection and document name when storing the document in the removable memory.</p>	Original Size	Specify the original size to be scanned.	page 6-11
	Mixed Size Originals	Scans all sheets in the document processor, even if they are of different sizes.	page 6-13
	2-sided/Book Original	Select the type and orientation of the binding based on the original.	page 6-56
	Original Orientation	Select the orientation of the original document top edge to scan correct direction.	page 6-15
	Storing Size	Select size of image to be stored.	page 6-64
	Prevent Bleed-thru	Hides background colors and image bleed-through when scanning thin original.	page 6-25
	Density	Adjust density using 7 or 13 levels.	page 6-21
	Original Image	Select original image type for best results.	page 6-22
	Scan Resolution	Select fineness of scanning resolution.	page 6-61
	Color Selection	Select the color mode setting.	page 6-23
	Sharpness	Adjusts the sharpness of image outlines.	page 6-24
	Background Density Adj.	Removes dark background from originals, such as newspapers.	page 6-24
	Zoom	Adjusts the zoom to reduce or enlarge the image.	page 6-26
	Centering	Centers the original image on the paper when copying onto paper different from the original size.	page 6-32
	Border Erase	Erases the black border that forms around the image.	page 6-33
	Continuous Scan	Scans a large number of originals in separate batches and then produce as one job.	page 6-51
	Job Finish Notice	Sends E-mail notice when a job is complete.	page 6-53
	File Name Entry	Adds a file name.	page 6-53
	File Format	Specify the image file format. Image quality level can also be adjusted.	page 6-58
	File Separation	Creates several files by dividing scanned original data page by page before sending the files.	page 6-61
Text Stamp	You can add a text stamp on the documents.	page 6-47	
Bates Stamp	You can add a bates stamp on the documents.	page 6-49	

Printing Documents

Tab	Function key	Description	Reference page
<div data-bbox="105 645 308 719" style="border: 1px solid black; padding: 2px; width: fit-content; margin-bottom: 10px;">Functions</div> <p data-bbox="105 728 339 875">Configure the settings for paper selection and duplex printing when printing from the removable memory.</p>	Paper Selection	Select the cassette or multi-purpose tray that contains the required paper size.	page 6-12
	Collate/Offset	Offsets the output by page or set.	page 6-17
	Staple/Punch	Staples or punches printed documents.	page 6-18
	Paper Output	Specify the output tray.	page 6-21
	Margin	Add margins (white space). In addition, you can set the margin width and the back page margin.	page 6-32
	2-sided	Print a document to 1-sided or 2-sided sheets.	page 6-40
	Job Finish Notice	Sends E-mail notice when a job is complete.	page 6-53
	Priority Override	Suspends the current job and gives a new job top priority.	page 6-54
	EcoPrint	EcoPrint saves toner when printing.	page 6-23
	Fold	Folds the finished documents.	page 6-16
	Text Stamp	You can add a text stamp on the documents.	page 6-47
	Bates Stamp	You can add a bates stamp on the documents.	page 6-49
	Encrypted PDF Password	Enter the preassigned password to print the PDF data.	page 6-64
	JPEG/TIFF Print	Select the image size when printing JPEG or TIFF files.	page 6-65
XPS Fit to Page	Reduces or enlarges the image size to fit to the selected paper size when printing XPS file.	page 6-65	

Functions

Original Size

Org./Paper/
FinishingOrg./Sending
Data Format

Functions



Functions

Specify the original size to be scanned.

Press [Standard Sizes 1], [Standard Sizes 2], [Others] or [Size Entry] to select the original size.

Item	Value	Description
Standard Sizes 1	Metric models: Auto, A3, A4, A4-R, A5, A5-R, A6-R, B4-R, B5, B5-R, B6, B6-R, Folio, 216x340 mm Inch models: Auto, Ledger, Letter, Letter-R, Legal, Statement, Statement-R, 11 x 15", Oficio II	Have the size of original detected automatically, or select from the standard sizes.
Standard Sizes 2	Metric models: Ledger, Letter, Letter-R, Legal-R, Statement, Statement-R, 11 x 15", Oficio II, 8K, 16K, 16K-R Inch models: A3, A4, A4-R, A5, A5-R, A6-R, B4, B5, B5-R, B6, B6-R, Folio, 8K, 16K, 16K-R, 216 x 340 mm	Select from standard sizes except Standard Sizes 1.
Others	Hagaki, Oufuku hagaki, Custom 1 to 4* ¹	Select from envelope, postcard or the custom sized originals* ¹ .
Size Entry	Metric X: 50 to 432 mm (in 1 mm increments) Y: 50 to 297 mm (in 1 mm increments) Inch X: 2.00 to 17.00" (in 1" increments) Y: 2.00 to 11.69" (in 1" increments)	Enter the size not included in the standard sizes 1 and 2.* ² When you have selected [Size Entry], press [+] or [-] to set the sizes of "X" (horizontal) and "Y" (vertical). Press [# Keys] to use the numeric keys for entry.

*1 For instructions on how to specify the custom original sizes (Custom 1 to 4), refer to [Custom Original Size on page 8-10](#). If "Custom Original Size" is set to [Off], this does not appear.

*2 The input units can be changed in System Menu. For details, refer to [Measurement on page 8-14](#).



NOTE

Be sure to always specify the original size when using custom size originals.

Paper Selection

Org./Paper/
Finishing

Functions



Functions

Select the cassette or multi-purpose tray that contains the required paper size.

Select from [1] (Cassette 1) to [5] (Cassette 5) to use the paper contained in that cassette.

If [Auto] is selected, the paper matching the size of the original is selected automatically.



NOTE

- Specify in advance the size and type of the paper loaded in the cassette (refer to [Cassette/MP Tray Settings on page 8-7](#)).
- Cassette 3 to Cassette 5 are displayed when the optional paper feeder is installed.

To select [MP tray], press [Paper Settings] and specify the paper size and the media type. The available paper sizes and media types are shown in the table below.

Item		Value	Description
Paper Settings	Standard Sizes 1	Metric models: A3, A4, A4-R, A5-R, A6-R, B4, B5, B5-R, B6-R, Folio, 216 x 340 mm Inch models: Ledger, Letter, Letter-R, Legal, Statement, Executive, Oficio II	Select from the standard size.
	Standard Sizes 2	Metric models: Ledger, Letter, Letter-R, Legal-R, Statement, Executive, Oficio II, 8K, 16K, 16K-R Inch models: A3, A4, A4-R, A5-R, A6-R, B4, B5, B5-R, B6-R, Folio, 8K, 16K, 16K-R, 216 x 340 mm	Select from standard sizes except Standard Sizes 1.
	Others	ISO B5, Envelope #10 (Commercial #10), Envelope #9 (Commercial #9), Envelope #6 (Commercial #6 3/4), Envelope Monarch, Envelope DL, Envelope C5, Envelope C4, Hagaki, Oufuku hagaki, Youkei 4, Youkei 2 and Custom 1 to 4 ^{*1}	Select from special standard sizes and custom sizes.
	Size Entry	Metric X: 148 to 457 mm (in 1 mm increments) Y: 98 to 304 mm (in 1 mm increments) Inch X: 5.83 to 18.00" (in 0.01" increments) Y: 3.86 to 12.00" (in 0.01" increments)	Enter the size not included in the standard size. ^{*2} When you have selected [Size Entry], press [+] or [-] to set the sizes of "X" (horizontal) and "Y" (vertical). Press [# Keys] to use the numeric keys for entry.
Media type		Plain (105 g/m ² or less), Transparency, Rough, Vellum (60 to 105 g/m ²), Labels, Recycled, Preprinted ^{*3} , Bond, Cardstock, Color, Prepunched ^{*3} , Letterhead ^{*3} , Thick (106 g/m ² and more), Envelope, Coated, High Quality, Index Tab Dividers, Custom 1-8 ^{*3}	

*1 For instructions on how to specify the custom paper sizes (Custom 1 to 4), refer to [Custom Paper Size on page 8-10](#).

*2 The input units can be changed in System Menu. For details, refer to [Measurement on page 8-14](#).

*3 For instructions on how to specify the custom paper types 1 to 8, refer to [Media Type Setting on page 8-13](#). To print on preprinted or prepunched paper or on letterhead, refer to [Special Paper Action on page 8-12](#).



IMPORTANT

When paper size and the media type for MP tray is specified, [Paper Settings] is selected. Note that if [Multipurpose tray] is pressed at this point, the settings will be canceled.



NOTE

- You can conveniently select in advance the size and type of paper that will be used often and set them as default (refer to [MP Tray Setting on page 8-8](#)).
- If the specified size of paper is not loaded in the paper source cassette or multi purpose tray, a confirmation screen appears. When [Auto] is selected and the same size of paper as the detected original size is not loaded, a paper confirmation screen appears. Load the required paper in the multi purpose tray and press [Continue] to start copying.

Mixed Size Originals

Org./Paper/
FinishingOrg./Sending
Data Format

Functions



Functions

Scans all sheets in the document processor, even if they are of different sizes.

Copying

Metric Models

Item		Value	Description
Off			
Mixed Size Copies	Original Width	Same Width, Different Width	Select options for the width of set original.
Same Size Copies	Original Width	Same Width, Different Width	Select options for the width of set original.
	Top Page Direction	Long Edge Left, Short Edge Left	Select the original orientation of the first page.

Inch Models

Item		Value	Description
Off			
Mixed Size Copies		—	Originals are detected individually for size and copied to the same size paper as originals.
Same Size Copies	Top Page Direction	Long Edge Left, Short Edge Left	Select the original orientation of the first page.

Sending/Storing

Item	Value	Description
Mixed Size Originals	Off	
	Same Width	Scans and sends multiple sheets of the same width using the document processor.
	Different Width	Scans and sends multiple sheets of different width using the document processor.

Supported Combinations of Originals

Same Width

When the original widths are the same, the combinations of originals that can be placed are as follows.



NOTE

When mixing the original sizes as using the following combination: Folio and A4-R, make sure to set "Auto Detect Original Size" to [On] for "Folio". For details, refer to [Auto Detect Original Size on page 8-11](#).

- B4 and B5
- Ledger and Letter (A3 and A4)
- Legal and Letter-R (Folio and A4-R)

Example: B4 and B5

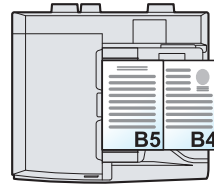
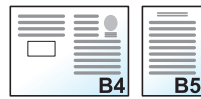

Different Width (Available for metric models only)

The supported combinations of originals are as follows.

NOTE

- Up to 30 sheets can be placed in the document processor.
- When mixing the original sizes as using the following combination: A4-R, B5-R, and Folio, make sure to set "Auto Detect Original Size" to [On] for "Folio". For details, refer to [Auto Detect Original Size on page 8-11](#).

- A3, B4, A4, B5
- B4, A4-R, B5
- A4-R, B5-R, Folio

Example: A3, B4, A4, B5

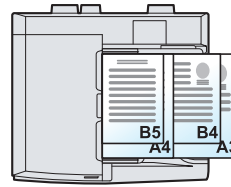

IMPORTANT

When placing originals of different width, arrange the originals so that their left sides and top sides are aligned, and place the originals in alignment with the far width guide. If the originals are not aligned in this way, they may not be scanned correctly, and skewing or original jams may result.

Selecting How to Copy Originals

Set the paper size (copy size) when printing scanned document. Select whether you wish to create individual copies on different size paper matching the original sizes or to produce all copies on the same size paper.

NOTE

This function is available regardless of whether originals have the same width or not.

Mixed Size Copies

Originals are detected individually for size and copied to the same size paper as originals.



Same Size Copies

Originals are all copied to the same size paper.



Original Orientation



Org./Paper/
Finishing



Org./Sending
Data Format



Functions



Functions

Select the orientation of the original document top edge to scan correct direction.

To use any of the following functions, the document's original orientation must be set.

- Zoom (XY Zoom)*
- Duplex*
- Margin/Centering*
- Border Erase
- Combine*
- Memo mode*
- Page #*
- Booklets*
- Stapling/Punch (optional feature)*
- 2-sided/Book Original
- Text Stamp*
- Bates Stamp*

* When making copies



NOTE

If [On] is selected in the setting for [Orientation Confirmation \(page 8-16\)](#) in System Menu, the selection screen for original orientation appears when you select any of the above functions.

Select original orientation from [Top Edge on Top] or [Top Edge on Left].

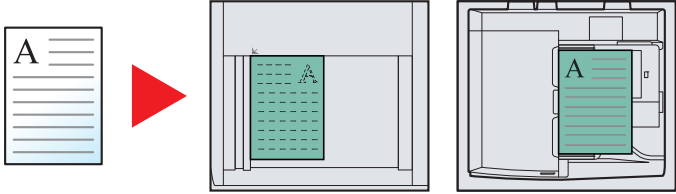
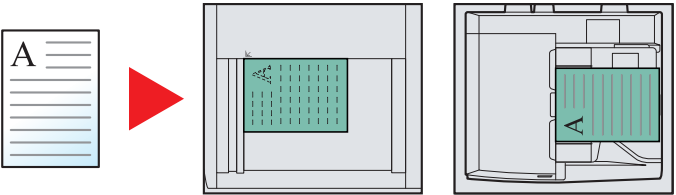
Item	Image
<p>Top Edge on Top</p>	 <p style="text-align: center;">Original Original orientation</p>
<p>Top Edge on Left</p>	 <p style="text-align: center;">Original Original orientation</p>



NOTE

The default setting for Original Orientation can be changed. Refer to [Orientation Confirmation on page 8-16](#) for details.

Fold



Org./Paper/
Finishing



Functions



Functions

Folds the finished documents.

Select the fold method.

The following folding options and orientations are available.

Original orientation			Orientation: Landscape	Orientation: Portrait
Item				
Bi-Fold				
Saddle Stitch				
Tri-Fold	Inside	R to L/B to T		
		L to R/T to B		
	Outside	R to L/B to T		
		L to R/T to B		

NOTE

Folding requires the optional 4,000-Sheet Finisher and the folding unit.

For details on paper sizes and numbers of sheets that can be folded, refer to [Center-Folding Unit \(Option\) on page 11-30](#).

Collate/Offset



Org./Paper/
Finishing







Functions

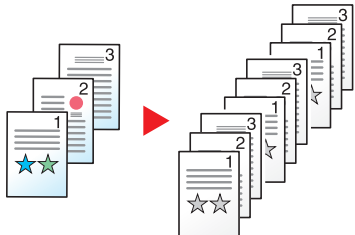
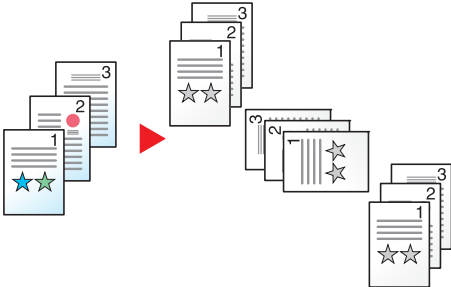

Functions

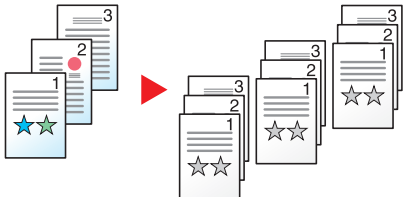
Offsets the output by page or set.

Item	Image	Description
Collate		<p>Scans multiple originals and delivers complete sets of copies as required according to page number.</p>
Offset	<p>Without Document Finisher (Option)</p> 	<p>When offsetting is used, printed copies are produced after rotating each set (or page*) by 90 degrees.</p> <p> NOTE To use offsetting, the same size of paper as the selected paper tray must be loaded in a different orientation in a different paper tray. The paper sizes supported in Offset are A4, B5, Letter and 16K.</p>
	<p>With Document Finisher (Option)</p> 	<p>When you use offsetting, printed copies are segregated after each set of copies (or after each page*).</p> <p> NOTE The optional 1,000-Sheet Finisher or 4,000-Sheet Finisher is required. The paper sizes supported in Offset are A3, B4, A4, B5, Letter, Legal, Ledger, Oficio II, 8K, 16K, 216 x 340 mm and Folio.</p>

* If [Off] is selected for "Collate" setting, [Each Page] appears. When [On] is selected, [Each Set] appears.

Staple/Punch



Staple

Staples the finished documents. The staple position can be selected.

Item	Value	Description
Staple	Top Left	Select the staple position. For details on original orientation and staple position, refer to Original Orientation and Staple Position on page 6-18 .
	Top Right	
	2 staples Left	
	2 staples Top	
	2 staples Right	
	Saddle Stitch	Select whether to fold the finished documents in two with staples in the center. When placing originals, be sure to place the cover page at the bottom. For details on saddle stitching, refer to Booklet on page 6-35 .
Original Orientation	Top Edge on Top, Top Edge on Left	Select the orientation of the original document top edge to scan correct direction. Press [Original Orientation] to choose orientation of the originals, either [Top Edge on Top] or [Top Edge on Left]. Then press [OK].

NOTE

Stapling requires the optional 1,000-Sheet Finisher or 4,000-Sheet Finisher. Note also that saddle stitching (center stapling) requires the folding unit.
For details on paper sizes and numbers of sheets that can be stapled, refer to [1,000-Sheet Finisher \(Option\) on page 11-28](#) or [4,000-Sheet Finisher \(Option\) on page 11-29](#).

Original Orientation and Staple Position

Original orientation	Top Edge on Top		Top Edge on Left	
Paper orientation 				
Cassette paper load direction 				
Cassette paper load direction 				

NOTE

B5-R and 16K-R "one staple" is not diagonal.

Mixed Size Stapling

Even with mixed paper sizes, if the sizes have the same width or same length as shown in the combinations below, the output can be stapled. Up to 30 sheets can be stapled.

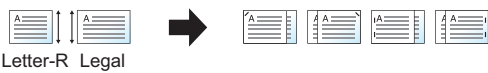
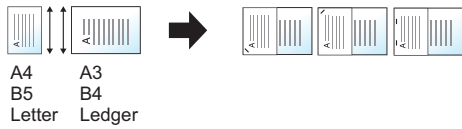

- A3 and A4
- B4 and B5
- Ledger and Letter
- Ledger and Letter-R
- 8K and 16K



NOTE

When performing Mixed Size Stapling, refer to [Mixed Size Originals on page 6-13](#).

Punch

Punches holes in sets of finished documents.







NOTE

- The optional document finisher (1,000-Sheet Finisher or 4,000-Sheet Finisher) and punching unit are required.
- For details on paper sizes that can be punched, refer to [Hole Punch Unit \(Option\) on page 11-29](#).
- The inch model provides two-hole and three-hole punching. The metric model provides two-hole and four-hole punching.

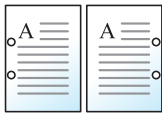
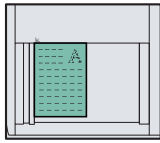
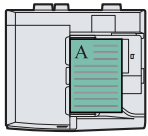
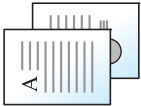
Item	Value	Description
Punch	2 holes Left	Select the position of punch holes. For details on original orientation and position of punch holes, refer to Original Orientation and Punch Hole Position on page 6-20 .
	2 holes Top	
	2 holes Right	
	3 holes Left	
	3 holes Top	
	3 holes Right	
	4 holes Left	
	4 holes Top	
	4 holes Right	
Original Orientation	Top Edge on Top, Top Edge on Left	Select the orientation of the original document top edge to scan correct direction. Press [Original Orientation] to choose orientation of the originals, either [Top Edge on Top] or [Top Edge on Left]. Then press [OK].

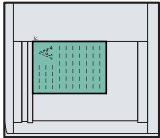
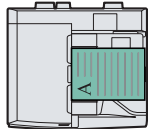
Original Orientation and Punch Hole Position

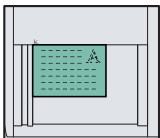
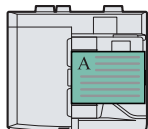
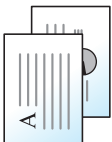
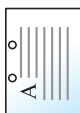
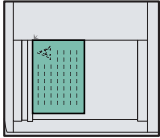
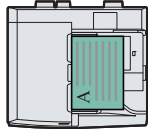
Image		Original orientation	
Original	Print results	Glass platen	Document processor
			
			
			
			

 **NOTE**

The inch model provides two-hole and three-hole punching. The metric model provides two-hole and four-hole punching.

Paper Output



Specify the output tray.

Item	Description
Inner Tray	Inner tray of the machine (where copies are stored) (Can be selected when the optional 1,000-Sheet Finisher or 4,000-Sheet Finisher is not installed.)
Finisher Left Tray, Finisher Top Tray	Tray of the optional 1,000-Sheet Finisher
Tray A, Tray B, Tray C	Trays A to C in the optional 4,000-Sheet Finisher
Right Tray	Optional right job separator
Job Separator	Optional inner job separator (Can be selected when the optional 1,000-Sheet Finisher or 4,000-Sheet Finisher is not installed.)
Tray 1 to 7	Trays 1 to 7 in the optional mailbox (tray 1 is the top tray)

NOTE

- The setting for this function can be configured only when the optional job separator and/or document finisher (1,000-Sheet Finisher or 4,000-Sheet Finisher) are installed.
- The default setting for Paper Output can be changed. For details, refer to [Paper Output on page 8-16](#).
- When [Heavy 3] (164 g/m² -) or higher is set in Paper Weight and Mailbox (Option) is set for the output destination, the output destination is automatically changed to a tray that can be used.

Density



Adjust density using 7 or 13 levels.

Adjust density pressing [-3] (Lighter) to [+3] (Darker). You can change the density level [-3] (Lighter) to [+3] (Darker) in half-steps.



Original Image



Select original image type for best results.

Copying/Printing

Item	Value	Description
Text+Photo*	Printer Output	Best for mixed text and photo documents printed on this machine originally.
	Book/Magazine	Best for mixed text and photos printed in a magazine, etc.
Photo	Printer Output	Best for photos printed on this machine originally.
	Book/Magazine	Best for photos printed in a magazine, etc.
	Photo Paper	Best for photos taken with a camera.
Text	Off (Light Text/Fine Line)	Best for documents that are mostly text and were originally printed on this machine.
	On (Light Text/Fine Line)	Sharply renders pencil text and fine lines.
Graphic/Map	Printer Output	Best for maps and diagrams printed on this machine originally.
	Book/Magazine	Best for maps and diagrams printed in a magazine.

* If gray text is not printed completely using [Text + Photo], selecting [Text] may improve the result.

Sending/Storing

Item	Description
Text+Photo	Best for mixed text and photo documents.
Photo	Best for photos taken with a camera.
Text*	Sharply renders pencil text and fine lines.

* The setting "for OCR" can be configured. (Value: [Off] / [On]) When [On] is selected, scanning produces an image that is suitable for OCR. This function is only available when Color Selection is set to Black and White. For details, refer to [Color Selection on page 6-23](#). The setting "for OCR" can be configured. When [On] is selected, scanning produces an image that is suitable for OCR. This function is only available when Color Selection is set to Black and White.

EcoPrint



EcoPrint saves toner when printing. Use this function for test prints or any other occasion when high quality print is not required. Adjustment can be made in 5 levels.

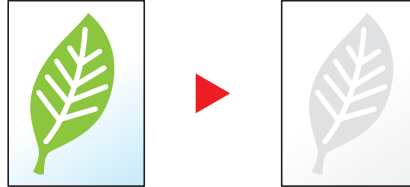

Item	Value	Description
Off		
On	[1] (Low) to [5] (High)	Adjust the Toner Save Level.

Color Selection



Select the color mode setting.

Item	Description
Auto Color (Color/Gray)	Automatically recognizes whether the document is color or black and white, and scan color documents in Full Color and black and white documents in Grayscale.
Auto Color (Color/B & W)	Automatically recognizes whether the document is color or black and white, and scan color documents in Full Color and black and white documents in Black and White.
Full Color	Scans the document in full color.
Grayscale	Scans the document in grayscale. Produces a smooth, detailed image.
Black & White	Scans the document in black and white.

Sharpness



Adjusts the sharpness of image outlines.

When copying penciled originals with rough or broken lines, clear copies can be taken by adjusting sharpness toward "Sharpen". When copying images made up of patterned dots such as magazine photos, in which moire* patterns appear, edge softening and weakening of the moire effect can be obtained by setting the sharpness toward "Blur".

When [All] is selected, press [-3] to [3] (Blur - Sharpen) to adjust the sharpness.

When [Text/Fine Line] is selected, press [0] to [3] (Normal - Sharpen) to adjust the sharpness.

Less Sharp



Original



More Sharp



Item	Value	Description
All	1 to 3 (Sharpen)	Emphasizes the image outline.
	-1 to -3 (Blur)	Blurs the image outline. Can weaken a Moire* effect.
Text/Fine Line	0 to 3 (Normal - Sharpen)	Makes letters and lines appear sharper. Only text and fine lines are emphasized.

* Patterns that are created by irregular distribution of halftone dots.

Background Density Adj.

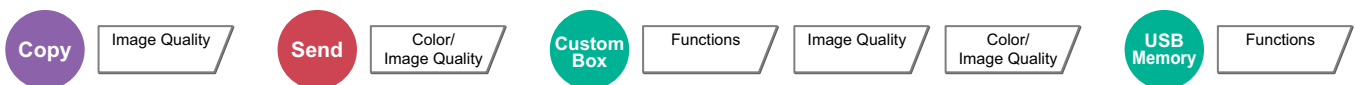

Removes dark background from originals, such as newspapers. This feature is used with full color and auto color. Background Density Adjust is disabled if Auto Color detects black and white originals.

If the ground color is obtrusive, select [Auto]. If [Auto] does not remove the ground color, select [Manual] and adjust the density of the ground color.

Item	Description
Off	Does not adjust the ground color.
Auto	Automatically adjusts the background density based on the original.
Manual	Manually adjust the density in 5 levels. When [Manual] is selected, press [1] to [5] (Lighter - Darker) to adjust the background density.

Prevent Bleed-thru



Image Quality



Color/
Image Quality



Functions

Image Quality

Color/
Image Quality



Functions

Hides background colors and image bleed-through when scanning thin original.
(Value: [Off] / [On])



Zoom



Layout/Edit



Advanced Setup



Functions



Functions

Adjust the zoom to reduce or enlarge the image.

Copying

The following zoom options are available.

Auto

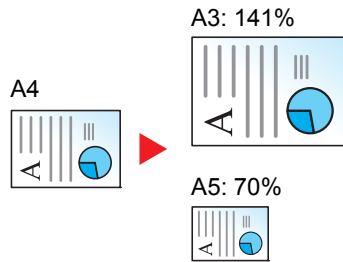

Adjusts the image to match the paper size.

Standard Zoom

Reduces or enlarges at preset magnifications.

Model	Zoom Level (Original Copy)	Model	Zoom Level (Original Copy)
Inch Models	Auto 400% (Max.) 200% (STMT >> Ledger) 154% (STMT >> Legal) 129% (Letter >> Ledger) 121% (Legal >> Ledger) 100% 78% (Legal >> Letter) 77% (Ledger >> Legal) 64% (Ledger >> Letter) 50% (Ledger >> STMT) 25% (Min.)	Metric Models	Auto 400% (Max.) 200% (A5 >> A3) 141% (A4 >> A3, A5 >> A4) 127% (Folio >> A3) 106% (11×15" >> A3) 100% 90% (Folio >> A4) 75% (11×15" >> A4) 70% (A3 >> A4, A4 >> A5) 50% 25% (Min.)
		Metric Models (Asia Pacific)	Auto 400% (Max.) 200% (A5 >> A3) 141% (A4 >> A3, B5 >> B4) 122% (A4 >> B4, A5 >> B5) 115% (B4 >> A3, B5 >> A4) 100% 86% (A3 >> B4, A4 >> B5) 81% (B4 >> A4, B5 >> A5) 70% (A3 >> A4, B4 >> B5) 50% 25% (Min.)

Zoom Entry

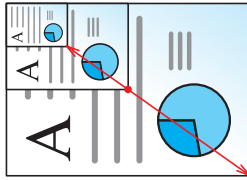

Manually reduces or enlarges the original image in 1% increments between 25% and 400%.

XY Zoom

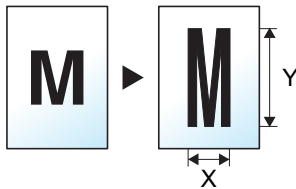

Select vertical and horizontal magnifications individually. Magnifications can be set in 1% increments between 25% and 400%.

Item	Value	Description
Standard Zoom	<p>Metric</p> <p>[# Keys] 25 to 400% (in 1% increments)</p> <p>100%, Auto, 400% Max., 200% A5>>A3, 141% A4>>A3 B5>>B4, 127% Folio>>A3, 106% 11x15">>A3, 90% Folio>>A4, 75% 11x15" >>A4, 70% A3>>A4 A4>>A5, 50%, 25% Min.</p> <p>Metric (Asia Pacific)</p> <p>[# Keys] 25 to 400% (in 1% increments)</p> <p>100%, Auto, 400% Max., 200% A5>>A3, 141% A4>>A3 B5>>B4, 122% A4>>B4 A5>>B5, 115% B4>>A3 B5>>A4, 86% A3>>B4 A4>>B5, 81% B4>>A4 B5>>A5, 70% A3>>A4 B4>>B5, 50%, 25% Min.</p> <p>Inch</p> <p>[# Keys] 25 to 400% (in 1% increments)</p> <p>Auto, 100%, 400% Max., 200% STMT>>Ledger, 154% STMT>>Legal, 129% Letter>>Ledger, 121% Legal>>Ledger, 78% Legal>>Letter, 77% Ledger>>Legal, 64% Ledger>>Letter, 50% Ledger>>STMT, 25% Min.</p>	<p>Select a preset ratio.</p> <p>Press [Auto] to use Auto Zoom.</p> <p>Press [+] or [-] to change the displayed magnification as desired. Press [# Keys] to use the numeric keys for entry.</p>
XY Zoom	<p>X: 25 to 400% (in 1 mm increments)</p> <p>Y: 25 to 400% (in 1 mm increments)</p>	<p>Select vertical and horizontal magnifications individually.</p> <p>Press [+] or [-] to change the displayed magnifications of "X" (horizontal) and "Y" (vertical).</p> <p>Press [# Keys] to use the numeric keys for entry.</p>
	Original Orientation	<p>Top Edge on Top, Top Edge on Left</p> <p>Select the orientation of the original document top edge to scan correct direction.</p> <p>Press [Original Orientation] to choose orientation of the originals, either [Top Edge on Top] or [Top Edge on Left]. Then press [OK].</p>

Printing/Sending/Storing

Item	Description
100%	Reproduces the original size.
Auto	Reduces or enlarges original to printing/sending/storing size.



NOTE

- To reduce or enlarge the image, select the paper size, sending size, or storing size.



[Paper Selection \(page 6-12\)](#)

[Sending Size \(page 6-57\)](#)

[Storing Size \(page 6-64\)](#)

- Some combinations of original size and paper size or sending size may cause the image to be positioned at the edge of the paper. To center the original vertically and horizontally on the page, use the Centering function described in [Margin/Centering, Margin, Centering on page 6-32](#).

Combine



Layout/Edit



Functions

Combines 2 or 4 original sheets into 1 printed page. You can select the page layout and the type of boundary lines around the pages.

The following types of the boundary lines are available.

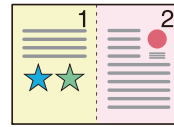

None

Solid Line

Dotted Line

Positioning Mark

Press [2 in 1] or [4 in 1], and select the page layout from "Layout".

Item		Value	Description
Off			
2 in 1	Layout	L to R/T to B, R to L/B to T	Select the page layout of scanned originals.
	Border Line	None, Solid Line, Dotted Line, Positioning Mark	Select the boundary line type. Press [Border Line] to select the page boundary line, and press [OK].
	Original Orientation	Top Edge on Top, Top Edge on Left	Select the orientation of the original document top edge to scan correct direction. Press [Original Orientation] to choose orientation of the originals, either [Top Edge on Top] or [Top Edge on Left]. Then press [OK].
4 in 1	Layout	Right then Down, Left then Down, Down then Right, Down then Left	Select the page layout of scanned originals.
	Border Line	None, Solid Line, Dotted Line, Positioning Mark	Select the boundary line type. Press [Border Line] to select the page boundary line, and press [OK].
	Original Orientation	Top Edge on Top, Top Edge on Left	Select the orientation of the original document top edge to scan correct direction. Press [Original Orientation] to choose orientation of the originals, either [Top Edge on Top] or [Top Edge on Left]. Then press [OK].

Layout image

Item		Image
2 in 1	L to R/T to B	
	R to L/B to T	
4 in 1	Right then Down	
	Left then Down	
	Down then Right	
	Down then Left	

 **NOTE**

The paper sizes supported in Combine mode are A3, A4-R, A4, A5-R, B4, B5-R, B5, Folio, 216 x 340 mm, Ledger, Letter-R, Letter, Legal, Statement-R, Oficio II, 8K, 16K-R and 16K.

When placing the original on the platen, be sure to copy the originals in page order.

Margin/Centering, Margin, Centering



Layout/Edit



Advanced Setup



Functions



Functions

Copying/Printing

Add margins (white space). In addition, you can set the margin width and the back page margin.

Centering: Centers the original image on the paper when copying onto paper different from the original size.



NOTE

The default setting for margin width can be changed. For details, refer to [Margin Default on page 8-18](#).

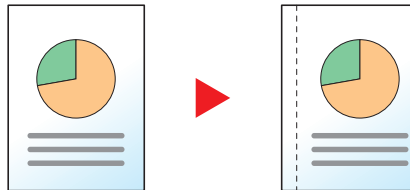

Item		Value	Description
Off			
Margin	Left/Right	Metric: -18 mm to +18 mm (in 1 mm increments)	Set the margin width.* ¹ Use [+] or [-] to enter the margins for "Left/Right" and "Top/Bottom". Press [# Keys] to use the numeric keys for entry.
	Top/Bottom	Inch: -0.75 to +0.75" (in 0.01" increments)	
	Back Page	Auto, Manual	For duplex copying, press [Back Page] and select [Auto] or [Manual]. When [Auto] is selected, an appropriate margin is applied automatically on the rear page depending on a margin specified for the front page and a binding orientation. When [Manual] is set, you can set a different margin than the front on the back. Set the margin in the screen that is displayed. The setting selections are the same as for the front.
	Original Orientation	Top Edge on Top, Top Edge on Left	Select the orientation of the original document top edge to scan correct direction. Press [Original Orientation] to choose orientation of the originals, either [Top Edge on Top] or [Top Edge on Left]. Then press [OK].
Centering*²	Original Orientation	Top Edge on Top, Top Edge on Left	Select the orientation of the original document top edge to scan correct direction. Press [Original Orientation] to choose orientation of the originals, either [Top Edge on Top] or [Top Edge on Left]. Then press [OK].

*1 The input units can be changed in System Menu. For details, refer to [Measurement on page 8-14](#).

*2 Not displayed when printing from removable memory.

Sending/Storing

When you have sent/stored the original after specifying the original size and sending size, depending on these sizes, a margin is created at the bottom, left, or right side of paper. By using the Centering function, the image is placed with a margin equally created for all edges.

(Value: [Off] / [On])

Border Erase



Erases the black border that forms around the image. The following modes are available.

Border Erase Sheet

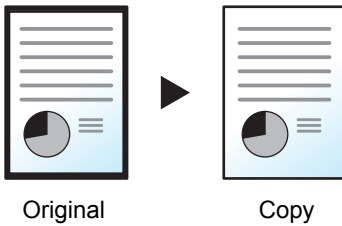

Erases black borders around the single sheet original.

Border Erase Book

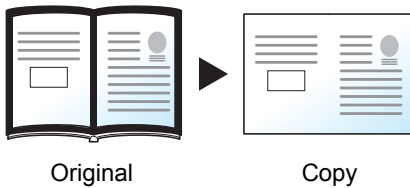

Erases black borders around the edges and in the middle of the original such as a thick book. You can specify the widths individually to erase the borders around the edges and in the center of the book.

Individual Border Erase

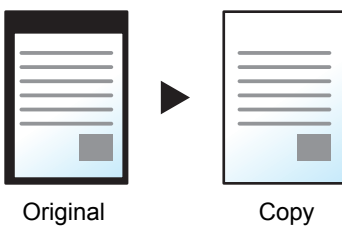

You can specify border erase widths individually for all edges.

NOTE

- The default setting for border erase width can be changed. For details, refer to [Border Erase Default on page 8-17](#).
- The default width for back page can be changed. For details, refer to [Border Erase to Back Page on page 8-17](#).

Item		Value	Description
Border Erase Sheet	Border	Metric: 0 mm to 50 mm (in 1 mm increments) Inch: 0.00 to 2.00" (in 0.01" increments)	Set the border erase width.* Set the value by pressing [+] or [-]. Press [# Keys] to use the numeric keys for entry.
	Back Page	Same as Front Page, Do Not Erase	For 2-sided originals, press [Back Page] and then press [Same as Front Page] or [Do Not Erase].
Border Erase Book	Border	Metric: 0 mm to 50 mm (in 1 mm increments)	Set the border erase width.* Set the value by pressing [+] or [-]. Press [# Keys] to use the numeric keys for entry.
	Gutter	Inch: 0.00 to 2.00" (in 0.01" increments)	
	Back Page	Same as Front Page, Do Not Erase	For 2-sided originals, press [Back Page] and then press [Same as Front Page] or [Do Not Erase].
Individual Border Erase	Top	Metric: 0 mm to 50 mm (in 1 mm increments) Inch: 0.00 to 2.00" (in 0.01" increments)	Set the border erase width.* Set the value by pressing [+] or [-]. Press [# Keys] to use the numeric keys for entry.
	Bottom		
	Left		
	Right		
	Back Page	Same as Front Page, Do Not Erase	For 2-sided originals, press [Back Page] and then press [Same as Front Page] or [Do Not Erase].
	Original Orientation	Top Edge on Top, Top Edge on Left	Select the orientation of the original document top edge to scan correct direction. Press [Original Orientation] to choose orientation of the originals, either [Top Edge on Top] or [Top Edge on Left]. Then press [OK].

* The input units can be changed in System Menu. For details, refer to [Measurement on page 8-14](#).

Booklet



Layout/Edit



Functions

The Booklet option allows you to copy sheet originals and produce booklets such as small brochures or pamphlets. A booklet, such as a magazine, is made by folding at the center.

You can print the cover page onto colored paper or thick paper. Paper for the cover is supplied from the multi purpose tray. To feed the cover paper from the cassette, refer to [Paper Source for Cover on page 8-12](#).

NOTE
Using the optional 4,000-Sheet Finisher and the folding unit enables you to saddle stitch your copies (fold them in two with staples in the center). Supported paper sizes are A3, B4, A4-R, Ledger, Legal, Letter-R, and 8K.

Type of original	Original size	Paper size
One-sided original, Two-sided original	All*	A3, B4, A4, A4-R, B5, B5-R, Ledger, Legal, Letter and Letter-R
Book Original	A3, B4, A4-R, B5-R, A5-R, Ledger, Letter-R and 8K	

* Except for custom sized originals.

Binding on the left side

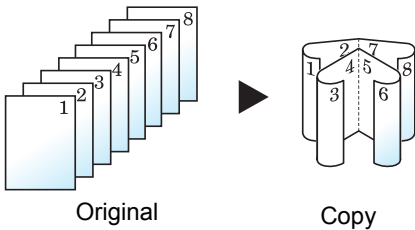

The folded copies can be read from left to right.

Binding on the right side

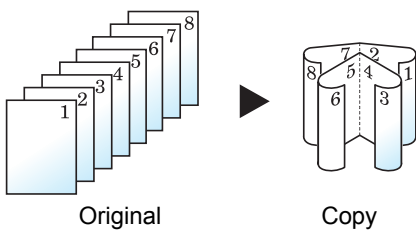

The folded copies can be read from right to left.

Top binding

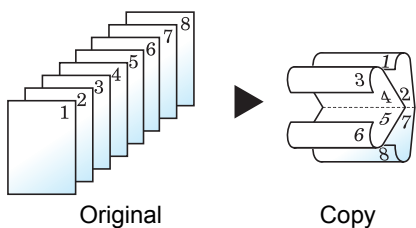

The folded copies can be read from top to bottom.

Item		Value	Description	
Off				
1-sided>> Booklet	Finishing	Binding Left, Binding Right, Binding Top	Select the binding orientation of copies.	
	Cover	Off		
		Cover: Front Cover Print Setting	Not Print, Front Only, Back Only, Duplex	Select whether to add the cover. Select the printing method for the cover to be inserted. Press [Cover], and then [Cover], and specify the print setting for the cover to be inserted. Select from [Not Print], [Back Only], [Front Only], and [Duplex], and press [OK].
		Cover: Back Cover Print Setting	Not Print, Front Only, Back Only, Duplex	Select from [Not Print], [Back Only], [Front Only], and [Duplex], and press [OK].
	Staple/Fold	Fold Only, Saddle Stitch	To fold finished copies in half, press [Staple/ Fold] and then press [Fold Only]. To use saddle stitching, press [Staple/Fold] and then press [Saddle Stitch].	
Original Orientation	Top Edge on Top, Top Edge on Left	Select the orientation of the original document top edge to scan correct direction. Press [Original Orientation] to choose orientation of the originals, either [Top Edge on Top] or [Top Edge on Left]. Then press [OK].		
2-sided>> Booklet	Original	Binding Left/Right, Binding Top	Select the binding direction of originals.	
	Finishing	Binding Left, Binding Right, Binding Top	Select the binding orientation of copies.	
	Cover	Off		
		Cover: Front Cover Print Setting	Not Print, Front Only, Back Only, Duplex	Select whether to add the cover. Select the printing method for the cover to be inserted. Press [Cover], and then [Cover], and specify the print setting for the cover to be inserted. Select from [Not Print], [Back Only], [Front Only], and [Duplex], and press [OK].
		Cover: Back Cover Print Setting	Not Print, Front Only, Back Only, Duplex	Select from [Not Print], [Back Only], [Front Only], and [Duplex], and press [OK].
Staple/Fold	Fold Only, Saddle Stitch	To fold finished copies in half, press [Staple/ Fold] and then press [Fold Only]. To use saddle stitching, press [Staple/Fold] and then press [Saddle Stitch].		
Original Orientation	Top Edge on Top, Top Edge on Left	Select the orientation of the original document top edge to scan correct direction. Press [Original Orientation] to choose orientation of the originals, either [Top Edge on Top] or [Top Edge on Left]. Then press [OK].		

	Item	Value	Description
Book>>Booklet	Original	Binding Left, Binding Right	Select the binding direction of originals.
	Finishing	Binding Left, Binding Right	Select the binding orientation of copies.
	Cover	Off, Cover	Select whether to add the cover. Press [Cover] to select [Cover], and press [OK].
	Staple/Fold	Fold Only, Saddle Stitch	To fold finished copies in half, press [Staple/ Fold] and then press [Fold Only]. To use saddle stitching, press [Staple/Fold] and then press [Saddle Stitch].
	Original Orientation	Top Edge on Top, Top Edge on Left	Select the orientation of the original document top edge to scan correct direction. Press [Original Orientation] to choose orientation of the originals, either [Top Edge on Top] or [Top Edge on Left]. Then press [OK].

**NOTE**

- The number of sheets that can be folded or Saddle Stitch stapled varies depending on paper weight. For details, refer to [Center-Folding Unit \(Option\) on page 11-30](#).
- When placing the original on the platen, be sure to place the originals in page order.

Duplex



Layout/Edit



Functions



Functions

Produces two-sided copies.

You can also create single-sided copies from two-sided originals or originals with facing pages such as books.

The following modes are available.

One-sided to Two-sided

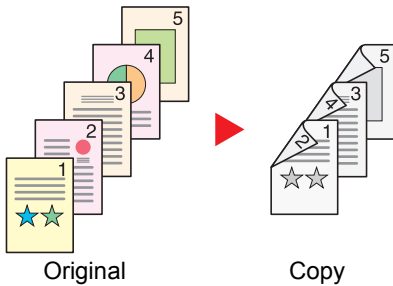

Produces two-sided copies from one-sided originals. In case of an odd number of originals, the back side of the last copy will be blank.

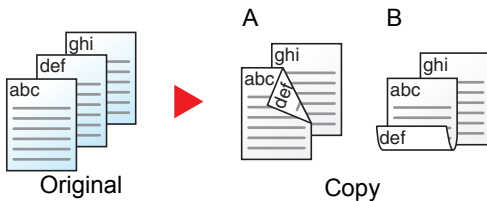

The following binding options are available.

A Original Left/Right to Binding Left/Right: Images on the second sides are not rotated.

B Original Left/Right to Binding Top: Images on the second sides are rotated 180 degrees. Copies can be bound on the top edge, facing the same orientation when turning the pages.

Two-sided to One-sided

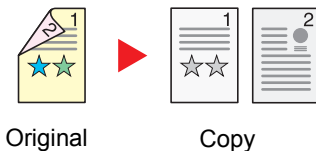

Copies each side of a two-sided original onto two individual sheets. The optional document processor is required.

The following binding options are available.

- Binding Left/Right: Images on the second sides are not rotated.
- Binding Top: Images on the second sides are rotated 180 degrees.

Two-sided to Two-sided

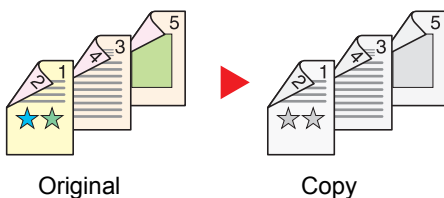

Produces two-sided copies from two-sided originals. The optional document processor is required.

NOTE

The paper sizes supported in Two-sided to Two-sided mode are A3, B4, A4, A4-R, B5, B5-R, A5-R, Ledger, Legal, Letter, Letter-R, Executive, Statement-R, Oficio II, 216 x 340 mm and Folio.

Book to One-sided



Produces a 1-sided copy of a 2-sided or open book original.

The following binding options are available.

Binding Left: Originals with facing pages are copied from left to right.

Binding Right: Originals with facing pages are copied from right to left.

NOTE

The original sizes supported in Book to One-sided mode are Ledger, Letter-R, A3, A4-R, A5-R, B4, B5-R and 8K.

The supported paper sizes are A4, B5, Letter and 16K. You may change paper size and reduce or enlarge copy to match that size.

Book to Two-sided

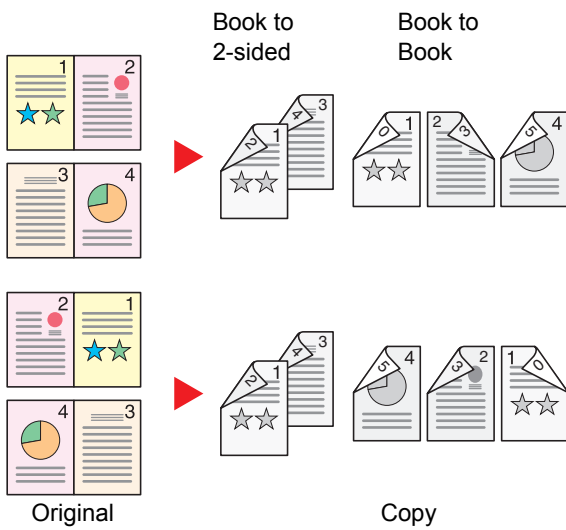

Produces two-sided copies from an open book original with facing pages.

NOTE

The original sizes supported in Book to Two-sided mode are A3, B4, A4-R, B5-R, A5-R, Ledger, Letter-R and 8K.

The supported paper sizes are A4, B5 and Letter.

Copying

Prints 1-sided or open book originals to 2-sided, or 2-sided or open book originals to 1-sided. Select the binding orientation for original and finished documents.

Item		Value	Description
1-sided>>1-sided		—	Disables the function.
1-sided>>2-sided	Finishing	Binding Left/Right, Binding Top	Select the binding orientation of copies.
	Original Orientation	Top Edge on Top, Top Edge on Left	Select the orientation of the original document top edge to scan correct direction. Press [Original Orientation] to choose orientation of the originals, either [Top Edge on Top] or [Top Edge on Left]. Then press [OK].
2-sided>>1-sided	Original	Binding Left/Right, Binding Top	Select the binding orientation of originals.
	Original Orientation	Top Edge on Top, Top Edge on Left	Select the orientation of the original document top edge to scan correct direction. Press [Original Orientation] to choose orientation of the originals, either [Top Edge on Top] or [Top Edge on Left]. Then press [OK].
2-sided>>2-sided	Original	Binding Left/Right, Binding Top	Select the binding direction of originals.
	Finishing	Binding Left/Right, Binding Top	Select the binding orientation of copies.
	Original Orientation	Top Edge on Top, Top Edge on Left	Select the orientation of the original document top edge to scan correct direction. Press [Original Orientation] to choose orientation of the originals, either [Top Edge on Top] or [Top Edge on Left]. Then press [OK].
Book>>1-sided	Original	Binding Left, Binding Right	Select the binding direction of originals.
	Original Orientation	Top Edge on Top, Top Edge on Left	Select the orientation of the original document top edge to scan correct direction.
Book>>2-sided	Original	Binding Left, Binding Right	Select the binding direction of originals.
	Finishing	Book>>2-sided, Book>>Book	Select the desired Duplex option.
	Original Orientation	Top Edge on Top, Top Edge on Left	Select the orientation of the original document top edge to scan correct direction. Press [Original Orientation] to choose orientation of the originals, either [Top Edge on Top] or [Top Edge on Left]. Then press [OK].

When placing the original on the platen, consecutively replace each original and press the **[Start]** key.

After scanning all originals, press [Finish Scan] to start copying.

Printing

Print a document to 1-sided or 2-sided sheets.

Item	Value	Description
1-sided	—	Disables the function.
2-sided	Left/Right	Prints a 2-sided document so that the sheets are aligned properly for binding on the left or right.
	Top	Prints a 2-sided document so that the sheets are aligned properly for binding on the top.

Cover



Layout/Edit



Functions

Adds a cover to the finished copies. You can print the first page and/or the last page onto colored paper or thick paper fed from the different paper source than the regular one. The following two options are available. Paper for the cover is supplied from the multi purpose tray. To feed the cover paper from the cassette, refer to [Paper Source for Cover on page 8-12](#).

The printing method can be set for the covers. Specify a print setting for each cover.

Item		Value	Description
Front Cover		Not Print, Front Only, Back Only, Duplex	Different paper has to be inserted for the first page of the document. Select [Stop Printing], [Front Only], [Back Only], or [Duplex] for the print setting of the inserted paper.
Front and Back Covers	Front Cover Print Setting	Not Print, Front Only, Back Only, Duplex	Different paper has to be inserted for the first page and last page of the document. Select [Stop Printing], [Front Only], [Back Only], or [Duplex] for the print setting of the inserted paper.
	Back Cover Print Setting	Not Print, Front Only, Back Only, Duplex	

Form Overlay



Layout/Edit



Functions

Prints the original document overlaid with a form or image. Once you scan and register the form, the form is overlaid onto the original. You can also use a form that is already registered in the Job Box.

Place the original for the form on top of the other originals. When using the optional document processor, the first page of the originals should be placed on the top.

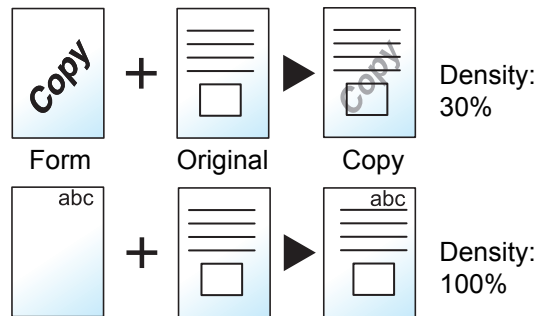

Item	Value	Description
Off		
Select Stored Form	Density	10% to 100% Specify the density of the form to be overlaid. Press [+] or [-] in "Density".
	Finishing Image	Transparent The form is overlaid on the document.
		Form on Original Image The form is placed on top of the document.
		Original Image on Form The form is placed under the document.
Select Form*	— Select the form to be overlaid from Job Box. Press [Select Form] to display the job boxes that store documents which can be used as a form. Select the desired form from the list and press [OK].	
Scan New Form	Density	10% to 100% Specify the density of the form to be overlaid. Press [+] or [-] in "Density".
	Finishing Image	Transparent The form is overlaid on the document.
		Form on Original Image The form is placed on top of the document.
		Original Image on Form The form is placed under the document.

* Form must be previously registered in Job Box. For details, refer to [Form for Form Overlay on page 5-66](#).

Page



Layout/Edit



Functions

Adds page numbers to the finished documents. The available formats for numbering are [-1-], [P.1] and [1/n]. The format [1/n] prints the total number of pages in the place of "n".

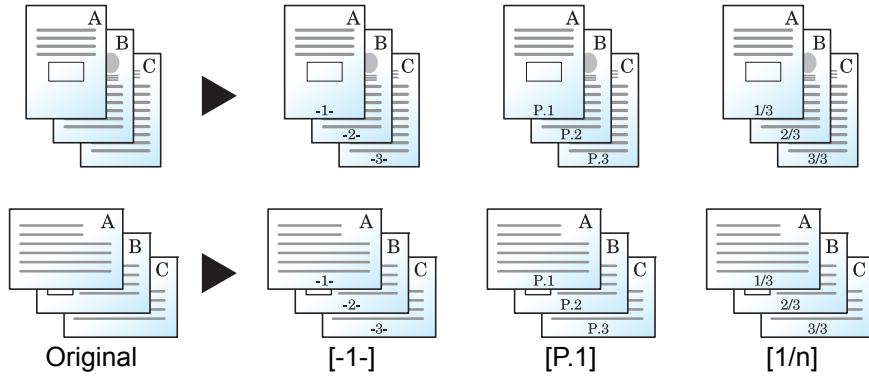

Select the numbering format from [-1-], [P.1] or [1/n].

Item		Value	Description	
Off				
-1-, P.1, 1/n	Position	Top Left, Top Middle, Top Right, Bottom Left, Bottom Middle, Bottom Right, Detail	Select the print position of page number. Press [Detail] to set the page number position using numeric values, and to set the page number position ([Same as Front Page], [Mirror Front Page]) when a page number is placed on the back side of the paper in duplex printing.	
	1st Page	1 to 10	To start page numbering from a page other than the first page, press [+] or [-] in "1st Page" to specify the starting page. Press [# Keys] to use the numeric keys for entry.	
	Start #	1 to 999	To start the numbering with a number other than 1, press [+] or [-] in "Start Number" to specify the starting number. Press [# Keys] to use the numeric keys for entry.	
	Last Page	-10 to 0	If you do not want page numbering through to the last page, press [Last Page]. Select [Manual] and use [+] or [-] to specify the final page to be numbered (a negative number of pages counting backwards from the last page), and then press [OK]. Specify the desired number up to -10. Press [# Keys] to use the numeric keys for entry.	
	Font	Size	Font sizes registered in Text (Text Stamp) on page 8-20 are displayed.	Set the font size of page number.
		Style	None, Bold, Italic, Bold/Italic	Set the font style of page number.
		Font	Courier, Letter Gothic	Set the font of page number.
		Color	Black, White	Set the color of page number.
		Density	10 to 100% (in 10% increments)	Set the density of the color of page number. Set the value by pressing [+] or [-].
		Display Pattern	Transparent, Clipping, Overwrite	Set the display method of page number.
	Denominator#*	Auto, Manual (1 to 999)	The total number of pages "n" in the format [1/n] can be changed manually. Press [Denominator #] and select [Manual]. Press [+] or [-] to enter the total number of pages and press [OK]. Press [# Keys] to use the numeric keys for entry.	
Original Orientation	Top Edge on Top, Top Edge on Left	Select the orientation of the original document top edge to scan correct direction. Press [Original Orientation] to choose orientation of the originals, either [Top Edge on Top] or [Top Edge on Left]. Then press [OK].		

* This item appears when [1/n] is selected.

Memo Page



Delivers copies with a space for adding notes. You can also print two originals onto the same sheet with a space or add lines to indicate page boundaries.

Press [Layout A] or [Layout B] and select the page layout from "Layout".

NOTE

The paper sizes supported in Memo mode are A3, B4, A4, A4-R, B5, B5-R, A5-R, Ledger, Legal, Oficio II, 216 x 340 mm, Letter, Letter-R, Statement-R, Folio, 8K, 16K and 16K-R.

Layout A

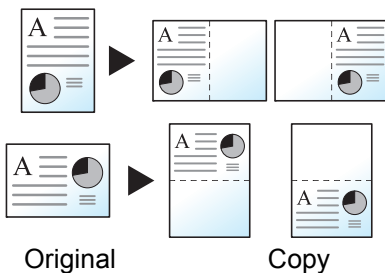

Reduces images of each original page for printing onto half of a page, leaving the other half blank for notes.

Layout B

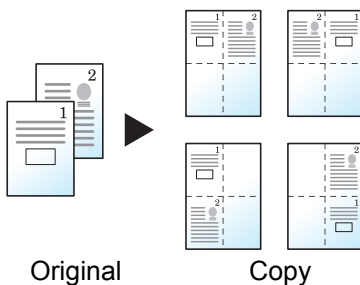

Reduces images of two original pages for printing onto half of a page, leaving the other half blank for notes.

Item	Value	Description	
Off			
Layout A	Layout	Left/Top, Right/Bottom	Select how to lay out the pages of scanned original.
	Border Line	None, Solid Line, Dotted Line, Positioning Mark	Select the boundary line type. Press [Border Line] to select the page boundary line, and press [OK].
	Original Orientation	Top Edge on Top, Top Edge on Left	Select the orientation of the original document top edge to scan correct direction. Press [Original Orientation] to choose orientation of the originals, either [Top Edge on Top] or [Top Edge on Left]. Then press [OK].
Layout B	Layout	Top L to R, Top R to L, Top L to B, Top R to B	Select how to lay out the pages of scanned original.
	Border Line	None, Solid Line, Dotted Line, Positioning Mark	Select the boundary line type. Press [Border Line] to select the page boundary line, and press [OK].
	Original Orientation	Top Edge on Top, Top Edge on Left	Select the orientation of the original document top edge to scan correct direction. Press [Original Orientation] to choose orientation of the originals, either [Top Edge on Top] or [Top Edge on Left]. Then press [OK].

Image Repeat

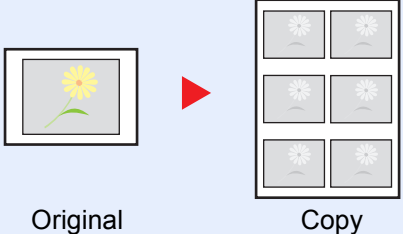
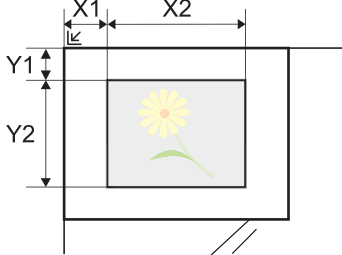
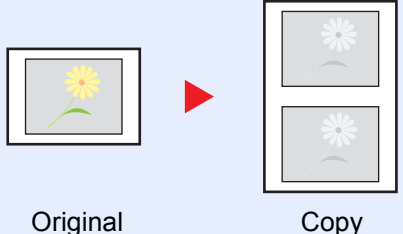

Tiles the 1 copied sheet with an original image. You can also specify the area of the original to repeat.

Item	Value	Description						
Off								
<p>Zoom Priority</p>  <p>Original → Copy</p>	<p>25 to 400% (in 1% increments)</p> <p>Specify Repeat Area</p> <table border="1"> <tr> <td colspan="2" data-bbox="676 658 1046 703">Off</td> </tr> <tr> <td data-bbox="676 703 804 898">On: Start</td> <td data-bbox="804 703 1046 898"> Metric X1: 0 to 431 mm Y1: 0 to 296 mm Inch X1: 0.00 to 16.99" Y1: 0.00 to 11.68" </td> </tr> <tr> <td data-bbox="676 898 804 1442">On: Area</td> <td data-bbox="804 898 1046 1442"> Metric X2: 1 to 432 mm Y2: 1 to 297 mm Inch X2: 0.01 to 17.00" Y2: 0.01 to 11.69" </td> </tr> </table>	Off		On: Start	Metric X1: 0 to 431 mm Y1: 0 to 296 mm Inch X1: 0.00 to 16.99" Y1: 0.00 to 11.68"	On: Area	Metric X2: 1 to 432 mm Y2: 1 to 297 mm Inch X2: 0.01 to 17.00" Y2: 0.01 to 11.69"	<p>Set the default screen. Press [+] or [-] to change the displayed magnification as desired. Press [# Keys] to use the numeric keys for entry.</p> <p>To set the area of the original to be repeated, press [On] for "Specify Repeat Area".</p> <p>Press [+] or [-] to input the area of the original to be repeated.* Press [# Keys] to use the numeric keys for entry.</p> <p>Y1: Length from top left of platen to top edge of repeat area X1: Length from top left of platen to left edge of repeat area Y2: Height of repeat area X2: Width of repeat area</p> 
Off								
On: Start	Metric X1: 0 to 431 mm Y1: 0 to 296 mm Inch X1: 0.00 to 16.99" Y1: 0.00 to 11.68"							
On: Area	Metric X2: 1 to 432 mm Y2: 1 to 297 mm Inch X2: 0.01 to 17.00" Y2: 0.01 to 11.69"							
<p>Double Copy</p>  <p>Original → Copy</p>	<p>—</p>	<p>Makes 2 copies of the same original on a single sheet.</p> <p>For example, you can double-copy an A4 original onto an A3 sheet which you then cut in half to make 2 copies that are identical to the original.</p>						

* The input units can be changed in System Menu. For details, refer to [Measurement on page 8-14](#).

Text Stamp



Layout/Edit



Advanced Setup



Functions



Functions

You can add a text stamp on the documents.



NOTE

This cannot be set when Text Stamp is set in the system settings. For details, refer to [Printing Jobs on page 8-21](#).

Copying/Printing

Item		Value	Description	
Off				
On	Stamp	Keyboard, Template 1 to 8	Press [Keyboard] and enter the text string to be printed, or select a text stamp from the displayed templates. NOTE Templates that have been set will appear. For details on registering templates, refer to Text (Text Stamp) on page 8-20 .	
	Stamp Method	Each Print Page, Each Original Page	Select the stamp method. Press [Stamp Method] and set the stamp method for text stamp.	
	Position	Top Left, Top Middle, Top Right, Middle Left, Center, Middle Right, Bottom Left, Bottom Middle, Bottom Right, Detail	Set the stamp position to be printed. Press [Position] and select the text stamp position. Press [Detail] to set the stamp position using numeric values, and to set the stamp position and angle when a stamp is placed on the back side of the paper in duplex printing.	
	Font	Size	Registered font sizes are displayed. For details on registering font sizes, refer to Font (Text Stamp) on page 8-20 .	Set the font size of text stamp.
		Character Border	Off, Circle, Rectangle, Underline	Set the character border and underline.
		Style	None, Bold, Italic, Bold/Italic	Set the font style of text stamp.
		Font	Courier, Letter Gothic	Set the font of text stamp.
		Color	Black, White	Set the color of text stamp.
		Density	10 to 100% (in 10% increments)	Set the density of text stamp color. Set the value by pressing [+] or [-].
	Display Pattern	Transparent, Clipping, Overwrite	Set the display method of text stamp.	
	Original Orientation	Top Edge on Top, Top Edge on Left	Select the orientation of the original document top edge to scan correct direction. Press [Original Orientation] to choose orientation of the originals, either [Top Edge on Top] or [Top Edge on Left]. Then press [OK].	

Sending/Storing

Item		Value	Description	
Off				
On	Stamp	Keyboard, Template 1 to 8	Press [Keyboard] and enter the text string to be printed, or select a text stamp from the displayed templates.  NOTE Templates that have been set will appear. For details on registering templates, refer to Text (Text Stamp) on page 8-20 .	
	Position	Top Left, Top Middle, Top Right, Middle Left, Center, Middle Right, Bottom Left, Bottom Middle, Bottom Right, Detail	Set the stamp position to be printed. Press [Position] and select the text stamp position. Press [Detail] to set the stamp position using numeric values, and to set the stamp angle.	
	Font	Size	Registered font sizes are displayed. For details on registering font sizes, refer to Font (Text Stamp) on page 8-20 .	Set the font size of text stamp.
		Character Border	Off, Circle, Rectangle, Underline	Set the character border and underline.
		Style	None, Bold, Italic, Bold/Italic	Set the font style of text stamp.
		Font	Courier, Letter Gothic	Set the font of text stamp.
		Color	Black, Red, Green, Blue, Cyan, Magenta, Yellow, White	Set the color of text stamp.
		Density	10 to 100% (in 10% increments)	Set the density of text stamp color. Set the value by pressing [+] or [-].
		Display Pattern	Transparent, Clipping, Overwrite	Set the display method of text stamp.
Original Orientation	Top Edge on Top, Top Edge on Left	Select the orientation of the original document top edge to scan correct direction. Press [Original Orientation] to choose orientation of the originals, either [Top Edge on Top] or [Top Edge on Left]. Then press [OK].		

Bates Stamp



Layout/Edit



Advanced Setup



Functions



Functions

You can add a bates stamp on the documents.



NOTE

This cannot be set when Text Stamp is set in the system settings. For details, refer to [Printing Jobs on page 8-21](#).

Copying/Printing

Item		Value	Description	
Off				
On	Stamp	Date, User Name, Serial Number, Numbering, Text 1, Text 2	Set the stamp to be printed. When [Text 1] or [Text 2] is selected, press [Change] below and enter the text string. If you selected [Date], press [Date Format] and select [MM/DD/YYYY], [DD/MM/YYYY], or [YYYY/MM/DD] to set the date format. To set [Numbering], press [Numbering Default] and set the starting sequence number (1 to 9999999).	
	Position	Top Left, Top Middle, Top Right, Middle Left, Center, Middle Right, Bottom Left, Bottom Middle, Bottom Right, Detail	Set the stamp position to be printed. Press [Position] and select the text stamp position. Press [Detail] to set the stamp position using numeric values, and to set the stamp position when a stamp is placed on the back side of the paper in duplex printing.	
	Font	Size	Registered font sizes are displayed. For details on registering font sizes, refer to Font (Bates Stamp) on page 8-20 .	Set the font size of bates stamp.
		Style	None, Bold, Italic, Bold/Italic	Set the font style of bates stamp.
		Font	Courier, Letter Gothic	Set the font of bates stamp.
		Color	Black, White	Set the color of the bates stamp.
		Density	10 to 100% (in 10% increments)	Set the density of bates stamp color. Set the value by pressing [+] or [-].
		Display Pattern	Transparent, Clipping, Overwrite	Set the display method of the bates stamp.
Original Orientation	Top Edge on Top, Top Edge on Left	Select the orientation of the original document top edge to scan correct direction. Press [Original Orientation] to choose orientation of the originals, either [Top Edge on Top] or [Top Edge on Left]. Then press [OK].		

Sending/Storing

Item		Value	Description	
Off				
On	Stamp	Date, User Name, Serial Number, Numbering, Text 1, Text 2	Set the stamp to be printed. When [Text 1] or [Text 2] is selected, press [Change] below and enter the text string. If you selected [Date], press [Date Format] and select [MM/DD/YYYY], [DD/MM/YYYY], or [YYYY/MM/DD] to set the date format. To set [Numbering], press [Numbering Default] and set the starting sequence number (1 to 9999999).	
	Position	Top Left, Top Middle, Top Right, Middle Left, Center, Middle Right, Bottom Left, Bottom Middle, Bottom Right, Detail	Set the stamp position to be printed. Press [Position] and select the text stamp position. Press [Detail] to specify the stamp position using numeric values.	
	Font	Size	Registered font sizes are displayed. For details on registering font sizes, refer to Font (Bates Stamp) on page 8-20 .	Set the font size of bates stamp.
		Style	None, Bold, Italic, Bold/Italic	Set the font style of bates stamp.
		Font	Courier, Letter Gothic	Set the font of bates stamp.
		Color	Black, Red, Green, Blue, Cyan, Magenta, Yellow, White	Set the color of bates stamp.
		Density	10 to 100% (in 10% increments)	Set the density of bates stamp color. Set the value by pressing [+] or [-].
	Display Pattern	Transparent, Clipping, Overwrite	Set the display method of bates stamp.	
Original Orientation	Top Edge on Top, Top Edge on Left	Select the orientation of the original document top edge to scan correct direction. Press [Original Orientation] to choose orientation of the originals, either [Top Edge on Top] or [Top Edge on Left]. Then press [OK].		

Continuous Scan

Advanced
Setup

Send

Advanced
SetupCustom
Box

Functions

USB
Memory

Functions

Scans a large number of originals in separate batches and then produce as one job. Originals will be scanned continuously until you press [Finish Scan].

Select [On] to use continuous scanning. To use Job Build, select [Job Build]. You can set the functions that appear on the screen during scanning.

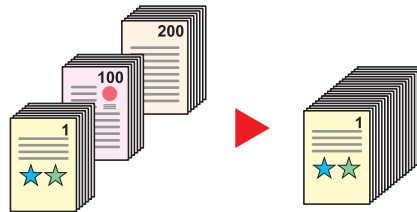

Job Build

When [Job Build] is selected when copying or printing, the binding orientation for finished documents can be selected from [Binding Left], [Binding Right] or [Binding Top].

The following functions can be selected during scanning.

Item	Description
Next Copy: On Back	In duplex copying, prints on the back side if the next page is to be printed on the front side. Press [Next Copy: On Back] to use this function.
Next Copy: On Front	In duplex copying, prints on the front side if the next page is to be printed on the back side. Press [Next Copy: On Front] to use this function.
Sheet Insertion	Inserts a blank paper in the next page. Press [Sheet Insertion] to use this function.

Auto Image Rotation

Copy

Advanced
Setup

Automatically rotates the image 90 degrees when the sizes of the original and the loaded paper matches but the orientations are different.

(Value: [Off] / [On])



NOTE

- You can select whether to rotate the image automatically in the default settings. For details, refer to [Auto Image Rotation \(Copy\) on page 8-18](#).
- When you have enabled this function, you can select how the images are rotated. For details, refer to [Auto Image Rotation Action on page 8-28](#).

Negative Image

Copy

Advanced
Setup

Inverts black and white portions of the image for printing.

(Value: [Off] / [On])

Mirror Image

Copy

Advanced
Setup

Copies the mirrored image of the original.

(Value: [Off] / [On])

Job Finish Notice



Advanced Setup



Advanced Setup



Functions



Functions

Sends E-mail notice when a job is complete.

Users can be notified of the completion of a job while working at a remote desk, saving the time spent waiting beside the machine to finish.

Example of Job Finish Notice:

To:	h_pttr@owl-net.net
Subject:	1234 Job end report mail
Job No.:	000002
Result:	OK
End Time:	Sat 02 Feb 2013 10:10:10
File Name:	doc27042005145608
Job Type:	Copy
1234	
[00:c0:ee:d0:01:14]	



NOTE

PC should be configured in advance so that E-mail can be used. For details, refer to [Command Center RX on page 2-33](#). E-mail can be sent to a single destination.

Item	Description
Off	
Address Book	Select the notification destination from the address book.
Detail	Information on the selected destination can be viewed.
Address Book	Select the notification destination on the address book screen, then press [OK].
Address Entry	Enter E-mail address directly. Press [E-mail Address], enter the address (up to 128 characters) and press [OK].

File Name Entry



Advanced Setup



Advanced Setup



Functions



Functions

Adds a file name. Additional information such as job number and date and time can also be set. You can check a job history or job status using the file name, date and time, or job number specified here.

Press [File Name], enter the file name (up to 32 characters), and press [OK].

To add date and time, press [Date and Time]. To add job number, press [Job No.]. The added information will be displayed in "Additional Info".

Priority Override



Advanced Setup



Functions



Functions

Suspends the current job and gives a new job top priority. The suspended job resumes after the other job is finished. (Value: [Off] / [On])



NOTE

This function is not available if current job was an override.

Priority override may not be available depending on the status of the current print job and memory usage. In this case, try the interrupt copy.



[Interrupt Copy \(page 5-22\)](#)

Repeat Copy



Advanced Setup

Enables additional copies in the desired quantity as necessary after a copy job is completed. For confidential documents, you can set up a password for the use of Repeat Copy. In such a case, the correct password must be entered to perform Repeat Copy.

To register a password, press [# Keys] and enter a 4-digit password.



IMPORTANT

- A Repeat Copy job is cleared when the main power switch is turned off.
- If you forget the password, Repeat Copy cannot be performed for that document. Make a note of the password beforehand if necessary.

Repeat Copy is not available when the machine is equipped with the optional Data Security Kit.

When the maximum number of Repeat Copy jobs to retain in the document box is set to 0 (zero), this function cannot be used. (Refer to [Repeat Copy Job Retention on page 8-34.](#))

You can select Repeat Copy as the default setting. For details, refer to [Repeat Copy on page 8-20.](#)

Giving a file name to a copy job will facilitate identification of the data when copying. (Refer to [File Name Entry on page 6-53.](#))

Repeat Copy

The Repeat Copy jobs are stored in the Job Box. Refer to [Outputting Repeat Copy Jobs on page 5-65](#) to print out the Repeat Copy jobs.

DP Read Action

Copy

Advanced
Setup

When the document processor is used, select the scanning operation for the document processor.

Item	Description
Speed Priority	Gives priority to scanning speed.
Quality Priority	Gives priority to image quality at a slightly slower scan speed.



NOTE

- This function is displayed when the document processor is installed.
- This feature cannot be used when [On] is selected in [Document Guard on page 8-51](#).

Skip Blank Page

Copy

Advanced
Setup

When there are blank pages in a scanned document, this function skips the blank pages and prints only pages that are not blank. When set to [High], the level at which blank paper is recognized is higher.

The machine detects blank pages, saving unnecessary printing without the need to check for blank pages in the document.

Select [Low], [Middle] or [High] in "Blank Detection Level".



NOTE

The originals with punched holes or originals printed on a colored substrate may not be recognized as blank pages.

2-sided/Book Original, Book Original

Org./Sending
Data Format

Functions







Functions

Select the type and orientation of the binding based on the original.

Item		Value	Description
1-sided		—	"2-sided/Book Original" is not set.
2-sided*	Binding	Binding Left/Right, Binding Top	Select the binding orientation of originals.
	Original Orientation	Top Edge on Top, Top Edge on Left	Select the orientation of the original document top edge to scan correct direction. Press [Original Orientation] to choose orientation of the originals, either [Top Edge on Top] or [Top Edge on Left]. Then press [OK].
Book	Binding	Binding Left, Binding Right	Select the binding orientation of originals.
	Original Orientation	Top Edge on Top, Top Edge on Left	Select the orientation of the original document top edge to scan correct direction. Press [Original Orientation] to choose orientation of the originals, either [Top Edge on Top] or [Top Edge on Left]. Then press [OK].

* Available when the optional document processor is used.

Sample image

Value		Image
2-sided	Binding Left/Right	
	Binding Top	
Book	Binding Left	
	Binding Right	

Sending Size

Org./Sending
Data Format

Functions

Select size of image to be sent.

Press [Standard Sizes 1], [Standard Sizes 2], or [Others] to select the sending size.

Item	Value	Description
Standard Sizes 1	Metric models: Same as Original Size, A3, A4, A5, A6, B4, B5, B6, Folio, 216 × 340 mm Inch models: Same as Original Size, Ledger, Letter, Legal, Statement, 11 × 15", Oficio II	Select from Same as Original Size or Standard Size.
Standard Sizes 2	Metric models: Ledger, Letter, Legal, Statement, 11 × 15", Oficio II, 8K, 16K Inch models: A3, A4, A5, A6, B4, B5, B6, Folio, 8K, 16K, 216 × 340 mm	Select from standard sizes except Standard Sizes 1.
Others	Hagaki, Oufuku hagaki	Select from Hagaki.

Relationship between Original Size, Sending Size, and Zoom

[Original Size \(page 6-11\)](#), Sending Size, and [Zoom \(page 6-26\)](#) are related to each other. For details, see the table below.

Original size and sending size are	the same	different
Original Size (page 6-11)	Specify as necessary.	Specify as necessary.
Sending Size	Select [Same as Original].	Select the desired size.
Zoom (page 6-26)	Select [100%] (or [Auto]).	Select [Auto].



NOTE

When you specify the sending size that is different from the original size, and select the zoom of [100%], you can send the image as the actual size (No Zoom).

File Format

Org./Sending
Data Format

Functions



Functions

Specify the image file format. Image quality level can also be adjusted.

Select the file format from [PDF], [TIFF], [JPEG], [XPS], and [High Comp. PDF].

When the color mode in scanning has been selected for Grayscale or Full Color, set the image quality.

If you selected [PDF] or [High Comp. PDF], you can specify encryption or PDF/A settings.

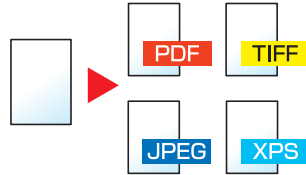

Item	Value	Color mode
PDF ^{*1*2}	1 Low Quality (High Comp.) to 5 High Quality (Low Comp.)	Auto Color (Color/Grayscale), Auto Color (Color/Black and White), Full Color, Grayscale, Black and White
TIFF	1 Low Quality (High Comp.) to 5 High Quality (Low Comp.)	Auto Color (Color/Grayscale), Auto Color (Color/Black and White), Full Color, Grayscale, Black and White
JPEG	1 Low Quality (High Comp.) to 5 High Quality (Low Comp.)	Auto Color (Color/Grayscale), Full Color, Grayscale
XPS	1 Low Quality (High Comp.) to 5 High Quality (Low Comp.)	Auto Color (Color/Grayscale), Auto Color (Color/Black and White), Full Color, Grayscale, Black and White
High Comp. PDF ^{*1*2}	Compression Ratio Priority, Standard, Quality Priority	Auto Color (Color/Grayscale), Auto Color (Color/Black and White), Full Color, Grayscale

*1 The file format can be set (**Value**: [Off] / [PDF/A-1a] / [PDF/A-1b]).

*2 You can create Searchable PDF file by running OCR on the scanned document. For details, refer to [OCR Text Recognition \(Option\) on page 6-59](#).



NOTE

- When [High Comp. PDF] is selected, you cannot adjust the image quality.
- You can use PDF encryption functions. For details, refer to [PDF Encryption Functions on page 6-60](#).
- If encryption is enabled, PDF/A settings cannot be specified.

OCR Text Recognition (Option)

When [PDF] or [High Comp. PDF] is selected for the file format, you can create Searchable PDF file by running OCR on the scanned document. Press [OCR Text Recognition], and then [On], select the language of the document, and press [OK].

Item	Description
Off	Do not create Searchable PDF file.
On	Create Searchable PDF file. Select the language to extract from the options displayed on the touch panel.
Auto Image Rotation	Rotates image automatically by recognizing text orientation. Value: Off, On



NOTE

- This function can only be used when the optional OCR Scan Activation Kit is installed.



[Scan extension kit\(A\) "OCR Scan Activation Kit" \(page 11-7\)](#)

- If the proper language is not selected, the PDF creation time may be taken or the creation may be failed. The default language can be changed in System Menu. For details, refer to [Primary OCR Language on page 8-19](#).
- If the original orientation is not correct, texts on the original cannot be recognized as texts or the PDF creation time may take some time. Check the following:
 - The original orientation is correct.
 - When setting the originals with the mixed orientation at once, [On] is selected for [Auto Image Rotation]. If you frequently use the originals with the mixed orientation, the default of [Auto Image Rotation] can be changed in System Menu. For details, refer to [Auto Image Rotation \(OCR\) on page 8-19](#).
- The accuracy of the text recognition depends on the original condition. The following condition may result in decreasing the recognition accuracy.
 - Repeatedly copied documents (as copied copy)
 - Received faxes (with low resolution)
 - Originals with the character space too narrow or wide
 - Originals with the lines on the text
 - Originals with the special fonts
 - Binding part of the book
 - A handwritten texts

PDF Encryption Functions

If you have selected PDF or High Comp. PDF for file format, you can restrict the access level for displaying, printing, and editing PDF's by assigning a secure password.

Select [PDF] or [HighComp.PDF] in [File Format], and press [Encryption].

Items that can be set vary depending on the setting selected in "Compatibility".

When [Acrobat 3.0 or later] is selected

Item		Value	Description
Password to Open Document		Off, On	Enter the password to open the PDF file. Press [Password], enter a password (up to 256 characters) and then press [OK]. Press [Confirmation] to enter the password again for confirmation, and press [OK].
Password to Edit/Print Document		Off, On	Enter the password to edit the PDF file. Press [Password], enter a password (up to 256 characters) and then press [OK]. Press [Confirmation] to enter the password again for confirmation, and press [OK]. When you have entered the password to edit/print document, you can specifically limit the operation.
Detail	Printing Allowed	Not Allowed, Allowed	Restricts printing of the PDF file.
	Changes Allowed	Not Allowed	Disables the change to the PDF file.
		Commenting	Can only add commenting.
		Page Layout except extracting Pages	Can change the page layout except extracting the pages of the PDF file.
	Any except extracting Pages	Can conduct all operations except extracting the pages of the PDF file.	
Copying of Text/ Images/Others	Disable, Enable	Restricts the copying of text and objects on the PDF file.	

When [Acrobat 5.0 or later] is selected

Item		Value	Description
Password to Open Document		Off, On	Enter the password to open the PDF file. Press [Password], enter a password (up to 256 characters) and then press [OK]. Press [Confirmation] to enter the password again for confirmation, and press [OK].
Password to Edit/Print Document		Off, On	Enter the password to edit the PDF file. Press [Password], enter a password (up to 256 characters) and then press [OK]. Press [Confirmation] to enter the password again for confirmation, and press [OK]. When you have entered the password to edit/print document, you can specifically limit the operation.
Detail	Printing Allowed	Not Allowed	Disables the printing of PDF file.
		Allowed (Low Resolution only)	Can print the PDF file only in low resolution.
		Allowed	Can print the PDF file in original resolution.
	Changes Allowed	Not Allowed	Disables the change to the PDF file.
		Inserting/Deleting/Rotating Pages	Can only insert, delete, and rotate the pages of the PDF file.
		Commenting	Can only add commenting.
	Any except extracting Pages	Can conduct all operations except extracting the pages of the PDF file.	
Copying of Text/ Images/Others	Disable, Enable	Restricts the copying of text and objects on the PDF file.	

File Separation



Creates several files by dividing scanned original data page by page, and sends the files.

(Value: [Off] / [Each Page])

Press [Each Page] to set File Separation.

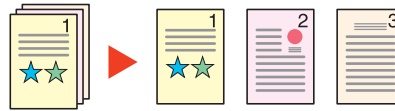

NOTE

A three-digit serial number such as "abc_001.pdf, abc_002.pdf..." is attached to the end of the file name.

Scan Resolution, Resolution



Select fineness of scanning resolution.

The selectable resolution is [600 x 600dpi], [400 x 400dpi Ultra Fine], [300 x 300dpi], [200 x 400dpi Super Fine], [200 x 200dpi Fine], or [200 x 100dpi Normal].

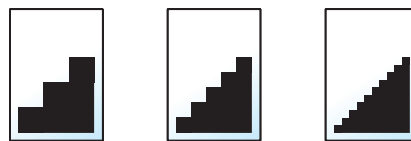

NOTE

The larger the number, the better the image resolution. However, better resolution also means larger file sizes and longer send times.

E-mail Subject/Body



Adds subject and body when sending a document.

Press [Subject] / [Body] to enter the E-mail subject/body.

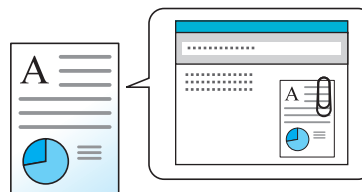

NOTE

- The subject can include up to 60 characters, and the body can include up to 500 characters.
- Press [Body 1], [Body 2], or [Body 3] to enter stored text for the body text. For details on registering templates, refer to [E-mail Subject/Body on page 8-19](#).

Send and Print



Prints a copy of the document being sent.

(Value: [Off] / [On])

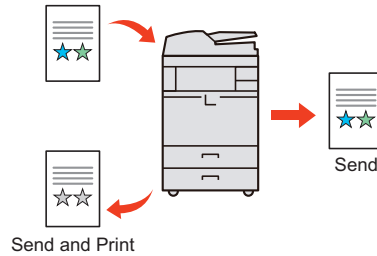

Send and Store



Stores a copy of the document being sent in a Custom Box.

(Value: [Off] / [On])

NOTE

When [On] is selected, select the Custom Box in which the copy is to be stored. If a password entry screen for the Custom Box appears, enter the password. You can view information on the selected Custom Box by pressing [Detail].



FTP Encrypted TX



Advanced Setup



Functions

Encrypts images when sending via FTP. Encryption secures the document transmission.
(Value: [Off] / [On])



NOTE

You can only change the settings by logging in with administrator privileges.

The factory default login user name and login password are set as shown below.

Model Name	Login User Name	Login Password
3501i	3500	3500
4501i	4500	4500
5501i	5500	5500

Click [[Security Settings](#)], and then [[Network Security](#)] in the Command Center RX. Be sure that "SSL" of Secure Protocol Settings is "On" and one or more effective encryption are selected in Client side settings.

For details, refer to the **Command Center RX User Guide**.

File Size Confirmation



Advanced Setup



Functions

Checks the file size before sending the original.

(Value: [Off] / [On])

Delete after Printed



Functions

Automatically deletes a document from the box once printing is complete.

Delete after Transmitted



Functions

Automatically deletes a document from the box once transmission is complete.

Storing Size



Functions



Functions

Select size of image to be stored.

Press [Standard Sizes 1], [Standard Sizes 2], or [Others] to select the storing size.

Item	Value	Description
Standard Sizes 1	Metric models: Same as Original Size, A3, A4, A5, A6, B4, B5, B6, Folio, 216 × 340 mm Inch models: Same as Original Size, Ledger, Letter, Legal, Statement, 11 × 15", Oficio II	Select from Same as Original Size or Standard Size.
Standard Sizes 2	Metric models: Ledger, Letter, Legal, Statement, 11 × 15", Oficio II, 8K, 16K Inch models: A3, A4, A5, A6, B4, B5, B6, Folio, 8K, 16K, 216 × 340 mm	Select from standard sizes except Standard Sizes 1.
Others	Hagaki, Oufuku hagaki	Select from Hagaki.

Relationship between Original Size, Storing Size, and Zoom

[Original Size \(page 6-11\)](#), Storing Size, and [Zoom \(page 6-26\)](#) are related to each other. For details, see the table below.

Original Size and the size you wish to store as are	the same	different
Original Size (page 6-11)	Specify as necessary.	Specify as necessary.
Storing Size	Select [Same as Original].	Select the desired size.
Zoom (page 6-26)	Select [100%] (or [Auto]).	Select [Auto].



NOTE

When you select Storing Size that is different from Original Size, and select the Zoom [100%], you can store the image as the actual size (No Zoom).

Encrypted PDF Password



Functions

Enter the preassigned password to print the PDF data.

Press [Password] to enter the Password, and press [OK].



NOTE

For details on entering the password, refer to [Character Entry Method on page 11-10](#).

JPEG/TIFF Print



Select the image size when printing JPEG or TIFF files.
 Select [Fit to Paper Size], [Image Resolution] or [Fit to Print Resolution].

Item	Description
Fit to Paper Size	Fits the image size to the selected paper size.
Image Resolution	Prints at resolution of the actual image.
Fit to Print Resolution	Fits the image size to the print resolution.

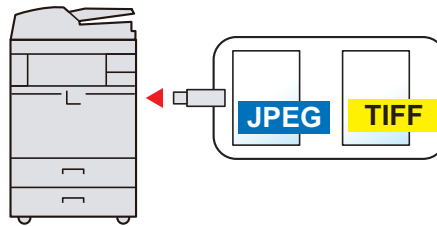

XPS Fit to Page



Reduces or enlarges the image size to fit to the selected paper size when printing XPS file.

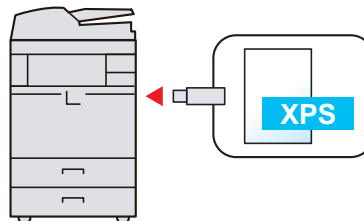

Functions Available in the Home Screen

Send to Me (E-mail)

When user login is enabled, the document is sent to the E-mail address of the logged in user.

 **NOTE**

- To use this function, the function icon must be displayed in the home screen.

 [Editing the Home Screen \(page 3-5\)](#)

- An E-mail address must be set in user login for the user who logs in.

 [Adding a User \(Local User List\) \(page 9-8\)](#)

Send to Me from Box (E-mail)

When user login is enabled, documents in the custom box are sent to the E-mail address of the logged in user.

 **NOTE**

- To use this function, the function icon must be displayed in the home screen.

 [Editing the Home Screen \(page 3-5\)](#)

- An E-mail address must be set in user login for the user who logs in.

 [Adding a User \(Local User List\) \(page 9-8\)](#)

- When this function is used, functions other than transmission cannot be used.

7 Status/Job Cancel

This chapter explains the following topics:

Checking Job Status	7-2
Details of the Status Screens	7-4
Checking Detailed Information of Jobs	7-9
Checking Job History	7-11
Checking the Detailed Information of Histories	7-13
Sending the Log History	7-13
Pause and Resumption of Jobs	7-14
Canceling of Jobs	7-14
Priority Override for Waiting Jobs	7-15
Reordering Print Jobs	7-16
Device/Communication	7-17
Checking the Remaining Amount of Toner and Paper (Paper/Supplies)	7-18

Checking Job Status

Check the status of jobs being processed or waiting to be printed.

Available Status Screens

The processing and waiting statuses of jobs are displayed as a list on the touch panel in four different screens - Printing Jobs, Sending Jobs, Storing Jobs, and Scheduled Jobs.

The following job statuses are available.

Status Display	Job status to be displayed
Print Job Status	<ul style="list-style-type: none"> • Copy • Printer • FAX reception • i-FAX reception • E-mail reception • Printing from Document Box • Printing data from removable memory • Application • Job Report/List
Send Job Status	<ul style="list-style-type: none"> • FAX transmission • i-FAX transmission • E-mail • Folder transmission • Application • Multiple destination • Sending Job FAX using Delayed transmission
Store Job Status	<ul style="list-style-type: none"> • Scan • FAX • i-FAX • Printer • Join Box Document • Copy Box Document
Scheduled Job	<ul style="list-style-type: none"> • Sending Job FAX using Delayed transmission

Displaying Status Screens

1 Display the screen.

Press the [**Status/Job Cancel**] key.

Status/
Job Cancel



2 Press the tab of the job you want to check.

To check the scheduled transmission job, press [Sending Jobs] and then [Scheduled Job].

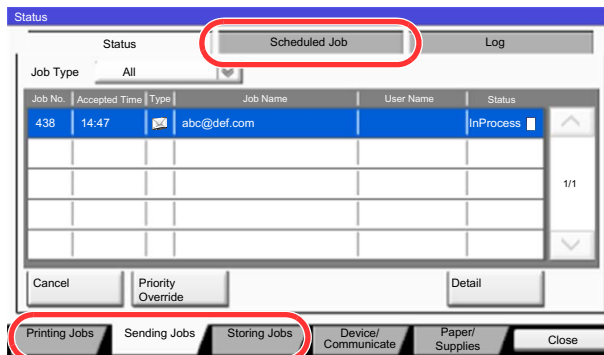

[Print Job Status Screen \(page 7-4\)](#)

[Send Job Status screen \(page 7-6\)](#)

[Store Job Status screen \(page 7-7\)](#)

[Scheduled Job Status Screen \(page 7-8\)](#)











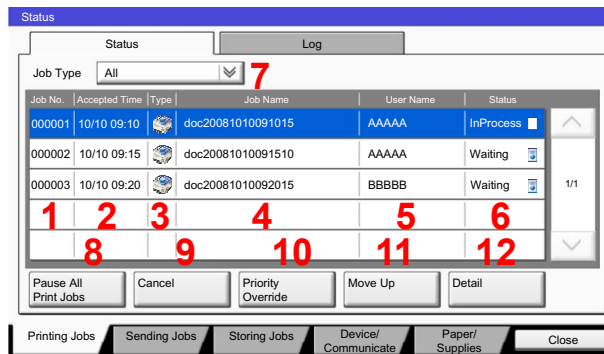

Details of the Status Screens

 **NOTE**

You can show the job statuses of all users, or only the statuses of your own jobs. For details, refer to [Display Status/Log on page 8-25](#). This setting can also be changed from Command Center RX. For details, refer to the **Command Center RX User Guide**.

Print Job Status Screen



No.	Item	Description
1	Job No.	Acceptance No. of job
2	Accepted Time	Accepted Time of job
3	Type	Icons that indicate the job type  Copy job  Printer job  Job from Document Box  FAX reception  i-FAX reception  E-mail reception  Data from removable memory  Application  Report/List
4	Job Name	Job Name or file name
5	User Name	User Name for the executed job
6	Status	Status of job InProcess: The status before starting to print. Printing: Printing Waiting: Print Waiting Pause: Pausing print job or error Canceling: Canceling the job
7	[∨] of "Job Type"	Only selected type of jobs is displayed.

No.	Item	Description
8	[Pause All Print Jobs]	Pauses all the printing jobs. By pressing this key again, the printing jobs will be resumed.
9	[Cancel]	Select the job you want to cancel from the list, and press this key.
10	[Priority Override]	Select the job to be overridden, and press this key. (Refer to Priority Override for Waiting Jobs on page 7-15.)
11	[Move Up]	In the list, select the job that you want to move up the job queue and press this key. (Refer to Reordering Print Jobs on page 7-16.)
12	[Detail]*	Select the job whose detailed information you want to display from the list, and press this key. (Refer to Checking Detailed Information of Jobs on page 7-9.) You can press [Change] in "Copies" in the detailed information screen to change the number of copies that are printed.





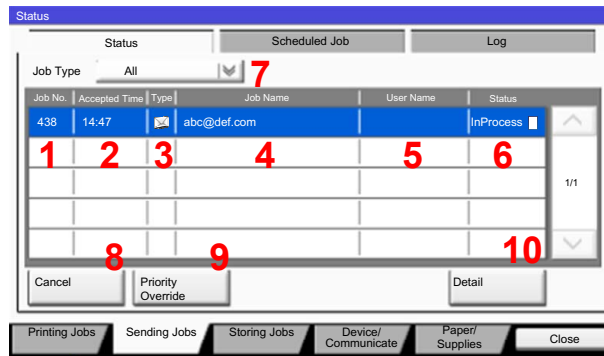

* This item is displayed when user login administration is enabled and the user has logged in as administrator.

**NOTE**

The job name and user name can be changed to other information if needed. For details, refer to [Customize Status Display on page 8-26](#). This setting can also be changed from Command Center RX. For details, refer to the **Command Center RX User Guide**.

Send Job Status screen



No.	Item	Description
1	Job No.	Acceptance No. of job
2	Accepted Time	Accepted Time of job
3	Type	Icons that indicate the job type  Sending Job FAX  Sending Job i-FAX  Sending Job E-mail  Sending Job Folder  Sending Job Application  Multi Sending
4	Destination	Destination (Either destination name, FAX number, E-mail address, or server name)
5	User Name	User Name for the executed job
6	Status	Status of job InProcess: The status before starting sending such as during scanning originals Sending: Sending Waiting: Waiting Sending Canceling: Canceling the job Pause: Pausing the job
7	[] of "Job Type"	Only selected type of jobs is displayed.
8	[Cancel]	Select the job you want to cancel from the list, and press this key.
9	[Priority Override]	Select the job to be overridden, and press this key.* Only displayed when the optional FAX Kit is installed.
10	[Detail]*	Select the job whose detailed information you want to display from the list, and press this key. (Refer to Checking Detailed Information of Jobs on page 7-9.)





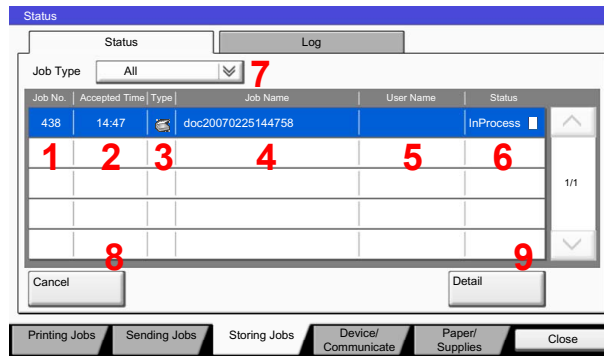

* This item is displayed when user login administration is enabled and the user has logged in as administrator.

NOTE

The address and user name can be changed to other information if needed. For details, refer to [Customize Status Display on page 8-26](#). This setting can also be changed from Command Center RX. For details, refer to the **Command Center RX User Guide**.

Store Job Status screen



No.	Item	Description
1	Job No.	Acceptance No. of job
2	Accepted Time	Accepted Time of job
3	Type	Icons that indicate the job type  Storing Job Scan  Storing Job Printer  Storing Job FAX  Storing Job i-FAX  Join Box Document  Copy Box Document
4	Job Name	Job name or file name is displayed.
5	User Name	User Name for the executed job
6	Status	Status of job InProcess: The status before starting to save such as during scanning originals Storing: Storing Data Canceling: Canceling the job Pause: Pausing the job
7	[∨] of "Job Type"	Only selected type of jobs is displayed.
8	[Cancel]	Select the job you want to cancel from the list, and press this key.
9	[Detail]*	Select the job whose detailed information you want to display from the list, and press this key. (Refer to Checking Detailed Information of Jobs on page 7-9.)

* This item is displayed when user login administration is enabled and the user has logged in as administrator.

NOTE

The job name and user name can be changed to other information if needed. For details, refer to [Customize Status Display on page 8-26](#). This setting can also be changed from Command Center RX. For details, refer to the **Command Center RX User Guide**.

Scheduled Job Status Screen

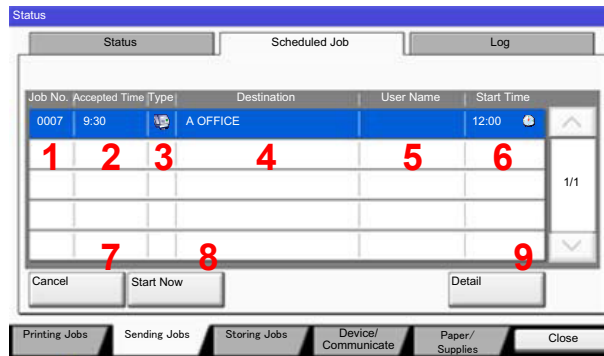

No.	Item	Description
1	Job No.	Acceptance No. of job
2	Accepted Time	Accepted Time of job
3	Type	Icons that indicate the job type  Storing Job FAX
4	Destination	Destination (Either destination name, FAX number, or No. of broadcast items)
5	User Name	User Name for the executed job
6	Start Time	Time to start the scheduled job
7	[Cancel]	Select the job you want to cancel from the list, and press this key.
8	[Start Now]	Select the job you want to send immediately from the list, and press this key.
9	[Detail]*	Select the job whose detailed information you want to display from the list, and press this key. (Refer to Checking Detailed Information of Jobs on page 7-9.)

* This item is displayed when user login administration is enabled and the user has logged in as administrator.

Checking Detailed Information of Jobs

Check the detailed information of each job.

 **NOTE**

This is displayed when user login administration is enabled and the user has logged in as administrator.

1 Display the screen.

Referring to [Details of the Status Screens on page 7-4](#), display the screen.

2 Check the information.

1 Select the job whose details you wish to check from the list, and press [Detail].

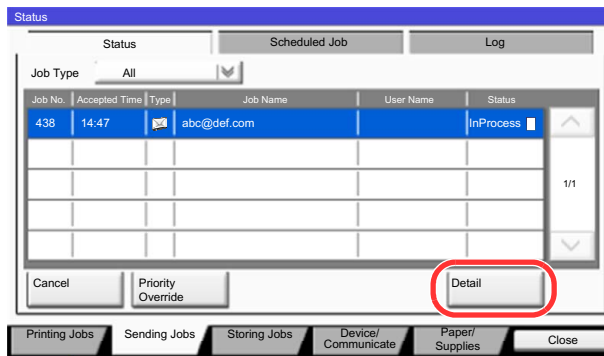

Detailed information of the selected job is displayed.

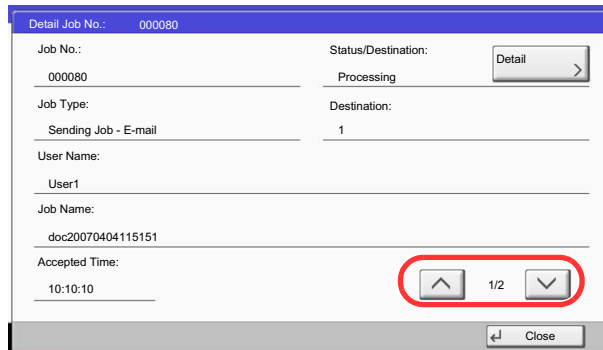

Use [∨] or [∧] to see the next or previous page of information.

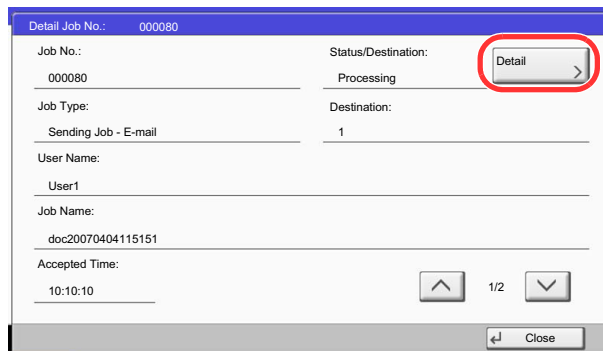

In Sending Jobs, you can check the destination by pressing [Detail] in "Destination" or "Status/Destination".

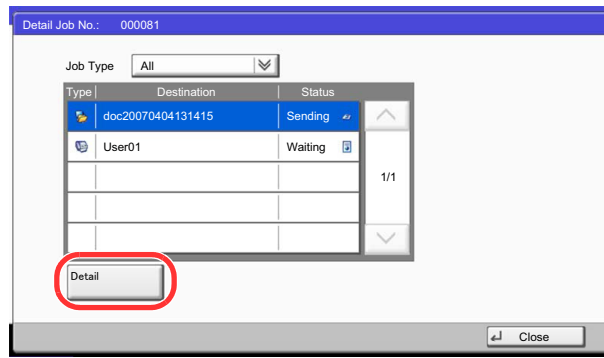

"Status/Destination" is displayed when address is selected. Press [Detail] to display the list. Press [▽] or [△], select a destination and press [Detail]. Information on the selected job is displayed for checking.

- 2 To exit from the detailed information, press [Close].

Checking Job History

Check the history of completed jobs.



NOTE

Job history is also available by Command Center RX or KYOCERA Net Viewer from the computer.

You can show the job log of all users, or only your own job log. For details, refer to [Display Status/Log on page 8-25](#). This setting can also be changed from Command Center RX. For details, refer to the **Command Center RX User Guide**.

Available Job History Screens

The job histories are displayed separately in three screens - Printing Jobs, Sending Jobs, and Storing Jobs. The following job histories are available.

Screen	Job histories to be displayed
Print Job Log	<ul style="list-style-type: none"> • Copy • Printer • FAX reception • i-FAX reception • E-mail reception • Printing from Document Box • Job Report/List • Printing data from removable memory
Send Job Log	<ul style="list-style-type: none"> • FAX • i-FAX • E-mail • Folder • Application • Multiple destination
Store Job Log	<ul style="list-style-type: none"> • Scan • FAX • i-FAX • Printer • Join Box Document • Copy Box Document

Displaying Job History Screen

1 Display the screen.

Press the [Status/Job Cancel] key.

Status/
Job Cancel



2 Press the tab of the job you want to check, and press the [Log] tab.

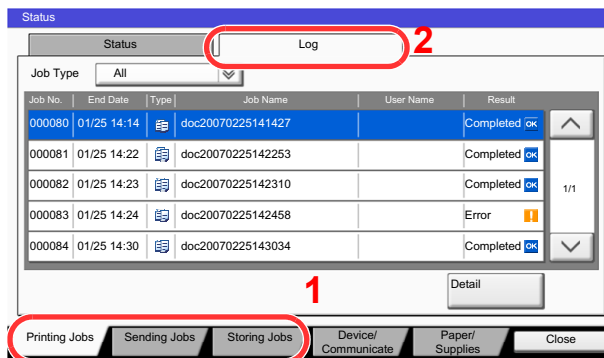

NOTE

If the user authentication screen appears, enter your login user name and login password and press [Login]. For this, you need to login with administrator privileges. The factory default login user name and login password are set as shown below.

Model Name	Login User Name	Login Password
3501i	3500	3500
4501i	4500	4500
5501i	5500	5500

Checking the Detailed Information of Histories

Check the detailed information of each history.

1 Display the screen.

Referring to [Displaying Job History Screen on page 7-12](#), display the screen.

2 Check the information.

- 1 Select the job to check details from the list, and press [Detail].

Detailed information of the selected job is displayed.

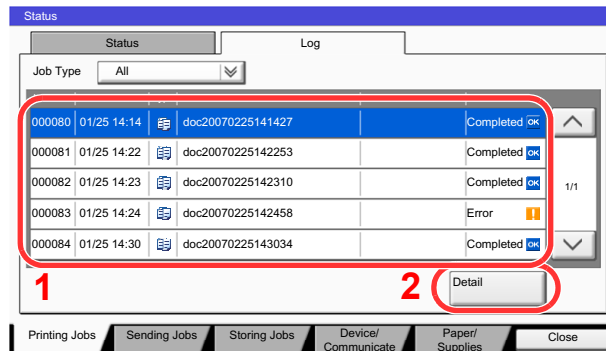

NOTE

To check the information of the next/previous page, press [V] or [^].

- 2 To exit from the detailed information, press [Close].

Sending the Log History

You can send the log history by E-mail. You can either send it manually as needed or have it sent automatically whenever a set number of jobs is reached. For details, refer to [Sending Log History on page 8-39](#).

Pause and Resumption of Jobs

Pause/resume all printing jobs in printing/waiting.

1 Display the screen.

Press the [Status/Job Cancel] key.

Status/
Job Cancel



2 Press [Pause All Print Jobs] on the printing jobs status screen.

Printing is paused.

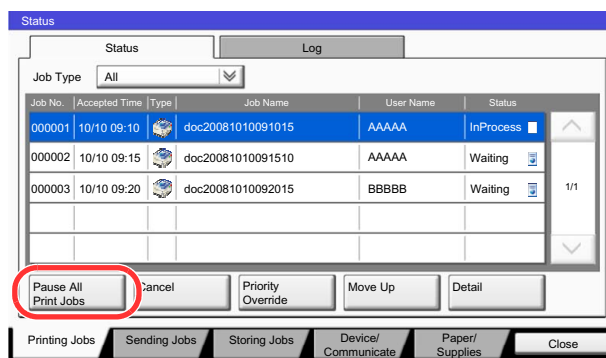

When resuming the printing of jobs that have been paused, press [Resume All Print Jobs].

Canceling of Jobs

A job in printing/waiting status can be canceled.

1 Display the screen.

Press the [Status/Job Cancel] key.

Status/
Job Cancel



2 Select the job to be canceled from the list, and press [Cancel].

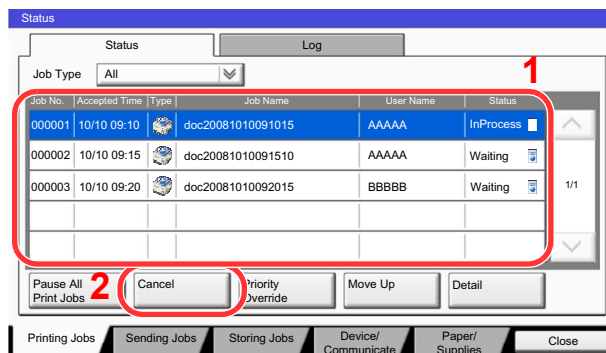

3 Press [Yes] in the confirmation screen.

Priority Override for Waiting Jobs

Priority Override function suspends the current job and prints the job in waiting first.

1 Display the screen.

Press the [Status/Job Cancel] key.

Status/
Job Cancel



2 Press [Printing Jobs].

3 Select the job to be given priority, and press [Priority Override].

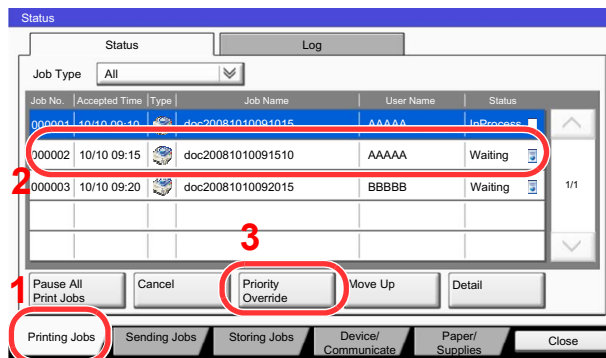

4 Press [Yes] in the confirmation screen.

The current job in printing is suspended, and the job for override printing starts.

When the Priority Override is completed, the printing job that has been suspended will be resumed.

Reordering Print Jobs

This function allows you to select a queued print job and raise its output priority.

1 Display the screen.

Press the [Status/Job Cancel] key.

Status/
Job Cancel



2 Press [Printing Jobs].

3 Select the job to be assigned a higher priority and press [Move Up].

The priority of the selected job is increased by 1.

To further raise the job's priority, press [Move Up] again. Each time you press [Move Up], the priority increases by 1.

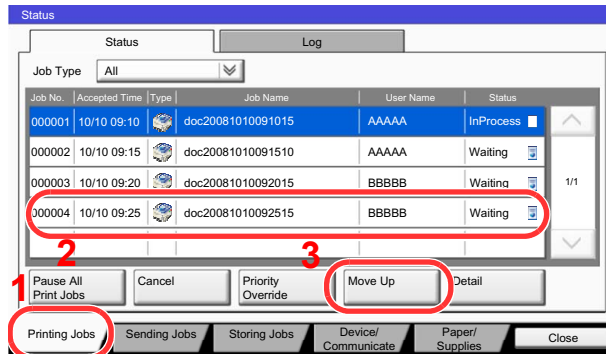

Device/Communication

Configure the devices/lines installed or connected to this machine or check their status.

1 Display the screen.

- 1 Press the **[Status/Job Cancel]** key.



- 2 Press **[Device/Communicate]**.

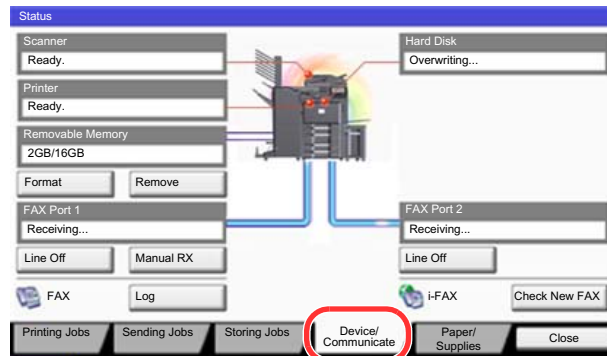

The screen to check the status or configure the devices is displayed.

2 Check the status.

The items you can check are described below.

"Scanner"

The status of an original scanning or the error information (paper jam, opened cover, etc.) is displayed.

"Printer"

Error information such as paper jam, out of toner, or out of paper, and status such as waiting or printing are displayed.

"Hard Disk"

The information such as formatting, overwriting for erasure, and error occurrence is displayed.

"Removable Memory (USB Memory)"

- The usage and capacity of the external media connected to this machine are displayed.
- Press **[Format]** to format external media.

✔ IMPORTANT

When **[Format] is pressed, all data in the external media is erased.**

- Press **[Remove]** to safely remove the external media.

"FAX Port 1", "FAX Port 2", "i-FAX"

For details on each item, refer to the **FAX Operation Guide**.

Checking the Remaining Amount of Toner and Paper (Paper/Supplies)

Check the remaining amount of toner, paper, and staples on the touch panel.

1 Display the screen.

- 1 Press the [Status/Job Cancel] key.



- 2 Press [Paper/Supplies].

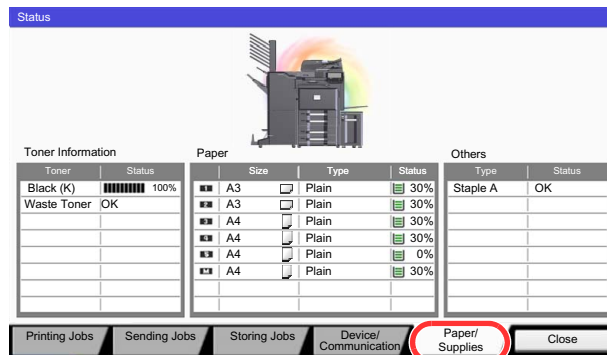

2 Check the status.

Check the remaining amount of toner and the status of the waste toner box in "Toner Information", and the remaining amount of paper in each paper source in "Paper".

The items you can check are described below.

"Toner Information"

Remaining amount of toner

You can check the remaining amount of toner level from 100 to 0% (1% increments).

Status of the waste toner box

You can check the status of waste toner box.

"Paper"

You can check the size, orientation, type, and remaining amount of paper in each paper source. The remaining amount of paper is shown by 5 levels as 100, 80, 50, 30, and 0%, however, the paper in the multi purpose tray is shown by 2 levels as 100% and 0%.

If the remaining amount of paper cannot be detected, "----" appears.

"Others"

You can check the status of staples and punch waste box.



NOTE

If the optional document finisher (1,000-Sheet Finisher or 4,000-Sheet Finisher) and punch unit are installed, the "Others" section provides the status of the punch waste box and whether or not staples are available.

8 Setup and Registration (System Menu)

This chapter explains the following topics:

System Menu	8-2
Operation Method	8-2
System Menu Settings	8-4
Cassette/MP Tray Settings	8-7
Common Settings	8-9
Home	8-28
Copy	8-28
Send	8-29
Document Box/Removable Memory	8-34
FAX	8-35
Printer	8-35
Report	8-37
System/Network	8-43
Edit Destination	8-53
User Login/Job Accounting	8-53
User Property	8-54
Date/Timer/Energy Saver	8-54
Adjustment/Maintenance	8-57
Internet	8-60
Application	8-60

System Menu

Configure settings related to overall machine operation.

Operation Method

System Menu is operated as follows:

1 Display the screen.

Press the [System Menu] key.

System Menu



2 Select a function.

Displays the System Menu items.

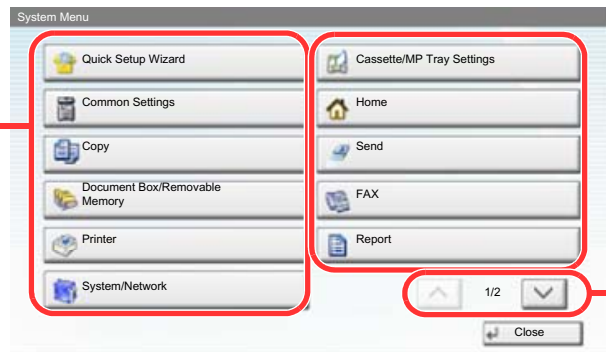

Scrolls up and down when the list of values cannot be displayed in its entirety on a single screen.

Displays setting items
Press the key of a function to display the setting screen.

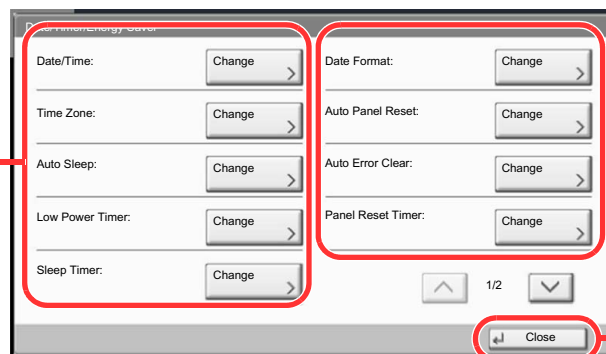

Returns to the previous screen.

3 Configure the settings.

Enter a setting by selecting it.

Returns to the previous screen without making any changes.

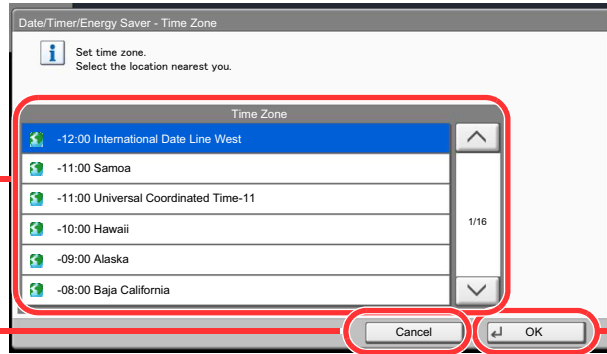

Accepts the settings and exits.



NOTE

In order to change settings that require administrator privileges, you must log in with administrator privileges.

The factory default login user name and login password are set as shown below.

Model Name	Login User Name	Login Password
3501i	3500	3500
4501i	4500	4500
5501i	5500	5500

Refer to **System Menu Settings** on the following page and configure as needed.

System Menu Settings

This section explains the functions that can be configured in System Menu. To configure the settings, select the item in System Menu and press the setting item. For details on each function, see the table below.

Item	Description	Reference Page
Quick Setup Wizard	The Quick Setup Wizard configures Fax and Energy Saver settings.	page 2-28
Cassette/MP Tray Settings	Select paper size and media type for Cassettes and multi purpose tray.	page 8-7
Cassette 1 (to 5)	Select type of paper in Cassette 1 (to 5).	page 8-7
MP Tray Setting	Select type of paper in multi purpose tray.	page 8-8
Common Settings	Configure overall machine operation.	page 8-9
Language	Select the language displayed on the touch panel.	page 8-9
Default Screen	Select the screen appearing right after start-up (default screen).	page 8-9
Sound	Set options for buzzer sound during the machine operations.	page 8-9
Original/Paper Settings	Configure settings for originals and paper.	page 8-10
Measurement	Select inch or metric for the unit for paper dimensions.	page 8-14
Error Handling	Select whether to cancel or continue the job when error has occurred.	page 8-14
Paper Output	Select output tray respectively for copy jobs, print jobs from Document Box, computers, and FAX RX data.	page 8-16
Orientation Confirmation	Check the orientation of original.	page 8-16
Function Defaults	<p>Defaults are the values automatically set after the warm-up is completed or the [Reset] key is pressed.</p> <p>Set the defaults for available settings such as copying and sending. Setting the frequently-used values as defaults makes subsequent jobs easier.</p> <p> IMPORTANT</p> <p>If you want to enable the changed defaults immediately, move to the function screen and press the [Reset] key.</p>	page 8-17
Keyboard Layout	Change the layout of the touch panel keyboard used to enter characters.	page 8-20
System Stamp	Configure settings for header, footer, and stamp.	page 8-20
Manual Staple	Configure settings for manual staple.	page 8-24
Offset Documents by Job	Select whether to offset documents by Job.	page 8-24
Low Toner Alert Level	Set the amount of remaining toner to alert low toner.	page 8-24
Offset One Page Documents	Set whether one-page documents are sorted.	page 8-25
Display Status/Log	Set the display method of the Status/Log.	page 8-25
Message Banner Print	Select whether the confirmation screen appears before each sheet is printed when printing multiple banner sheets.	page 8-25
Customize Status Display	Select the item that appears for the printing jobs status.	page 8-26
Function Key Usage	Configure settings for function key on the touch panel.	page 8-26
Message Board Settings	Configure settings for message board.	page 8-27
Remote Printing	Configure settings for remote printing.	page 8-27
Home	Configure settings for Home screen.	page 3-4
Copy	Configure settings for copying functions.	page 8-28

Item	Description	Reference Page
Send	Configure settings for sending functions.	page 8-29
Document Box/Removable Memory	Configure settings related to the Custom Box, Job Box, FAX Box, and Polling Box. For details on FAX Box and Polling Box, refer to the FAX Operation Guide .	page 8-34
FAX	Configure settings for fax functions. For details, refer to the FAX Operation Guide .	—
Printer	When printing from computers, settings are generally made on the application software screen. However, the following settings are available for configuring the defaults to customize the machine.	page 8-35
Report	Print reports to check the machine settings, status, and history. Settings for printing reports can also be configured.	page 8-37
Print Report	Configure settings for printing reports and histories.	page 8-37
Admin Report Settings		Refer to the FAX Operation Guide .
Result Report Settings		page 8-38
Sending Log History		page 8-39
Login History Settings		page 8-40
Device Log History Settings		page 8-41
Secure Comm. Error Log		page 8-42
System/Network	Configure machine system settings.	page 8-43
Network	Configure network settings.	page 8-43
Optional Network	Configure settings for the optional Network Interface Kit or Wireless Interface Kit.	page 8-47
Network Interface (Send)	Specify the network interface card to be used for send function and connecting to external address book.	page 8-49
Security Level	The Security Level setting is primarily a menu option used by service personnel for maintenance work. There is no need for customers to use this menu.	—
Interface Block Setting	This allows you to protect this machine by blocking the interface with external devices such as USB hosts or optional interfaces.	page 8-50
Data Security	Configure settings for data stored in the machine's hard disk and memory.	page 8-50
Document Guard	When the optional Printed Document Guard Kit is installed, careless copying and sending of documents that contain confidential or personal information is prevented.	page 8-51
Optional Function	You can activate the optional applications installed on this machine.	page 8-52
Restart Entire Device	Restart the CPU without turning the main power switch off. Use this to deal with any unstable operation by the machine. (Same as the computer restart.)	page 8-52
Edit Destination	Configure settings for Address Book and One Touch Key. For details on Address Book, refer to Registering Destinations in the Address Book on page 3-46 , and for details on One Touch Key, refer to Adding a Destination on One Touch Key (One Touch Key) on page 3-54 .	page 8-53

Item	Description	Reference Page
User Login/Job Accounting	Configure settings related to machine management. For details on User Login, refer to User Login on page 9-4 , and for details on Job Accounting, refer to Job Accounting on page 9-29 .	—
User Property	Check and change information related to the logged in user.	page 8-54
Date/Timer/Energy Saver	Configure settings related to the date, time, and energy saving.	page 8-54
Adjustment/Maintenance	Adjust printing quality and conduct machine maintenance.	page 8-57
Internet	Configure Internet settings for applications.	page 8-60
Application	Configure settings for the optional applications installed on this machine.	page 8-60

Cassette/MP Tray Settings

Select paper size and media type for Cassettes and multi purpose tray.

Cassette1 (to 5)

System Menu



▶ Cassette/MP Tray Settings

If a fixed size of paper will be used, set the paper size.

Selection Item		Selectable Size/Type
Paper Size	Auto	Paper size is automatically detected and selected. Value: Metric, Inch
	Standard Sizes 1 ^{*1}	Available options are as follows: Value Metric models: A3, A4-R, A4, A5-R, B4, B5-R, B5, Folio, 216 x 340 mm Inch models: Ledger, Letter-R, Letter, Legal, Statement, 12 x 18", Oficio II
	Standard Sizes 2 ^{*1}	Select from standard sizes except Standard Sizes 1. Value Metric models: Ledger, Letter-R, Letter, Legal, Statement, 12 x 18", Oficio II, 8K, 16K-R, 16K Inch models: A3, A4-R, A4, A5-R, B4, B5-R, B5, Folio, 216 x 340 mm, 8K, 16K-R, 16K
	Size Entry ^{*2}	Enter a size not displayed in the standard sizes. Value Metric X : 182 to 457 mm (in 1 mm increments) Y : 140 to 304 mm (in 1 mm increments) Inch X : 7.17 to 18.00" (in 0.01" increments) Y : 5.51 to 12.00" (in 0.01" increments)
Media type		Select the media type. Plain (60 to 105 g/m²), Rough, Vellum, Recycled, Preprinted^{*3}, Bond^{*4}, Color, Prepunched^{*3}, Letterhead^{*3}, Thick (106 g/m² and more)^{*4}, High Quality and Custom 1-8^{*1}

*1 Only A4, Letter, and B5 can be specified when the optional Large Capacity Feeder (1,500-sheet x 2) is used.

*2 Can be set when cassette 1 or cassette 2 is selected.

*3 To print on preprinted or prepunched paper or on letterhead, refer to [Special Paper Action on page 8-12](#).

*4 To change to a media type other than Plain, refer to [Media Type Setting on page 8-10](#). When the paper weight settings shown below are selected, the media indicated for each setting cannot be selected.

Rough: "Heavy 4" or "Heavy 5"

Preprinted: "Heavy 4" or "Heavy 5"

Letterhead: "Heavy 4" or "Heavy 5"

Thick: "Heavy 4" or "Heavy 5"

Bond: "Heavy 4"

Custom 1 to 8: "Heavy 4", "Heavy 5" or "Extra Heavy"

MP Tray Setting

System Menu



Cassette/MP Tray Settings

To fix the type of paper to be used in the multi purpose tray, specify the paper size.

Item		Description
Paper Size	Auto	Paper size is automatically detected and selected. Value: Metric, Inch
	Standard Sizes 1	Available options are as follows: Value Metric models: A3, A4-R, A4, A5-R, A6-R, B4-R, B5-R, B5, B6-R, Folio, 216 x 340 mm Inch models: Ledger, Letter-R, Letter, Legal, Statement, Executive, 12 x 18", Oficio II
	Standard Sizes 2	Select from standard size ^{*1} except Standard Sizes 1. Value Metric models: Ledger, Letter-R, Letter, Legal, Statement, Executive, 12 x 18", Oficio II, 8K, 16K-R, 16K Inch models: A3, A4-R, A4, A5-R, A6-R, B4-R, B5-R, B5, B6-R, Folio, 8K, 16K-R, 16K, 216 x 340 mm
	Others	Select from non-standard sizes and custom sizes. Value: ISO B5, Envelope #10 (Commercial #10), Envelope #9 (Commercial #9), Envelope #6 (Commercial #6 3/4), Envelope Monarch, Envelope DL, Envelope C5, Envelope C4, Hagaki, Oufuku hagaki, Youkei 4, Youkei 2
	Size Entry	Enter the size not included in the standard size. Value Metric X: 148 to 457 mm (in 1 mm increments) Y: 98 to 304 mm (in 1 mm increments) Inch X: 5.83 to 18.00" (in 0.01" increments) Y: 3.86 to 12.00" (in 0.01" increments)
Media type		Select the media type. Value: Plain (60 to 105 g/m ²), Transparency, Rough, Vellum, Labels, Recycled, Preprint ^{*2} , Bond, Cardstock, Color, Prepunched ^{*2} , Letterhead ^{*2} , Envelope, Thick (106 g/m ² and more), Coated, High Quality, Index Tab Dividers, Custom 1-8

*1 To change to a media type other than "Plain", refer to [Media Type Setting on page 8-10](#).

*2 To print on preprinted or prepunched paper or on letterhead, refer to [Special Paper Action on page 8-12](#).



NOTE

If the optional FAX Kit is installed, the available media types for printing received faxes are as shown below.

Plain, Rough, Vellum, Labels, Recycled, Bond, Cardstock, Color, Envelope, Thick, Coated, High Quality and Custom 1-8

Common Settings

Configure overall machine operation.

Language

System Menu  **Common Settings**

Item	Description
Language	Select the language displayed on the touch panel.

Default Screen

System Menu  **Common Settings**

Item	Description
Default screen	<p>Select the screen appearing right after start-up (default screen).</p> <p>Value: Home, Copy, Send, FAX*¹, Status, Custom Box, Job Box, Removable Memory, FAX Box*¹, Program, Home (Accessibility), Accessibility Copy, Accessibility Send, Accessibility FAX*¹, Internet Browser*², Application Name*³</p> <p> NOTE</p> <p>If a screen other than [Home] is set, [Power Saving Recovery] in [EnergySaver RecoveryLevel] will not operate if selected.</p>

*1 Displayed only when the optional FAX Kit is installed.

*2 Referring to [Internet on page 8-60](#) and configure necessary settings for Internet Browser.

*3 The running application will be displayed. For details, refer to [Application on page 5-10](#).

Sound

System Menu  **Common Settings**

Item	Description
Buzzer	Set options for buzzer sound during the machine operations.
Volume	Set the buzzer volume level. Value: 0 (Mute), 1 (Minimum), 2, 3 (Medium), 4, 5 (Maximum)
Key Confirmation	Emit a sound when the operation panel and touch panel keys are pressed. Value: Off, On
Job Finish	Emit a sound when a print job is normally completed. Value: Off, On, FAX Reception Only*
Ready	Emit a sound when the warm-up is completed. Value: Off, On
Warning	Emit a sound when errors occur. Value: Off, On
USB Keyboard	Emit a sound to confirm keypresses with a sound. Value: Off, On
FAX Speaker Volume*	For details, refer to the FAX Operation Guide .
FAX Monitor Volume*	For details, refer to the FAX Operation Guide .

* Displayed only when the optional FAX Kit is installed.

Keyboard Layout

Item	Description
Keyboard Layout	Set the layout of the keyboard. Value: QWERTY, QWERTZ, AZERTY

Original/Paper Settings









System Menu

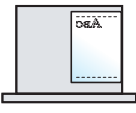
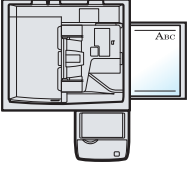

▶ Common Settings

Item	Description
Custom Original Size	<p>Set up frequently-used custom original size.</p> <p>To register a custom paper size, press [On] and enter the desired size. The custom size options are displayed on the screen to select original size. Up to four custom original sizes can be added.*</p> <p>Value</p> <p>Custom 1 to 4: Off, On</p> <p>Size Entry:</p> <p>Metric</p> <p>X: 50 to 432 mm (in 1 mm increments)</p> <p>Y: 50 to 297 mm (in 1 mm increments)</p> <p>Inch</p> <p>X: 2.00 to 17.00" (in 0.01" increments)</p> <p>Y: 2.00 to 11.69" (in 0.01" increments)</p>
Custom Paper Size	<p>Set up a maximum of four frequently-used custom paper sizes.</p> <p>To register a custom paper size, press [On] and enter the desired size. The custom size option is displayed on the screen to select paper set in the multi purpose tray. Up to four custom paper sizes can be added.</p> <p>Select media type for each paper size. Select [Media Type], and select paper type.*</p> <p>Value</p> <p>Custom 1 to 4: Off, On</p> <p>Size Entry:</p> <p>Metric</p> <p>X: 148 to 457 mm (in 1 mm increments)</p> <p>Y: 98 to 304 mm (in 1 mm increments)</p> <p>Inch</p> <p>X: 5.83 to 18.00" (in 0.01" increments)</p> <p>Y: 3.86 to 12.00" (in 0.01" increments)</p> <p>Media Type: Plain, Transparency, Rough, Vellum, Labels, Recycled, Preprinted, Bond, Cardstock, Color, Prepunched, Letterhead, Thick, Envelope, Coated, High Quality, Index Tab Dividers, Custom 1-8</p>
Media Type Setting	<p>Set weight for each media type.</p> <p>For Custom 1-8, settings for duplex printing and media type name can be changed.</p> <p>For details on setting value, refer to Media Type Setting on page 8-13.</p>

Item	Description
Default Paper Source	Select paper cassette for default setting. Value: Cassette 1 to 5, Multi Purpose Tray  NOTE [Cassette 3] to [Cassette 5] are displayed when the following options are installed. [Cassette 3]: When a paper feeder (500-sheet x 2) or large capacity paper feeder (1,500-sheet x 2) is installed [Cassette 4]: When a paper feeder (500-sheet x 2) or large capacity paper feeder (1,500-sheet x 2) is installed [Cassette 5]: When a side feeder (3,000-sheet) is installed
Auto Switch	When the optional large capacity feeder is selected, the cassette can be switched to another large capacity feeder depending on your usage. Value: Off, On
Auto Detect Original Size (Available for metric models only)	Select whether to automatically detect originals of special or non-standard size.
A6/Hagaki	As A6 and Hagaki are similar in size, select either one of them for automatic detection. Value: A6, Hagaki
Folio	Select whether to enable automatic detection of Folio. Value: Off, On
11 × 15"	Select whether to enable automatic detection of 11×15" size. Value: Off, On
Media for Auto (B&W)	Select a default media type for auto paper selection when [Auto] is selected of Paper Selection. If [Plain] is selected, the paper source with plain paper loaded in the specific size is selected. Select [All Media Types] for the paper source with any kind of paper loaded in the specific size. Value: All Media Types, Plain, Transparency, Vellum, Rough, Labels, Recycled, Preprinted, Bond, Cardstock, Color, Prepunched, Letterhead, Envelope, Thick, Coated, High Quality, Index Tab Dividers, Custom 1-8

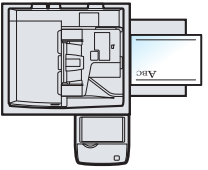
Item	Description
<p>Paper Source for Cover</p>	<p>Select the paper source in which the cover paper used for the Cover function is placed.* Value: Cassette 1 to 5, Multi Purpose Tray</p> <p> NOTE</p> <p>[Cassette 3] to [Cassette 5] are displayed when the following options are installed.</p> <p>[Cassette 3]: When a paper feeder (500-sheet x 2) or large capacity paper feeder (1,500-sheet x 2) is installed</p> <p>[Cassette 4]: When a paper feeder (500-sheet x 2) or large capacity paper feeder (1,500-sheet x 2) is installed</p> <p>[Cassette 5]: When a side feeder (3,000-sheet) is installed</p>
<p>Special Paper Action</p>	<p>When printing on Prepunched, Preprint, and Letterhead, punch-holes might not be aligned or the print direction might be upside-down depending on how originals are set and the combination of copying functions. In such a case, select [Adjust Print Direction] to adjust the print direction. When paper orientation is not important, select [Speed Priority].</p> <p>If [Adjust Print Direction] is selected, load paper according to the steps below.</p> <p>Example: copying on Letterhead</p> <div style="display: flex; justify-content: space-around; align-items: flex-start;"> <div style="text-align: center;">  Original </div> <div style="text-align: center;">  Paper </div> <div style="text-align: center;">  Finishing </div> <div style="text-align: center;">  Cassette </div> <div style="text-align: center;">  MP Tray </div> </div> <div style="display: flex; justify-content: space-around; align-items: flex-start; margin-top: 10px;"> <div style="text-align: center;">  Original </div> <div style="text-align: center;">  Paper </div> <div style="text-align: center;">  Finishing </div> <div style="text-align: center;">  Cassette </div> <div style="text-align: center;">  MP Tray </div> </div> <p>Value: Adjust Print Direction, Speed Priority</p>

* If you want to enable the changed defaults immediately, move to the function screen and press the [Reset] key.

Media Type Setting

The following settings can be selected. Y (default): Default setting, Y: Available, N: Not available

Paper Weight	Light ^{*1}	Normal 1 ^{*1}	Normal 2 ^{*1}	Normal 3 ^{*1}	Heavy 1 ^{*1}	Heavy 2	Heavy 3	Heavy 4	Heavy 5	Extra Heavy
Weight (g/m ²), Media Type	52 g/m ² to 59 g/m ²	60 g/m ² to 74 g/m ²	75 g/m ² to 90 g/m ²	91 g/m ² to 105 g/m ²	106 g/m ² to 135 g/m ²	136 g/m ² to 163 g/m ²	164 g/m ² to 220 g/m ²	221 g/m ² to 256 g/m ²	257 g/m ² to 300 g/m ²	Transpa rencies
Plain	N	Y	Y (default)	Y	N	N	N	N	N	N
Rough	N	Y	Y	Y (default)	Y	Y	Y	Y ^{*2}	Y ^{*2}	N
Vellum	N	Y	Y	Y	Y (default)	Y	Y	Y ^{*2}	Y ^{*2}	N
Labels	N	Y ^{*2}	Y ^{*2}	Y ^{*2}	Y ^{*2}	Y ^{*2} (default)	Y ^{*2}	Y ^{*2}	Y ^{*2}	N
Recycled	N	Y	Y (default)	Y	N	N	N	N	N	N
Preprinted	N	Y	Y (default)	Y	Y	Y	Y	Y ^{*2}	Y ^{*2}	N
Bond	N	Y	Y	Y (default)	Y	Y	Y	Y ^{*2}	N	N
Cardstock	N	N	N	N	Y ^{*2}	Y ^{*2}	Y ^{*2}	Y ^{*2} (default)	Y ^{*2}	N
Color	N	Y	Y	Y (default)	Y	Y	Y	Y ^{*2}	Y ^{*2}	N
Prepunched	N	Y	Y (default)	Y	N	N	N	N	N	N
Letterhead	N	Y	Y (default)	Y	Y	Y	Y	Y ^{*2}	Y ^{*2}	N
Envelope	N	N	N	N	Y ^{*2}	Y ^{*2} (default)	Y ^{*2}	Y ^{*2}	Y ^{*2}	N
Thick	N	N	N	N	Y	Y (default)	Y	Y ^{*2}	Y ^{*2}	N
Coated	N	Y ^{*2}	Y ^{*2}	Y ^{*2}	Y ^{*2} (default)	Y ^{*2}	Y ^{*2}	Y ^{*2}	Y ^{*2}	N
High Quality	N	Y	Y (default)	Y	Y	Y	N	N	N	N
Index Tab Dividers	N	N	N	N	N	Y ^{*2}	Y ^{*2}	Y ^{*2} (default)	N	N
Transparencies	N	N	N	N	N	N	N	N	N	Y (default)
Custom 1-8	Y	Y	Y (default)	Y	Y	Y	Y	Y ^{*2}	Y ^{*2}	Y

*1 The maximum number of sheets that can be stapled varies depending on the paper weight. For details, see [1,000-Sheet Finisher \(Option\) on page 11-28](#) and [4,000-Sheet Finisher \(Option\) on page 11-29](#).

*2 The media type cannot be selected for the cassettes.

For Custom 1-8, settings for duplex printing and media type name can be changed.

Item		Description
Duplex Print	Prohibit	Duplex printing not allowed.
	Permit	Duplex printing allowed.
Name		Change names for Custom 1-8. Names should be not more than 16 characters. Selecting media type at multi purpose tray, the name after change will be displayed.  Character Entry Method (page 11-10)



Measurement



System Menu  **Common Settings**

Item	Description
Measurement	Select inch or metric for the unit for paper dimensions. Value: mm, inch

Error Handling

System Menu  **Common Settings**

Item	Description
Duplexing Error	Set what to do when duplex printing is not possible for the selected paper sizes and media types. Value 1-sided: Printed in 1-sided Display Error: Message to cancel printing is displayed.
Finishing Error	Set alternative actions when finishing (Staple/Punch/Offset/Fold/Auto Image Rotation) is not available for the selected paper size or media type. Value Ignore: The setting is ignored and the job is printed. Display Error: Message to cancel printing is displayed.
No Staple Error	Set what to do when staples run out during printing. Value Ignore: Printing continues without stapling. Display Error: Message to cancel printing is displayed.  NOTE Requires the optional 1,000-Sheet Finisher or 4,000-Sheet Finisher.
Finished Pages Exceeded	Set what to do when finishing (stapling or offsetting) capacity is exceeded during printing. Value Ignore: Printing continues without finishing. Display Error: Message to cancel printing is displayed.  NOTE Requires the optional 1,000-Sheet Finisher or 4,000-Sheet Finisher.

Item	Description
Punch Waste Full Error	<p>Set what to do when the punch waste box becomes full during printing.</p> <p>Value</p> <p>Ignore: Printing continues without punching.</p> <p>Display Error: Message to cancel printing is displayed.</p> <p> NOTE</p> <p>Requires the optional 1,000-Sheet Finisher or 4,000-Sheet Finisher.</p>
Paper Mismatch Error	<p>Set what to do when the selected paper size or type does not match paper size or type loaded in the specified paper source while printing from the computer by specifying the cassette or multi-purpose tray.</p> <p>Value</p> <p>Ignore: The setting is ignored and the job is printed.</p> <p>Display Error: Message to cancel printing is displayed.</p>
Inserted Paper Mismatch	<p>Set what to do when it is detected that the cassette paper size setting does not match the actual paper size that is fed.</p> <p>Value</p> <p>Ignore: The setting is ignored and the job is printed.</p> <p>Display Error: Message to cancel printing is displayed.</p>
Paper Jam before Staple	<p>The page from which printing is resumed when a paper jam occurs during a job with stapling can be selected.</p> <p>Value</p> <p>Resume at Top of Page: Resume printing from the first page of the document.</p> <p>Resume at Jammed Page: Resume printing from the page where the jam occurred.</p> <p> NOTE</p> <p>Requires the optional 1,000-Sheet Finisher or 4,000-Sheet Finisher.</p>

Paper Output

System Menu  **Common Settings**

If you want to enable the changed defaults immediately, move to the function screen and press the [**Reset**] key.

Item	Description
<p>Paper Output</p>	<p>Select the output tray respectively for copy jobs, print jobs from Document Box, computers, and FAX RX data.</p> <p>Value: Inner Tray: Outputs to the Inner Tray of the machine. Can be selected when the optional 1,000-Sheet Finisher or 4,000-Sheet Finisher is not installed. Tray A, Tray B, Tray C: Delivery to Trays A to C of the optional 4,000-Sheet Finisher. Finisher Left Tray, Finisher Top Tray: Delivery to the Left Tray or Top Tray of the optional 1,000-Sheet Finisher. Right tray: Delivery to the optional Right Job Separator. Job Separator: Delivery to the optional Inner Job Separator. Can be selected when the optional 1,000-Sheet Finisher or 4,000-Sheet Finisher is not installed. Tray 1 to 7: Delivery to trays 1 to 7 (tray 1 is the uppermost tray) of the optional Mailbox.</p> <p> NOTE When [Heavy 3] (164 g/m² -) or higher is set in Paper Weight and Mailbox (Option) is set for the output destination, the output destination is automatically changed to a tray that can be used. FAX RX data output can be specified when the optional FAX Kit is installed.</p>

Orientation Confirmation

System Menu  **Common Settings**

Item	Description
<p>Orientation Confirmation</p>	<p>Select whether to display a screen for selecting the orientation of the originals to be placed on the platen when using the following functions.</p> <p>Refer to Original Orientation on page 6-15 for details.</p> <ul style="list-style-type: none"> • Zoom (XY Zoom) • Duplex • Margin/Centering • Border Erase • Combine • Memo Page • Page # • Booklet • Staple/Punch (optional feature) • 2-sided/Book Original • Text Stamp • Bates Stamp <p>Value: Off, On</p>

Function Defaults

System Menu













▶ Common Settings

If you want to enable the changed defaults immediately, move to the function screen and press the **[Reset]** key.

Item	Description
Original Orientation	Set the original orientation defaults. Value: Top Edge on Top, Top Edge on Left
Original Image (Copy)	Set the default original document type for copying. Value: Text+Photo (Printer), Text+Photo (Magazine), Photo (Printer), Photo (Magazine), Photo (Photo Paper), Text, Text (Fine Line), Graphic/Map (Printer), Graphic/Map (Magazine)
Org. Image (Send/Store)	Set the default original document type for sending/storing. Value: Text + Photo, Photo, Text, Text (for OCR)
Scan Resolution	Select the default scanning resolution. Value: 600×600dpi, 400×400dpi Ultra Fine, 300×300dpi, 200×400dpi Super Fine, 200×200dpi Fine, 200×100dpi Normal
FAX TX Resolution*	For details, refer to the FAX Operation Guide .
Color Selection	Select the default color mode for scanning documents. Value: Auto Color (Color/Gray), Auto Color (Color/B & W), Full Color, Grayscale, Black & White
File Format	Set the default type of the files. Value: PDF, TIFF, JPEG, XPS, High Comp. PDF
File Separation	Select the default file separation setting. Value: Off, Each Page
Backgrnd Density (Copy)	Set the default Backgrnd Density (Copy). Value: Off, Auto, Manual (Darker 5)
BackgrndDens.(Send/Store)	Set the default Backgrnd Density (Send/Store). Value: Off, Auto, Manual (Darker 5)
Prevent Bleed-thru (Copy)	Set the default value for preventing bleed-through (Copy). Value: Off, On
Prevent Bleed(Send/Store)	Set the default Prevent Bleed (Send/Store). Value: Off, On
Zoom	Select the enlarged/reduced default when paper size/sending size changed after the originals set. Value: 100%, Auto
Border Erase Default	Set the default width to be erased as a border. Value Metric: 0 to 50 mm (in 1 mm increments) Inch: 0 to 2" (in 0.01" increments)  NOTE To specify border erase widths around original, set the value in "Border". To specify border erase widths in the middle of original, set the value in "Gutter".
Border Erase to Back Page	Select the Border Erase Method for Back Page of a sheet. Value: Same as Front Page, Do Not Erase

Item	Description
Margin Default	Set the default margin. Value Metric Left/Right: -18 to 18 mm (in 1 mm increments) Top/Bottom: -18 to 18 mm (in 1 mm increments) Inch Left/Right: -0.75 to 0.75" (in 0.01" increments) Top/Bottom: -0.75 to 0.75" (in 0.01" increments)
Auto Image Rotation (Copy)	Select the default Auto Image Rotation setting. Value: Off, On
EcoPrint	Select the EcoPrint default. Value: Off, On
Toner Save Level (EcoPrint)	Select the default Toner Save Level (EcoPrint). Value: [1](Low) to [5](High)  NOTE Raising the level reduces toner consumption, but image quality falls.
High Comp. PDF Image	Select the default quality setting for high compressed PDF files. Value: Compression Ratio Priority, Standard, Quality Priority
Color TIFF Compression	Select the compression method for sending the color documents in the TIFF format. Value: [TIFF V6], [TTN2]
Image Quality (File Format)	Select the default PDF/TIFF/JPEG/XPS file quality. Value: 1 Low Quality (High Comp.) to 5 High Quality (Low Comp.)
Collate/Offset	Set the defaults for Collate/Offset. Value Collate: Off, On Offset: Off, Each Set (If [Off] is selected of Collate, it is set to [Each Page].)
JPEG/TIFF Print	Select the image size (resolution) when printing JPEG or TIFF file. Value: Fit to Paper Size, Image Resolution, Fit to Print Resolution
XPS Fit to Page	Set the default value for the XPS fit to page function. Value: Off, On
PDF/A	Select the default PDF/A setting. Value: Off, PDF/A-1a, PDF/A-1b
Cont. Scan (Except FAX)	Set the continuous scan defaults. Value: Off, On
Continuous Scan (FAX)*	For details, refer to the FAX Operation Guide .
File Name Entry	Set an automatically entered name (default) for jobs. Additional information such as Date and Time and Job No. can also be set. Value File Name: Up to 32 characters can be entered. Additional Info: None, Date and Time, Job No., Job No. & Date and Time, Date and Time & Job No.

Item	Description
E-mail Subject/Body	<p>Set the subject and body automatically entered (default subject and body) when sending the scanned originals by E-mail. Three body messages can be registered, and the initial template can be used to choose which body message is used.</p> <p>Value</p> <p>Subject: Up to 60 characters can be entered.</p> <p>Body 1 to 3: Up to 500 characters can be entered.</p>
i-FAX Subject/Body	<p>Set the subject and body automatically entered (default subject and body) when sending the scanned originals by i-FAX.</p> <p>Value</p> <p>Subject: Up to 60 characters can be entered.</p> <p>Body: Up to 500 characters can be entered.</p> <p> NOTE</p> <p>This function is displayed when the optional Internet FAX Kit is installed.</p> <p> Internet FAX Kit(A) "Internet FAX Kit" (page 11-7)</p>
DP Read Action	<p>Set the operation when a document is scanned from the document processor.</p> <p>Value: Speed Priority, Quality Priority</p> <p> NOTE</p> <p>This function is displayed when the optional document processor is installed.</p> <p>When Document Guard is set to [On], this function will not be displayed.</p>
OCR Text Recognition	<p>Set the default OCR Text Recognition.</p> <p>Value: Off, On</p> <p> NOTE</p> <p>This function can only be used when the optional OCR Scan Activation Kit is installed.</p> <p> Scan extension kit(A) "OCR Scan Activation Kit" (page 11-7)</p>
Primary OCR Language	<p>Set the default language of the text to be extracted. ([English] is selected as a default.)</p> <p>Select the language to extract from the options displayed on the touch panel.</p> <p> NOTE</p> <p>This function can only be used when the optional OCR Scan Activation Kit is installed.</p> <p> Scan extension kit(A) "OCR Scan Activation Kit" (page 11-7)</p>
Auto Image Rotation (OCR)	<p>Set the default Auto Image Rotation (OCR).</p> <p>Value: Off, On</p> <p> NOTE</p> <p>This function can only be used when the optional OCR Scan Activation Kit is installed.</p> <p> Scan extension kit(A) "OCR Scan Activation Kit" (page 11-7)</p> <p>If you frequently use the originals with the mixed orientation, select [On].</p>

Item	Description
Repeat Copy	Select the Repeat Copy default. Value: Off, On  NOTE This function will not be displayed when the optional Data Security Kit is installed. This function will not be displayed when Repeat Copy Job Retention is set to 0.
Skip Blank Page	Select the default Skip Blank Page settings. Value: Off, On

* Displayed only when the optional FAX Kit is installed.

USB Keyboard Type





System Menu  **Common Settings**





Item	Description
USB Keyboard Type	Set the type of USB keyboard that is connected. Value: US-English, US-English with Euro, French, German





System Stamp

System Menu  **Common Settings**

Item	Description
Basic	Configure settings for stamps.
Text (Text Stamp)	Press [Add/Edit] to edit the test string for a template. Up to 8 templates can be registered. Press [Delete] to delete a template.
Font (Page #)	Set the font size for page numbers when printing them. Value: 6.0 to 64.0 pt
Font (Bates Stamp)	When a bates stamp is used, set the font sizes that can be set. Value: 6.0 to 64.0 pt
Font (Text Stamp)	Set the font size for stamps when printing them. Value: 6.0 to 64.0 pt

Item	Description
Printing Jobs	Configure settings for stamps when a document is printed. After configuring the setting, return to the Copying Functions or Custom Box (Printing a Document) screen from System Menu, and press the [Reset] key.
Text Stamp	Select whether to print a text stamp on all printing jobs. Value: Off, On  NOTE When [On] is selected, the Text Stamp settings cannot be changed when printing.
Edit Text Stamp	Set the default text stamp.
Stamp	Select a text string to be stamped from templates, or press [Stamp] and enter a maximum of 32 characters for the text string.  NOTE Templates that have been set will appear. For details on registering templates, refer to Text (Text Stamp) on page 8-20 .
Stamp Method	Select the stamp method for the text stamp. Value: Each Print Page, Each Original Page
Position	Set the text stamp position. Value: Top Left, Top Middle, Top Right, Middle Left, Center, Middle Right, Bottom Left, Bottom Middle, Bottom Right, Detail  NOTE Press [Detail] to set the stamp position using numeric values, and to set the stamp position and angle when a stamp is placed on the back side of the paper in duplex printing.
Font	Set the font of the text stamp. Value Size: Font sizes registered in Font (Text Stamp) on page 8-20 are displayed. Character Border: Off, Circle, Rectangle, Underline Style: None, Bold, Italic, Bold/Italic Font: Courier, Letter Gothic Color: Black, White Density: 10 to 100% (in 10% increments) Display Pattern: Transparent, Clipping, Overwrite
Bates Stamp	Select whether to print a bates stamp on all printing jobs. Value: Off, On  NOTE When [On] is selected, the Bates Stamp settings cannot be changed when printing.
Edit Bates Stamp	Set the default Bates Stamp. Value: Date, User Name, Serial Number, Numbering, Text 1, Text 2, Date Format, Numbering Default, Position, Font  NOTE To set [Text 1] or [Text 2], press [Change] below and enter a maximum of 32 characters for the text string. To set [Date], press [Date Format] and set the date display format. To set [Numbering], press [Numbering Default] and set the starting sequence number (1 to 9999999). Press [Detail] in "Position" to set the stamp position using numeric values, and to set the stamp position to be placed on the back side of the paper in duplex printing.

Item	Description
Sending Jobs	Configure stamp settings for sending documents. After configuring the setting, return to the Sending Functions or Custom Box (Sending Documents) screen from System Menu, and press the [Reset] key.
Text Stamp	Select whether to print a text stamp on all sending jobs. Value: Off, On  NOTE When [On] is selected, the Text Stamp settings cannot be changed when sending.
Edit Text Stamp	Set the default text stamp.
Stamp	Select a text string to be stamped from templates, or press [Stamp] and enter a maximum of 32 characters for the text string.  NOTE Templates that have been set will appear. For details on registering templates, refer to Text (Text Stamp) on page 8-20 .
Position	Set the text stamp position. Value: Top Left, Top Middle, Top Right, Middle Left, Center, Middle Right, Bottom Left, Bottom Middle, Bottom Right, Detail  NOTE Press [Detail] to set the stamp position using numeric values, and to set the stamp angle.
Font	Set the font of the text stamp. Value Size: Font sizes registered in Font (Text Stamp) on page 8-20 are displayed. Character Border: Off, Circle, Rectangle, Underline Style: None, Bold, Italic, Bold/Italic Font: Courier, Letter Gothic Color: Black, Red, Green, Blue, Cyan, Magenta, Yellow, White Density: 10 to 100% (in 10% increments) Display Pattern: Transparent, Clipping, Overwrite
Bates Stamp	Select whether to print a bates stamp on all sending jobs. Value: Off, On  NOTE When [On] is selected, the Bates Stamp settings cannot be changed when sending.
Edit Bates Stamp	Set the default Bates Stamp. Value: Date, User Name, Serial Number, Numbering, Text 1, Text 2, Date Format, Numbering Default, Position, Font  NOTE To set [Text 1] or [Text 2], press [Change] below and enter a maximum of 32 characters for the text string. To set [Date], press [Date Format] and set the date display format. To set [Numbering], press [Numbering Default] and set the starting sequence number (1 to 9999999). When you press [Detail] in "Position", the stamp position can be specified using numeric values.

Item	Description
Storing Jobs	Configure stamp settings for storing documents in removable memory. After configuring the setting, return to the Custom Box (Storing Documents) screen from System Menu, and press the [Reset] key.
Text Stamp	Select whether to print a text stamp on all storing jobs. Value: Off, On  NOTE When [On] is selected, the Text Stamp settings cannot be changed when storing.
Edit Text Stamp	Set the default text stamp.
Stamp	Select a text string to be stamped from templates, or press [Stamp] and enter a maximum of 32 characters for the text string.  NOTE Templates that have been set will appear. For details on registering templates, refer to Text (Text Stamp) on page 8-20 .
Position	Set the text stamp position. Value: Top Left, Top Middle, Top Right, Middle Left, Center, Middle Right, Bottom Left, Bottom Middle, Bottom Right, Detail  NOTE Press [Detail] to set the stamp position using numeric values, and to set the stamp angle.
Font	Set the font of the text stamp. Value Size: Font sizes registered in Font (Text Stamp) on page 8-20 are displayed. Character Border: Off, Circle, Rectangle, Underline Style: None, Bold, Italic, Bold/Italic Font: Courier, Letter Gothic Color: Black, Red, Green, Blue, Cyan, Magenta, Yellow, White Density: 10 to 100% (in 10% increments) Display Pattern: Transparent, Clipping, Overwrite
Bates Stamp	Select whether to print a bates stamp on all storing jobs. Value: Off, On  NOTE When [On] is selected, the Bates Stamp settings cannot be changed when storing.
Edit Bates Stamp	Set the default Bates Stamp. Value: Date, User Name, Serial Number, Numbering, Text 1, Text 2, Date Format, Numbering Default, Position, Font  NOTE To set [Text 1] or [Text 2], press [Change] below and enter a maximum of 32 characters for the text string. To set [Date], press [Date Format] and set the date display format. To set [Numbering], press [Numbering Default] and set the starting sequence number (1 to 9999999). When you press [Detail] in "Position", the stamp position can be specified using numeric values.

Manual Staple

System Menu  **Common Settings**

NOTE

Only displayed when the optional 4,000-Sheet Finisher is installed.

Item	Description
Manual Staple	Select whether to use Manual Staple. Value: Off, On  NOTE If you selected [On], set the time until manual stapling mode is automatically cancelled. The setting range is 5 to 60 seconds (in 5-second increments).
Staple Position	Set the default Staple Position. Value: A4 Long Edge, Letter Long Edge

Offset Documents by Job

System Menu  **Common Settings**

Item	Description
Offset Documents by Job	Select whether to offset documents by Job. Value: Off, On  NOTE This function is displayed when an optional 1,000-Sheet Finisher or 4,000-Sheet Finisher is installed.

Low Toner Alert Level

System Menu  **Common Settings**

Item	Description
Low Toner Alert Level	Set the amount of remaining toner to alert low toner. Value: Off, On  NOTE Selecting [Off] alerts you low toner when the amount of remaining toner becomes 5%. If [On] is selected, set the amount of remaining toner to alert. The setting range is 5 to 100% (in 1% increments).

Offset One Page Documents

System Menu  **Common Settings**

Item	Description
Offset One Page Documents	<p>Set whether one-page documents are sorted. Value: Off, On</p> <p> NOTE This function is displayed when an optional 1,000-Sheet Finisher or 4,000-Sheet Finisher is installed.</p>

Display Status/Log

System Menu  **Common Settings**

Item	Description
Display Status/Log	Set the display method of the Status/Log.
Display Jobs Detail Status	Value: Show All, My Jobs Only, Hide All
Display Jobs Log	Value: Show All, My Jobs Only, Hide All
Display FAX Log*	Value: Show All, Hide All

* Displayed only when the optional FAX Kit is installed.

Message Banner Print

System Menu  **Common Settings**

Item	Description
Message Banner Print	<p>Set whether the confirmation screen appears before each sheet is printed when printing multiple banner sheets. Value: Off, On</p>

Customize Status Display

System Menu   **Common Settings**

Item	Description
Customize Status Display	Set the items that appear in the status screens for printing jobs, sending jobs, and storing jobs.
Printing Jobs Column 1	Value: Job Name, User Name, Print Pages x Copies, Total Printed Pages
Printing Jobs Column 2	Value: Job Name, User Name, Print Pages x Copies, Total Printed Pages
Sending Jobs Column 1	Value: Job Name, User Name, Destination, Original Pages, Color/Black & White
Sending Jobs Column 2	Value: Job Name, User Name, Destination, Original Pages, Color/Black & White
Storing Jobs Column 1	Value: Job Name, User Name, Original Pages, Color/Black & White
Storing Jobs Column 2	Value: Job Name, User Name, Original Pages, Color/Black & White

Function Key Usage

System Menu   **Common Settings**

Item	Description
Function Key Usage	Select whether to enable the Copy Key, Send Key, and FAX Key on the operation panel.
Copy Key	Value: Disable, Enable
Send Key	Value: Disable, Enable
FAX Key*	Value: Disable, Enable

* Displayed only when the optional FAX Kit is installed.

Message Board Settings

System Menu



▶ Common Settings

Item	Description
Message Board	Select whether to use the Message Board. Value: Off, On
Message List	Configure settings for the registered message board.
Add	Add a new message board.
Device to Show	Select where to show the message. Value Hide: Displays no message. Operation Panel: Displays a message on the operation panel. Embedded Web Server: Displays a message in Command Center RX. Panel + Web Server: Displays a message in the operation panel and the Command Center RX.
Message Type	Select the message type. Value: Normal, Alert, Prohibition
Place to Show	Select where to show the message in the touch panel. Value: Login Screen: Login screen of user login administration Home Screen: Home Screen Login Screen+Home Screen: Login screen and Home screen of user login administration
Priority Show	Displays the message on the message board. Value: Off, On
Title	Enter a maximum of 30 characters for the title to display on the message board.
Body	Enter a maximum of 300 characters for the body to display on the message board.
Delete	Deletes the message board selected on the list.
Raise Priority	Raise the priority of the message board selected on the list.
Lower Priority	Lower the priority of the message board selected on the list.
Detail	Display information on the selected message board.

Remote Printing

System Menu



▶ Common Settings

Item	Description
Remote Printing	Select whether to prohibit printing that is performed without operating the machine. When [Prohibit] is selected, a document that has been stored in the document box from the printer driver can be printed from the machine. This prevents another person from seeing that document. Value: Prohibit, Permit  NOTE If [Prohibit] is selected, printing and storing using Quick Copy and Proof and Hold functions are disabled. Printing a received FAX (optional) is not prohibited.

Home

System Menu  **Home**

Configure settings for Home screen.

 [Editing the Home Screen \(page 3-5\)](#)

Copy

System Menu  **Copy**

Configure settings for copying functions.

Item	Description
Paper Selection	Set the default paper selection. Value: Auto, Default Paper Source
Auto Image Rotation Action	Set whether the image is rotated when the orientation of the document to be printed is different from the orientation of the paper. Value Unrotated Manual Copy: If a paper source or zoom ratio is specified, the image is not rotated. Apply All: Rotates all images. Follow Image Size: The image is rotated if the rotated image fits on the paper.  NOTE This function is only enabled when [On] is selected in Auto Image Rotation on page 6-52 .
Auto Paper Selection	If [Auto] is selected for Paper Selection, set the paper size selection method when the zoom changes.*1 Value Most Suitable Size: Selects paper size based on the current zoom and the size of the original. Same as Original Size: Selects paper that matches the size of the original, regardless the zoom.
Auto % Priority	When a paper source of different size from the original is selected, select whether automatic zoom (reduce/zoom) is performed.*1 Value: Off, On
Paper Size for Small Original	Specify the paper size to be used for a case where the original is too small to be detected in the Auto Paper Selection mode. Value: Default Paper Source, A4, A4-R, A5-R, A6-R, B5, B5-R, B6-R, Letter, Letter-R, Statement-R
Preset Limit	Restrict the number of copies that can be made at one time. Value: 1 to 999 copies

Item	Description
Reserve Next Priority	Specify whether the default screen appears when a subsequent copy job is reserved while printing is in progress. To have the default screen appear, select [On]. Value: Off, On
Quick Setup Registration	Select the functions to be registered for Quick Setup. Six keys of the Quick Setup screen are allocated to typical functions but can be changed as necessary. Six items in the following options are available. Value: Paper Selection, Zoom, Staple/Punch^{*2}, Density, Duplex, Combine, Collate/Offset, Original Image, Original Size, Original Orientation, Continuous Scan, Background Density Adj.

*1 If you want to enable the changed defaults immediately, move to the function screen and press the [Reset] key.



*2 This setting is displayed when the optional 1,000-Sheet Finisher or 4,000-Sheet Finisher is installed. When a punching unit is not installed, this item name is "Staple".

Send

System Menu  **Send**

Configure settings for sending functions.

Item	Description
Quick Setup Registration	Select the functions to be registered for Quick Setup. Six keys of the Quick Setup screen are allocated to typical functions but can be changed as necessary. Six items in the following options are available. Value: Original Size, 2-sided/Book Original^{*1}, Sending Size, Original Orientation, File Format, Density, Original Image, Scan Resolution, FAX TX Resolution^{*2}, Color Selection, Zoom, Continuous Scan, Background Density Adj.
Dest. Check before Send	Select whether to display the confirmation screen of destinations after pressing the [Start] key when performing sending jobs. Value: Off, On
Color Type	Set the color type when you send color documents. Value: [RGB], [sRGB]
Entry Check for New Dest.	When adding new destination, select whether to display the entry check screen to check the entered destination. Value: Off, On
Default Screen	Set the default screen displayed when you press the [Send] key. Value: Destination, Address Book

Item	Description
Send and Forward	Select whether to forward the original to another destination when sending images.
Forward	Select whether to forward the original. Value: Off, On  NOTE When selecting [On], select rules to forward from [E-mail], [Folder(SMB)], [Folder(FTP)], [FAX] ^{*2} , [i-FAX(Via server-On)] ^{*3} , and [i-FAX(Via server-Off)] ^{*3} .
Destination	Set the destination to which the original is forwarded. One destination can be set. Follow the steps below to register the destination. <ul style="list-style-type: none"> • Address Book • Address Entry (E-mail) • Address Entry (folder)  Specifying Destination (page 5-26)
Color Setting	Configure the color settings for forwarded original. Value: Auto Color (Color/Gray), Auto Color (Color/B & W), Full Color, Grayscale, Black & White
Scan Resolution	Select resolution for stored original. Value: 600x600dpi, 400x400dpi Ultra Fine, 300x300dpi, 200x400dpi Super Fine, 200x200dpi Fine, 200x100dpi Normal
File Format	Select the file format of forwarded original. For details on setting value, refer to File format for Send and Forward on page 8-31 .
File Separation	Set whether originals are divided into multiple files before being forwarded. Value: Off, Each Page
E-mail Subject	Enter a maximum of 60 characters for the subject of forwarded E-mail.  Character Entry Method (page 11-10)
FTP Encrypted TX	Set whether originals are encrypted before being forwarded. Value: Off, On  NOTE This function is displayed when SSL is set to [On] in Security Settings.  Security Settings (page 8-46)
New Destination Entry	Select whether to permit direct entry of destination. Value: Prohibit, Permit
Recall Destination	Select whether to permit usage of [Recall] on the Send screen. Value: Prohibit, Permit
OCR Text Recognition Act.	Configure settings for OCR Text Recognition Action. Value: Speed Priority, Quality Priority  NOTE This function can only be used when the optional OCR Scan Activation Kit is installed.  Scan extension kit(A) "OCR Scan Activation Kit" (page 11-7)
HighCompressionPDF Mode	Select the compression method for sending High-Compression PDF. Value: Text Priority, File Size Priority

*1 When the optional document processor is not installed, this is set to "Book Original".

*2 Displayed only when the optional FAX Kit is installed.

*3 Displayed only when the optional Internet FAX Kit is installed.

File format for Send and Forward

System Menu



Send



Send and Forward

Select the file format for forwarded original.

The table below lists the file formats and their details.

File format	Adjustable range of image quality	Color setting
PDF*	1 Low Quality (High Comp.) to 5 High Quality (Low Comp.)	Auto Color (Color/Grayscale), Auto Color (Color/Black and White), Full Color, Grayscale, Black and White
TIFF	1 Low Quality (High Comp.) to 5 High Quality (Low Comp.)	Auto Color (Color/Grayscale), Auto Color (Color/Black and White), Full Color, Grayscale, Black and White
JPEG	1 Low Quality (High Comp.) to 5 High Quality (Low Comp.)	Auto Color (Color/Grayscale), Full Color, Grayscale
XPS	1 Low Quality (High Comp.) to 5 High Quality (Low Comp.)	Auto Color (Color/Grayscale), Auto Color (Color/Black and White), Full Color, Grayscale, Black and White
High Comp. PDF*	Compression Ratio Priority, Standard, Quality Priority	Auto Color (Color/Grayscale), Auto Color (Color/Black and White), Full Color, Grayscale

* File format can be selected. (Value: [Off] / [PDF/A-1a] / [PDF/A-1b])



NOTE

When [High Comp. PDF] is selected, you cannot adjust the image quality.

PDF Encryption Functions

If you have selected PDF or High Comp. PDF for file format, you can restrict the access level for displaying, printing, and editing PDF's by assigning a secure password.

Items that can be set vary depending on the setting selected in "Compatibility".

When [Acrobat 3.0 or later] is selected

System Menu



▶ Send ▶ Send and Forward ▶ PDF/High Comp. PDF

Item		Value	Description
Password to Open Document		Off, On	Enter the password to open the PDF file. Press [Password], enter a password (up to 256 characters) and then press [OK]. Press [Confirmation] to enter the password again for confirmation, and press [OK].
Password to Edit/Print Document		Off, On	Enter the password to edit the PDF file. Press [Password], enter a password (up to 256 characters) and then press [OK]. Press [Confirmation] to enter the password again for confirmation, and press [OK]. When you have entered the password to edit/print document, you can specifically limit the operation.
Detail	Printing Allowed	Not Allowed, Allowed	Restricts printing of the PDF file.
	Changes Allowed	Not Allowed	Disables the change to the PDF file.
		Commenting	Can only add commenting.
		Page Layout except extracting Pages	Can change the page layout except extracting the pages of the PDF file.
		Any except extracting Pages	Can conduct all operations except extracting the pages of the PDF file.
Copying of Text/Images/Others	Disable, Enable	Restricts the copying of text and objects on the PDF file.	

When [Acrobat 5.0 or later] is selected

System Menu



▶ Send ▶ Send and Forward ▶ PDF/High Comp. PDF



Item		Value	Description
Password to Open Document		Off, On	Enter the password to open the PDF file. Press [Password], enter a password (up to 256 characters) and then press [OK]. Press [Confirmation] to enter the password again for confirmation, and press [OK].
Password to Edit/Print Document		Off, On	Enter the password to edit the PDF file. Press [Password], enter a password (up to 256 characters) and then press [OK]. Press [Confirmation] to enter the password again for confirmation, and press [OK]. When you have entered the password to edit/print document, you can specifically limit the operation.
Detail	Printing Allowed	Not Allowed	Disables the printing of PDF file.
		Allowed (Low Resolution only)	Can print the PDF file only in low resolution.
		Allowed	Can print the PDF file in original resolution.
	Changes Allowed	Not Allowed	Disables the change to the PDF file.
		Inserting/Deleting/ Rotating Pages	Can only insert, delete, and rotate the pages of the PDF file.
		Commenting	Can only add commenting.
		Any except extracting Pages	Can conduct all operations except extracting the pages of the PDF file.
Copying of Text/Images/Others	Disable, Enable	Restricts the copying of text and objects on the PDF file.	

Document Box/Removable Memory

System Menu



Document Box/Removable Memory

Item	Description
Custom Box	Configure settings for Custom Box.
Add/Edit Box	For details, refer to Using a Custom Box on page 5-53 .
Default Setting	Auto File Deletion Time Set the time to automatically delete stored documents.
FAX Box^{*1}	For details, refer to the FAX Operation Guide .
Job Box	Configure settings for Job Box.
Quick Copy Job Retention	To maintain free space on the hard disk, you can set the maximum number of stored jobs. Value: number between 0 and 300  NOTE When 0 is set, Quick Copy cannot be used.
Repeat Copy Job Retention	To maintain free space on the hard disk, you can set the maximum number of stored jobs. Value: number between 0 and 50  NOTE This function will not be displayed when the optional Data Security Kit is activated. When 0 is set, Repeat Copy cannot be used.
Deletion of Job Retention	This setting specifies that documents, such as Private Printing, Quick Copying, or Proof and Hold Printing, saved temporarily in the job box are automatically deleted after they have been saved for a set time. Value: Off, 1 hour, 4 hours, 1 day, 1 week  NOTE This function is valid for documents saved after the function is set. Regardless of this function setting, temporary documents are deleted when the main power switch is turned off.
Polling Box^{*1}	For details, refer to the FAX Operation Guide .
Quick Setup Registration	Select the functions to be registered for Quick Setup. Six keys of the Quick Setup screen are allocated to typical functions but can be changed as necessary.
Store File	Select the functions to be registered for Store File Quick Setup. Color Selection, Storing Size, Density, 2-sided/Book Original^{*2}, Scan Resolution, Zoom, Original Orientation, Original Size, Original Image, Continuous Scan, Background Density Adj. Value: Off, Key 1 to 6
Print	Select the functions to be registered for Print Quick Setup. Paper Selection, Collate/Offset, Staple/Punch^{*3}, Duplex, Combine, Delete after Printed Value: Off, Key 1 to 6
Send	Select the functions to be registered for Send Quick Setup. Sending Size, FAX TX Resolution^{*1}, File Format, Delete after Transmitted Value: Off, Key 1 to 6

*1 Displayed only when the optional FAX Kit is installed.

*2 When the optional document processor is not installed, this is set to "Book Original".

*3 This setting is displayed when the optional 1,000-Sheet Finisher or 4,000-Sheet Finisher is installed. When a punching unit is not installed, this item name is "Staple".

FAX



System Menu  **FAX**

Configure settings for FAX. For details, refer to the **FAX Operation Guide**.

Printer

System Menu  **Printer**

When printing from computers, settings are generally made on the application software screen. However, the following settings are available for configuring the defaults to customize the machine.

Item	Description
Emulation	<p>Set the emulation for operating this machine by commands oriented to other types of printers. Value: PCL6, IBM Proprinter, Line Printer, EPSON LQ-850, KPDL, KPDL(Auto)</p> <p> NOTE IBM Proprinter, Line Printer, and EPSON LQ-850 are displayed when the optional Emulation Upgrade Kit is installed. If you selected [KPDL(Auto)], set "Alternative Emulation", too. When you have selected [KPDL] or [KPDL(Auto)], set "KPDL Error Report", too.</p>
Alt Emulation	<p>When you have selected [KPDL(Auto)] as emulation mode, you can switch between KPDL and another emulation mode (alternative emulation) automatically according to the data to print. Value: PCL6, IBM Proprinter, Line Printer, EPSON LQ-850</p> <p> NOTE IBM Proprinter, Line Printer, and EPSON LQ-850 are displayed when the optional Emulation Upgrade Kit is installed.</p>
KPDL Error Report	<p>When an error has occurred during printing in KPDL emulation mode, set whether the error report is output. Value: Off, On</p>
EcoPrint	<p>EcoPrint conserves toner when printing. This is recommended for test copies where lighter printing is not a problem. Value: Off, On</p>
Toner Save Level (EcoPrint)	<p>Select the default Toner Save Level (EcoPrint). Value: 1 (Low) to 5 (High)</p> <p> NOTE Raising the level reduces toner consumption, but image quality falls.</p>
Override A4/Letter	<p>Select whether to treat A4 size and Letter, which are similar in size, as the same size when printing. Value Off: A4 and Letter are not regarded as the same in size. On: A4 and Letter are regarded as the same in size. The machine will use whichever size is in the paper source.</p>
Duplex	<p>Select binding orientation for duplex mode. Value: 1-sided, 2-sided(Bind Long Edge), 2-sided(Bind Short Edge)</p>
Copies	<p>Set the default number of copies, from 1 to 999. Value: 1 to 999 copies</p>

Item	Description
Orientation	Set the default orientation, [Portrait] or [Landscape]. Value: Portrait, Landscape
Form Feed Timeout	Receiving print data from the computer, the machine may sometimes wait if there is no information signaling that the last page does not have any more data to be printed. When the preset timeout passes, the machine automatically prints the document. The options are between 5 and 495 seconds. Value: 5 to 495 seconds
LF Action	Set the line feed action when the machine receives the line feed code (character code 0AH). Value: LF Only, LF and CR, Ignore LF
CR Action	Set the character return action when the machine receives the character return code (character code 0DH). Value: CR Only, LF and CR, Ignore CR
Job Name	Set whether the job name set in the printer driver is displayed. Value: Off, On  NOTE When selecting [On], select the job name to be displayed from [Job Name], [Job No. & Job Name], or [Job Name & Job No.].
User Name	Set whether the user name set in the printer driver is displayed. Value: Off, On
Paper Feed Mode	While printing from the computer, select how to feed paper when the paper source and type are specified. Value Auto: Search the paper source that matches the selected paper size and type. Fixed: Print on paper loaded in the specified paper source.
KIR	The machine is equipped with the smoothing function, which realizes an excellent printing of about 9600 dpi (600 dpi × 15 gradation) × 600 dpi. Value: Off, On



Report

Print reports to check the machine settings and status. Default settings for printing the result reports can also be configured.

Print Report

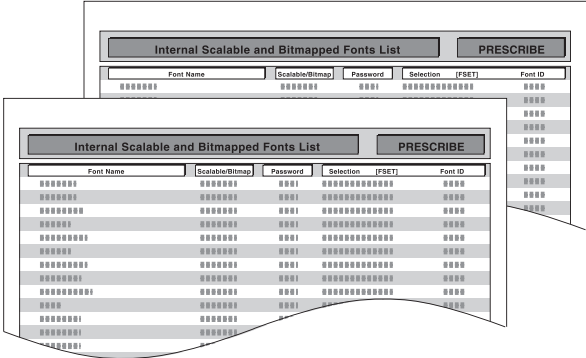
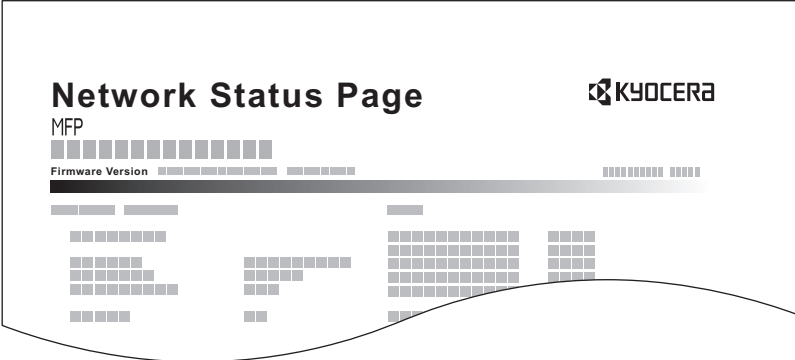
System Menu  Report

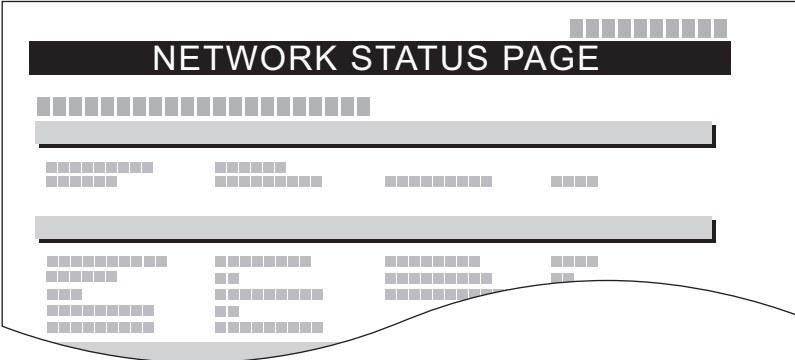
Item	Description
<p>Status Page</p>	<p>Prints the status page, allowing you to check the information including current settings, available memory space, and optional equipment installed.</p> 
<p>Font List</p>	<p>Prints the font list, allowing you to check the font samples installed in the machine.</p> 
<p>Network Status</p>	<p>Prints the network status, allowing you to check the information including network interface firmware version, network address and protocol.</p> 

Item	Description
Service Status	Prints the service status. More detailed information is available than on the Status Page. Service personnel usually print the service status pages for maintenance purpose.
Optional Network Status	<p>Prints the optional network status, allowing you to check the information including optional network interface firmware version, network address and protocol.</p> <div style="text-align: center;">  </div> <p> NOTE This function is displayed when the optional Network Interface Kit is installed.</p>

Admin Report Settings

System Menu  **Report**

Configure settings for fax functions. For details, refer to the **FAX Operation Guide**.

Result Report Settings

System Menu  **Report**

Item	Description
Send Result Report	Automatically print a report of transmission result when a transmission is complete.
E-mail/Folder	Print a report of E-mail/Folder transmission results. Value: Off, On, Error Only
FAX*1	For details, refer to the FAX Operation Guide .
Canceled before Sending	Print a send result report when the job is canceled before being sent. Value: Off, On
Recipient Format	Select the Recipient Format for the send result report. Value: Name or Destination, Name and Destination
FAX TX Resolution*1	For details, refer to the FAX Operation Guide .
Job Finish Notice Setting*1	For details, refer to the FAX Operation Guide .
RX Result Report Type*1*2	For details, refer to the FAX Operation Guide .

*1 Displayed only when the optional FAX Kit is installed.

*2 This is not displayed if you selected [Off] for FAX RX Result Report.

Sending Log History

System Menu



Report

Item	Description
Auto Sending	<p>This function automatically sends the log history to the specified destinations whenever a set number of jobs has been logged.</p> <p>Value: Off, On</p> <p> NOTE</p> <p>If [On] is selected, specify the number of job histories. The setting range is 1 to 1,500.</p>
Sending Log History	<p>You can also send the log history to the specified destinations manually.</p>
Destination	<p>Set the destination to which log histories are sent. Only E-mail address can be set.</p>
Job Log Subject	<p>Set the subject automatically entered when sending log histories by E-mail.</p> <p>Value: Up to 60 characters</p>
Personal Information	<p>Select whether to include personal information in the job log.</p> <p>Value: Include, Exclude</p>

Login History Settings

System Menu



Report

Item	Description
Login History	<p>Select whether to record the Login History. Value: Off, On</p> <p> NOTE If [On] is selected, set the number of histories to be recorded. The setting range is 1 to 1,000.</p>
Auto Sending	<p>Select whether the login history is automatically sent to the set address when the number of entries reaches the number set in "Login History". Value: Off, On</p> <p> NOTE This function is displayed when "Login History" is set to [On].</p>
Destination	<p>Set the destination to which login histories are sent. E-mail address only can be set as destination. NOTE This function is displayed when "Login History" is set to [On].</p>
Subject	<p>Set the subject automatically entered when sending login histories by E-mail. Value: Up to 60 characters</p> <p> NOTE This function is displayed when "Login History" is set to [On].</p>
Log Reset	Resets the recorded login histories.

NOTE

If the user authentication screen appears, enter your login user name and login password and press [Login]. For this, you need to login with administrator privileges. The factory default login user name and login password are set as shown below.

Model Name	Login User Name	Login Password
3501i	3500	3500
4501i	4500	4500
5501i	5500	5500

Device Log History Settings

System Menu



Report

Item	Description
Device Log History	<p>Select whether to record the device log history.</p> <p>Value: Off, On</p> <p> NOTE</p> <p>If [On] is selected, set the number of histories to be stored. The setting range is 1 to 1,000.</p>
Auto Sending	<p>Select whether the device log history is automatically sent to the set address when the number of entries reaches the number set in "Device Log History".</p> <p>Value: Off, On</p> <p> NOTE</p> <p>This function is displayed when "Device Log History" is set to [On].</p>
Destination	<p>Set the destination to which device log histories are sent. E-mail address only can be set as destination.</p> <p> NOTE</p> <p>This function is displayed when "Device Log History" is set to [On].</p>
Subject	<p>Set the subject automatically entered when sending device log histories by E-mail.</p> <p>Value: Up to 60 characters</p> <p> NOTE</p> <p>This function is displayed when "Device Log History" is set to [On].</p>

NOTE

If the user authentication screen appears, enter your login user name and login password and press [Login]. For this, you need to login with administrator privileges. The factory default login user name and login password are set as shown below.

Model Name	Login User Name	Login Password
3501i	3500	3500
4501i	4500	4500
5501i	5500	5500

Secure Comm. Error Log

System Menu



Report

Item	Description
Secure Comm. Error Log	<p>Select whether to record the secure communication error log history. Value: Off, On</p> <p> NOTE If [On] is selected, set the number of histories to be stored. The setting range is 1 to 1,000.</p>
Auto Sending	<p>Select whether the secure communication error log history is automatically sent to the set address when the number of entries reaches the number set in "Secure Comm. Error Log". Value: Off, On</p> <p> NOTE This function is displayed when "Secure Communication Error Log History" is set to [On].</p>
Destination	<p>Set the destination to which secure communication error log histories are sent. E-mail address only can be set as destination.</p> <p> NOTE This function is displayed when "Secure Communication Error Log History" is set to [On].</p>
Subject	<p>Set the subject automatically entered when sending secure communication error log histories by E-mail. Value: Up to 60 characters</p> <p> NOTE This function is displayed when "Secure Communication Error Log History" is set to [On].</p>

NOTE

If the user authentication screen appears, enter your login user name and login password and press [Login]. For this, you need to login with administrator privileges. The factory default login user name and login password are set as shown below.

Model Name	Login User Name	Login Password
3501i	3500	3500
4501i	4500	4500
5501i	5500	5500

System/Network

Configure machine system settings.

Network

System Menu





▶ **System/Network**

Configure network settings.

Host Name

Item	Description
Host Name	Check the host name of the machine. Host name can be changed from Command Center RX.  Changing Device Information (page 2-36)





TCP/IP Setting

Item	Description
TCP/IP	Select whether to use TCP/IP Protocol. Value: Off, On
IPv4	Set up TCP/IP (IPv4) to connect to the network. This setting is available when [TCP/IP] is set to [On].
IP Address	Set the IP addresses. Value: ###.###.###.###  NOTE When DHCP is set to [On], this function will be grayed out and the value cannot be entered.
Subnet Mask	Set the IP subnet masks. Value: ###.###.###.###  NOTE When DHCP is set to [On], this function will be grayed out and the value cannot be entered.
Default Gateway	Set the IP gateway addresses. Value: ###.###.###.###  NOTE When DHCP is set to [On], this function will be grayed out and the value cannot be entered.
DHCP	Select whether to use the DHCP (IPv4) server. Value: Off, On
Auto-IP	Select whether to use Auto-IP. Value: Off, On



IMPORTANT





After changing the setting, restart the network or turn the machine OFF and then ON.

Item	Description
IPv6	Set up TCP/IP (IPv6) to connect to the network. This setting is available when [TCP/IP] is [On].
IPv6	Select whether to use IPv6. Value: Off, On  NOTE Selecting [On] displays IP address in [IP Address (Link Local)] after restarting the network.
RA (Stateless)	Select whether to use RA (Stateless). Value: Off, On  NOTE This function is displayed when [IPv6] is set to [On]. Selecting [On] displays IP address in [IP Address (Stateless)] after restarting the network.
Manual Setting	Manually specify the IP address, prefix length, and gateway address of TCP/IP (IPv6). Value IP Address (Manual): (numbers (128 bit in total) separated by colons) Prefix Length: 0 to 128 Default Gateway: ###.###.###.###  NOTE This function is displayed when [IPv6] is set to [On]. To enter "Default Gateway", set [RA (Stateless)] to [Off].
DHCP	Select whether to use the DHCP (IPv6) server. Value: Off, On  NOTE This function is displayed when [IPv6] is set to [On]. Selecting [On] displays IP address in [IP Address (Stateful)] after restarting the network.
Bonjour	Select whether to use Bonjour. Value: Off, On
IPSec	Select whether to use IPSec. Value: Off, On

**IMPORTANT**

After changing the setting, restart the network or turn the machine OFF and then ON.

Protocol Settings

Item	Description
SMTP (E-mail TX)	Select whether to send E-mail using SMTP. Value: Off, On
POP3 (E-mail RX)	Select whether to receive E-mail using POP3. Value: Off, On
FTP Client (Transmission)	Select whether to send documents using FTP. When selecting [On], set the FTP Port Number. Use the default port 21. Value: Off, On (Port Number: 1 to 65535)
FTP Server (Reception)	Select whether to receive documents using FTP.* ¹ Value: Off, On
SMB Client (Transmission):	Select whether to send documents using SMB. When selecting [On], set the SMB Port Number. Use the default port 139. Value: Off, On (Port Number: 1 to 65535)
NetBEUI	Selects whether to receive documents using NetBEUI.* ¹ Value: Off, On
WSD Scan	Select whether to use WSD Scan.* ¹ Value: Off, On
WSD Print	Select whether to use WSD Print.* ¹ Value: Off, On
i-FAX	Select whether to use i-FAX. Value: Off, On  NOTE This function is displayed when the optional Internet FAX Kit is activated.
DSM Scan	Select whether to use DSM scan. Value: Off, On
ThinPrint	Select whether to use ThinPrint. When selecting [On], set the SMB default Port Number. Use the default port 4000.* ¹ , * ² Value: Off, On (Port Number: 1 to 32767)  NOTE This function is displayed only when the optional ThinPrint Option is activated.
Thin Print over SSL	To use Thin Print over SSL, press [Thin Print over SSL] and select [On]. Value: Off, On  NOTE When selecting [On], the certificates must be installed. For details, refer to the Command Center RX User Guide .
LPD	Selects whether to receive documents using LPD.* ¹ Value: Off, On
Raw	Select whether to receive documents using Raw Port.* ¹ Value: Off, On
IPP	Selects whether to receive documents using IPP. When selecting [On], set the IPP Port Number. Use the default port 631.* ¹ , * ² Value: Off, On
IPP over SSL	Selects whether to receive documents using IPP over SSL. When selecting [On], set the IPP default Port Number. Use the default port 443.* ¹ , * ² Value: Off, On (Port Number: 1 to 32767)  NOTE When selecting [On], the certificates must be installed. For details, refer to the Command Center RX User Guide .

Item	Description
HTTP	Select whether to communicate using HTTP. ^{*1} Value: Off, On
HTTPS	Select whether to communicate using HTTPS. ^{*1, *2} Value: Off, On
LDAP	Select whether to use LDAP. Value: Off, On
SNMPv1/v2c	Select whether to communicate using SNMP. ^{*1} Value: Off, On
SNMPv3	Select whether to communicate using SNMPv3. ^{*1} Value: Off, On
Enhanced WSD	Select whether to use Enhanced WSD. ^{*1} Value: Off, On
Enhanced WSD over SSL	Select whether to use Enhanced WSD (SSL). ^{*1, *2} Value: Off, On  NOTE Selecting [Off] will disable the functionality of WIA, TWAIN and Network FAX drivers.

*1 The setting will be changed after restarting the device or network.

*2 Set "SSL" to [On] in [Security Settings on page 8-46](#).

IMPORTANT

After changing the setting, restart the network or turn the machine OFF and then ON.

Security Settings

Item	Description
SSL	Select whether to use SSL for communication. Value: Off, On

LAN Interface

Item	Description
LAN Interface	Specify the settings for the LAN interface to be used. Value: Auto, 10BASE-T Half, 10BASE-T Full, 100BASE-T Half, 100BASE-TX Full, 1000BASE-T

IMPORTANT

After changing the setting, restart the network or turn the machine OFF and then ON.

Restart Network

Item	Description
Restart Network	Restarts the network.

Proxy

Item	Description
Proxy	Set the proxy for connection to the Internet from an application. Value: Off, On
Use the Same Proxy Server for All Protocols	Set whether the same proxy server is used for all protocols. To use the same proxy server, select the [Use the Same Proxy Server for All Protocols] checkbox.
Proxy Server (HTTP)	Set a proxy server (HTTP). Value: (Enter the proxy address and port number.)
Proxy Server (HTTPS)	Set a proxy server (HTTPS). This setup is available when "Use the Same Proxy Server for All Protocols" is [Off]. Value: (Enter the proxy address and port number.)
Do Not Use Proxy for Following Domains	Set domains for which no proxy is used. Value: (Enter the domain name.)



Optional Network

System Menu  **System/Network**

 **NOTE**

This function is displayed when the optional Network Interface Kit is installed.

Basic

Item	Description
Host Name	Check the host name of the machine. Host name can be changed from Command Center RX.  Changing Device Information (page 2-36)
TCP/IP Setting	For details on setting value, refer to TCP/IP Setting on page 8-43 .
NetWare	Use NetWare to receive documents. See the Operation Guide for the optional network interface card for details. Value: Off, On
AppleTalk	Selects whether to receive documents using AppleTalk.* Value: Off, On
LAN Interface	Select the LAN Interface type.* Value: Auto, 10BASE-T Half, 10BASE-T Full, 100BASE-T Half, 100BASE-T Full, 1000BASE-T  NOTE This function is displayed when the optional Network Interface Kit is installed.
MAC Address Filter	Select whether to use MAC Address Filter. See the Operation Guide for the optional network interface card for details. Value: Off, On
Restart Network	Restarts the network card of the device.

* The setting will be changed after restarting the device or network.

Wireless Network

**NOTE**

This function is displayed when the optional Wireless Interface Kit is installed.

Item	Description
Connection Status	When the optional Wireless Interface Kit is installed, you can check the wireless LAN status.
Quick Setup Wizard	If the machine will connect to an access point that supports the automatic wireless network setup, connection settings can be configured by Quick Setup.
Available Network	Displays access points to which the machine can connect.
Push Button Method	If the access point supports the push button method, wireless settings can be configured using the push button. This setting executes push button, and the connection is started by pressing the push button on the access point.
PIN Code Method(Device)	Starts connection using the machine's PIN code. Enter the PIN code into the access point. The PIN code of the machine is automatically generated.
PIN Code Method(Terminal)	Starts connection using the PIN code of the access point. Enter the PIN code of the access point.
Custom Setup	The detailed settings for wireless LAN can be changed.
Network Name(SSID)	Set the SSID (Service Set Identifier) of the wireless LAN to which the machine connects. NOTE Up to 32 characters can be entered.
Connection Mode	Set the connection mode. Value: Ad Hoc, Infrastructure NOTE Ad Hoc: Directly communicates with the device without going through an access point. This method cannot be used to connect to two or more devices. Infrastructure: Performs communication through an access point.
Channel	Set channel. Use [-] / [+] or the numeric keys to enter a number. Value: 1 to 11
Network Authentication	Select network authentication type. To select other options, open the device home page from a computer. Value: Open, Shared, WPA-PSK^{*1}, WPA2-PSK^{*1}
Encryption	Select encryption method and enter the Preshared key. The setting values vary depending on the Network Authentication setting. When Network Authentication is set to [Open] or [Shared] Value: Disable, WEP When Network Authentication is set to [WPA-PSK] or [WPA2-PSK] Value: TKIP^{*2}, AES, Auto^{*2}, Preshared Key NOTE If [WEP] is selected, enter the WEP key. Up to 26 characters can be entered. If [Preshared Key] is selected, enter the Preshared key. Enter the value in 8 to 64 characters.

*1 Not displayed if you selected [Ad Hoc] for "Connection Mode".

*2 Not displayed if you selected [WPA2-PSK] for "Network Authentication".

Network Interface (Send)

System Menu  **System/Network**



NOTE

This function is displayed when the optional Network Interface Kit is installed.

Item	Description
Network Interface (Send)	Specify the network interface card to be used for send function and connecting to external address book. Value: Standard, Optional Network

Security Level

System Menu  **System/Network**

Item	Description
Security Level	Specify the security level. Value: Low: This is the mode in which the service personnel performs maintenance work. Do not set to this mode. High: This is the security setting we recommend. Use this setting normally. Very High: In addition to [High] setting, this setting disables the machine settings to be changed from external command.

Interface Block Setting

System Menu  **System/Network**

This allows you to protect this machine by blocking the interface with external devices such as USB hosts or optional interfaces.

Item	Description
USB Host	This locks and protects the USB port (A1) or USB port (A2) (USB host). Value: Unblock, Block
USB Device	This locks and protects the USB interface connector (B1) (USB Device). Value: Unblock, Block
USB Storage	This locks and protects the USB memory slot (A1). Value: Unblock, Block  NOTE This function is available when USB Host is set to [Unblock].
Optional Interface 1	This locks and protects the optional interface slots (OPT1 or OPT2). Value: Unblock, Block
Optional Interface 2	





IMPORTANT

After changing the setting, restart the system or turn the machine OFF and then ON.

Data Security

System Menu  **System/Network**

Configure settings for data stored in the machine's hard disk and memory.

Item	Description
Hard Disk Initialization	Initializes the system and the erasure method for data stored on the machine's hard disk. For details, refer to the Data Security Kit (E) Operation Guide .  NOTE This function is displayed when the optional Data Security Kit is activated.
Data Sanitization	Completely erases address information and image data saved in the machine.  NOTE Up to 8 hours is required to complete this processing, depending on the amount of data stored. Once in progress, the processing cannot be canceled. Before executing this function, disconnect modular, network, and other cables. Do not turn off the main power switch while sanitizing the data. If the main power is turned off during data erasing, erasing will be executed automatically when the power is restored, however, complete erasure cannot be guaranteed.
Software Verification	Verify the installed software. Press [Start] to start verification. If an error occurs during software verification, contact your dealer or service representative.

Information erased

Category	Data erased
Devices/jobs	<ul style="list-style-type: none"> • Job settings configured by users • Network settings • Image data saved in Document Box, etc. • Data registered in One Touch keys • Job histories • User information (user list, address book, Document Box registered by the user, etc.) • Account information of job accounting • Network certificates • Initial screen on machine changed by service representative
FAX*	<ul style="list-style-type: none"> • Fax settings configured by users • Communication restriction settings • Encryption key settings • Transmission histories • Scheduled jobs • Conditional reception/forwarding settings
Application/program	<ul style="list-style-type: none"> • Application/program added by a user or service representative • Trial functions

* Only when the optional FAX Kit is installed.

Document Guard

System Menu  System/Network

**NOTE**

This function is displayed when the Printed Document Guard Kit is installed.

Item	Description
Document Guard	<p>When the optional Printed Document Guard Kit is installed, careless copying and sending of documents that contain confidential or personal information is prevented.</p> <p>The guard pattern can be embedded in a document using the Security Watermark setting, which is an advanced function of the printer driver. (Refer to the Printer Driver User Guide.)</p> <p>It is recommended that you check the effects of this function in your usage environment.</p> <p>Value: Off, On</p> <p> NOTE</p> <p>When the Document Guard is enabled, restrictions apply to the operation of the machine. For details, refer to Limitations on page 8-52.</p>

Limitations

System Menu  **System/Network**

Operation after guard pattern is detected

Item	Description
All functions	A message indicating that a confidential document was detected is displayed. Scanning of the remaining document pages stops.
Copying function	Printed blank from the point where the guard pattern is detected.
Sending Functions	Stops the sending operation.*
Document Box	Documents are not saved on the machine's hard disk.
FAX	The document is not sent.

* When sending by file separation, document pages scanned prior to detection are sent. If file separation is not performed, the document is not sent.

Restrictions

- The [DP Read Action \(page 6-55\)](#) cannot be selected.
- Faxes are sent by memory transmission.

Disclaimer

- This function does not prevent leakage of information.
We do not bear any liability for damages occurring due to use of the function or inability to use the function.
- The guard pattern may not be detected if printed on paper other than white paper or special paper with a pattern.
- The integrity of detection is not guaranteed.
If misdetection occurs, contact your service representative.

Optional Function

System Menu  **System/Network**

Item	Description
Optional Function	You can use the optional applications installed on this machine.  Optional Applications (page 11-8)

Restart Entire Device

System Menu  **System/Network**

Item	Description
Restart Entire Device	Restart the CPU without turning the main power switch off. Use this to deal with any unstable operation by the machine. (Same as the computer restart.)

Edit Destination

Address Book

System Menu  **Edit Destination**

Configure settings for address book.

 [Adding a Destination \(Address Book\) \(page 3-46\)](#)

One Touch Key

System Menu  **Edit Destination**

Configure settings for One Touch Key.

 [Adding a Destination on One Touch Key \(One Touch Key\) \(page 3-54\)](#)

Print list

System Menu  **Edit Destination**

For details, refer to the **FAX Operation Guide**.

Address Book Defaults

System Menu  **Edit Destination**



Item	Description
Sort	Select the default sort setting of the address for the address book. Value: No., Name
Narrow Down	This procedure can be used to filter (narrow down) the types of destination listed when the address book is displayed. Value: Off, E-mail, Folder, FAX*, i-FAX*, Group
Address Book Type	Select whether the machine's address book or the External Address Book appears when the address book is displayed. Value: Address Book, Ext Address Book

* Displayed only when the optional FAX Kit is installed.

User Login/Job Accounting

System Menu  **User Login/Job Accounting**

Configure settings related to machine management.

 [User Login Setting \(page 9-2\)](#)
 [Job Accounting Setting \(page 9-27\)](#)
 [Unknown ID Job \(page 9-41\)](#)

User Property

System Menu  **User Property**





Allows you to view information about logged in users and edit some of that information.





 [User Login \(page 9-4\)](#)



Date/Timer/Energy Saver

System Menu  **Date/Timer/Energy Saver**

Configure settings related to the date and time.

Item	Description
Date/Time	<p>Set the date and time for the location where you use the machine. If you perform Send as E-mail, the date and time set here will be displayed on the header.</p> <p>Value: Year (2000 to 2037), Month (1 to 12), Day (1 to 31), Hour (00 to 23), Minute (00 to 59), Second (00 to 59)</p> <p> NOTE</p> <p>If you change the date/time while using the trial version of an application, you will no longer be able to use the application.</p>
Date Format	<p>Select the display format of year, month, and date. The year is displayed in Western notation.</p> <p>Value: Month/Day/Year, Day/Month/Year, Year/Month/Day</p>
Time Zone	<p>Set the time difference from GMT. Choose the nearest listed location from the list. If you select a region that utilizes summer time, configure settings for summer time.</p> <p> Setting Date and Time (page 2-23)</p>
Auto Panel Reset	<p>If no jobs are run for a certain period of time, automatically reset settings and return to the default setting. Select to use Auto Panel Reset or not.</p> <p>Value: Off, On</p> <p> NOTE</p> <p>The time allowed to elapse before the panel is reset is set with the Panel Reset Timer on page 8-55.</p>
Auto Error Clear	<p>If an error occurs during processing, processing stops to wait for the next step to be taken by the user. In the Auto Error Clear mode, automatically clear the error after a set amount of time elapses. For details, refer to Responding to Messages on page 10-23.</p> <p>Value: Off, On</p>
Low Power Timer	<p>Set amount of time before entering the Low Power mode.</p> <p>Value:</p> <p>For Europe 1 to 120 minutes (1minute increments)</p> <p>Except for Europe 1 to 240 minutes (1minute increments)</p> <p> Low Power Mode and Auto Low Power Mode (page 3-14)</p>

Item	Description
Panel Reset Timer	<p>If you select [On] for Auto Panel Reset, set the amount of time to wait before Auto Panel Reset. Value: 5 to 495 seconds (in 5 second increments)</p> <p> NOTE This function is displayed when [Device Log History] is set to [On].</p>
Sleep Timer	<p>Set amount of time before entering Sleep. Value: For Europe 1 to 120 minutes (1 minute increments) Except for Europe 1 to 240 minutes (1 minute increments)</p>
Interrupt Clear Timer	<p>Set the period after which the machine reverts to Normal mode when it has been set to Interrupt Copy mode and then left unused. Value: 5 to 495 seconds (in 5 second increments)</p>
Error Job Skip	<p>Set whether a job for which a "Add paper in cassette #" or "Add paper in Multi Purpose tray" error occurred when the job was started is automatically skipped after a set period of time elapses. Value: Off, On</p> <p> NOTE</p> <ul style="list-style-type: none"> • When a job is skipped, it is moved to the end of the job queue. • If [On] is selected, set the time until the job is skipped. The setting range is 5 to 90 (5 second increments).
Error Clear Timer	<p>If you select [On] for Auto Error Clear, set the amount of time to wait before automatically clearing errors. Value: 5 to 495 seconds (in 5 second increments)</p> <p> NOTE This function is displayed when [Auto Error Clear] is set to [On].</p>
Unusable Time*¹	<p>For details, refer to the FAX Operation Guide.</p>
Sleep Rules (models for Europe)	<p>Select whether to use the Sleep mode for the following functions individually:</p> <ul style="list-style-type: none"> • Network • USB Cable • Card Reader*² • FAX*¹ • Application <p>Value: Off, On</p> <p> NOTE If the sleep condition is not turned off, the machine will not wake from sleep mode even if it receives a print job from a computer connected by USB cable. Also, the ID card cannot be recognized.</p>

Item	Description
Sleep Level (models except for Europe)	Select the sleep level. Set the Energy Saver mode to reduce power consumption even more than normal Sleep mode. Value: Quick Recovery, Energy Saver  NOTE This function will not be displayed when the optional Network Interface Kit is installed.
Sleep Rules	Select whether to use the Energy Saver mode for the following functions individually: <ul style="list-style-type: none"> • Network • USB Cable • Card Reader*² • FAX*¹ • Application Value: Off, On  NOTE When the machine has entered sleep mode with Energy Saver setting, it does not wake from sleep mode when it receives print data from a PC connected by USB cable. Also, the ID card cannot be recognized.
EnergySaver RecoveryLevel	Select the method of recovery from energy saver. Value: Full Recovery: This mode enables the use of all functions immediately. However, this mode saves less energy. Normal Recovery: In this mode, you can select the method from the following: enabling the use of all functions immediately or enabling the use of desired functions only. If you want to use all functions immediately, press the [Power] key to execute recovery. Power Saving Recovery: This mode enables the use of desired functions only. This mode saves energy most effectively.
Weekly Timer Settings	Configure settings for switching the machine into Sleep mode and waking it automatically at a specified time for each day of the week.
Weekly Timer	Select whether to use Weekly Timer. Value: Off, On
Schedule	Specify the time for each day of the week at which the machine enters Sleep mode and recovers.
Retry Times	Set the number of retry to switch the machine into Sleep mode. Value: Limited Retries, Unlimited Retries  NOTE If [Limited Retries] is selected, set the number of retry. The setting range is 0 to 10. Retry is not performed when "0" is set. If [Unlimited Retries] is selected, retry is performed until the machine enters Sleep mode.
Retry Interval	Set the retry interval. Use [-] / [+] to enter a number. Value: 10 to 60 seconds (increments of 10 seconds)

*1 Displayed only when the optional FAX Kit is installed.

*2 This is displayed when the optional Card Authentication Kit is installed.



Adjustment/Maintenance

System Menu









Adjustment/Maintenance

Adjust printing quality and conduct machine maintenance.

Item	Description
Density Adjustment	Adjust density.
Copy	Adjust copy density. Adjustment can be made in 7 levels. Value: -3 (Lighter), -2, -1, 0 (Normal), +1, +2, +3 (Darker)
Send/Box	Adjust scan density when sending or storing the data in Document Box. Adjustment can be made in 7 levels. Value: -3 (Lighter), -2, -1, 0 (Normal), +1, +2, +3 (Darker)
FAX*	For details, refer to the FAX Operation Guide .
Background Density Adj.	Darkens or lightens overall background density adjustment.
Copy (Auto)	Darkens or lightens overall background density adjustment during copying. Adjustment can be made in 7 levels. Value: -3 (Lighter), -2, -1, 0 (Normal), +1, +2, +3 (Darker)
Send/Box (Auto)	Darkens or lightens overall background density when sending images or storing them in the Document Box. Adjustment can be made in 7 levels. Value: -3 (Lighter), -2, -1, 0 (Normal), +1, +2, +3 (Darker)
Correcting Black Lines	Correct fine lines (streaks caused by contamination), which may appear on the image, when the document processor is used. Value Off: No correction performed. On (Low): Correction performed. The reproduction of fine lines on the original may become lighter than when using [Off]. On (High): Select this item if a streak remains after using [On (Low)]. The reproduction of fine lines on the original may become lighter than when using [On (Low)].
System Initialization	Initialize the hard disk installed on the machine to return it to the factory defaults.  NOTE This function will not be displayed when the optional Data Security Kit is activated.
Display Brightness	Set the brightness of the touch panel. Value: 1 (Darker), 2, 3, 4 (Lighter)
Silent Mode	Makes the machine enter a sleep state immediately after printing to reduce operating sound. Enable this setting if you find that the operating sound is unpleasant. Value: Off, On  NOTE When [On] is selected, it may take time for the next print job to start if the ambient temperature is 17°C or less.
Memory Diagnostics	Perform this function to check the machine memory.

* Displayed only when the optional FAX Kit is installed.

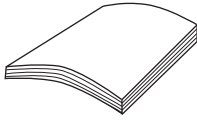
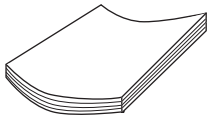
Item	Description
Auto Color Correction	<p>This setting allows you to adjust the detection level used by the machine to determine whether the original is color or black and white in Auto Color Selection Mode. Setting a lower value will result in more originals being identified as color, while a larger value will tend to increase the number of originals being identified as black and white.</p> <p>Value: 1 (Color), 2, 3, 4, 5 (B & W)</p>
Tone Curve Adjustment	<p>After prolonged use, or from the effects of surrounding temperature or humidity, the printed output tone may differ from the original. Perform this function to ensure consistency with the original tone.</p> <p>For the procedure, refer to Tone Curve Adjustment on page 10-36.</p>
Drum Refresh 1	<p>Refresh the drum when image blur appear on printout in copies. Takes about 85 seconds.</p> <p>For more information, refer to the Drum Refresh1 on page 10-37.</p> <p> NOTE</p> <p>Drum Refresh1 cannot be performed while printing. Execute Drum Refresh1 after the printing is done.</p>
Drum Refresh 2	<p>Use this mode when white spots appear on printout. Takes about 85 seconds. To use [Drum Refresh2], load Ledger or A3 size paper into the Multi Purpose tray.</p> <p>When you run [Drum Refresh 2], the machine makes a vibrating sound for about 85 seconds until drum refreshing is completed. The toner soiling on the ejected paper is normal and does not indicate a fault.</p> <p>For more information, refer to the Drum Refresh2 on page 10-37.</p> <p> NOTE</p> <p>Drum Refresh2 cannot be performed while printing. Execute Drum Refresh2 after the printing is done.</p>
Developer Refresh	<p>Adjust the printed image that is too light or incomplete, even though there is enough toner. In addition, Black or color dots appear on the white background when white original is scanned can be removed.</p> <p>For the procedure, refer to Developer Refresh on page 10-38.</p> <p> NOTE</p> <p>Waiting time may be longer when the toner is refilled during developer refresh.</p>
Calibration Cycle	<p>Set the calibration cycle.</p> <p>Value:</p> <p>Short: Priority is given to image quality.</p> <p>Standard: Balances image quality and print speed.</p> <p>Long: Priority is given to print speed.</p> <p> NOTE</p> <p>When [Custom] is displayed as setting item, the setting cannot be changed.</p>

Item	Description
Calibration	<p>Calibrate the device to ensure consistency with the original grayscale. For the procedure, refer to Calibration on page 10-38.</p> <p> NOTE If you find that the grayscale is not improved by this calibration, use Tone Curve Adjustment (page 10-36).</p>
Correct Paper Curl	<p>Some paper types and paper stored in certain conditions may curl. This feature can be used to correct paper curling.</p> <p>Value: Auto, Reduce Downcurl, Reduce Upcurl</p> <div data-bbox="523 555 959 712" style="text-align: center;"><p>Upcurl Downcurl</p></div> <p> NOTE This function is displayed when the optional 1,000-Sheet Finisher or 4,000-Sheet Finisher is installed.</p>

Internet

System Menu  **Internet**

Item	Description
Internet Browser	Select whether to use the Internet browser. Value: Off, On
Browser Environment	This specifies Internet browser preferences such as your home page setting and how pages are displayed. Value: Home page: (Enter the address for Home page.) Text Size: Large, Medium, Small Display Mode: Normal, Just-Fit Rendering, Smart-Fit Rendering Cookie: Accept All, Reject All, Prompt before Accepting  NOTE This is not displayed if [Off] is selected in Internet Browser on page 8-60 .

 **NOTE**

To use proxy from Internet Browser, refer to [Proxy on page 8-47](#) to configure settings.

Application

System Menu  **Application**

Configure application settings.

 [Application \(page 5-10\)](#)

9 User Authentication and Accounting (User Login, Job Accounting)

This chapter explains the following topics:

User Login	9-2
First User Login Administration	9-2
User Login Setting	9-2
User Login	9-4
Authentication Security	9-6
Adding a User (Local User List)	9-8
Changing User Properties	9-11
Local Authorization	9-15
Group Authorization Set.	9-15
Guest Authorization Set.	9-18
Obtain NW User Property	9-21
Simple Login Settings	9-23
ID Card Settings	9-26
Job Accounting Setting	9-27
First Job Accounting Setup	9-27
Job Accounting Setting	9-27
Job Accounting	9-29
Login/Logout	9-29
Job Accounting Access	9-30
Job Accounting (Local)	9-31
Accounting List	9-32
Managing Accounts	9-33
Default Setting	9-36
Counting the Number of Pages Printed	9-38
Apply Limit	9-40
Copier/Printer Count	9-40
Unknown ID Job	9-41

User Login

User login administration specifies how the user access is administered on this machine. Enter a correct login user name and password for user authentication to login.

Access are in three levels - "User", "Administrator", and "Machine Administrator". The security levels can be modified only by the "Machine Administrator".

Users that are not able to log in to the machine can be allowed to use the functions of the machine on a restricted basis. The users can use the machine without performing authentication, and thus this feature is convenient when the majority of users are managed with the same authority. You can prohibit the box store function in "Guest Authorization Set." so that the box store function cannot be used unless the user logs in. If "To use this function, press Authentication key and login" appears while operating the machine, you must press the [[Authentication/Logout](#)] key and log in as a user for whom the function is not prohibited.

When User Login is enabled, a login user name and password must be entered in each driver.

 [Setting TWAIN Driver \(page 2-19\)](#)

[Setting WIA Driver \(page 2-20\)](#)

Printer driver print settings (refer to **Printer Driver User Guide**)

Network FAX driver settings (refer to **FAX Operation Guide**)

First User Login Administration

Follow these steps for the first user login administration.

Enable user login administration. (page 9-4)



Add a user. (page 9-8)



Log out. (page 2-22)



The registered user logs in for operations. (page 9-29)

User Login Setting

1 Display the screen.

- 1 Press the [[System Menu](#)] key.

System Menu



- 2 Press [[↙](#)] and then [User Login/Job Accounting].

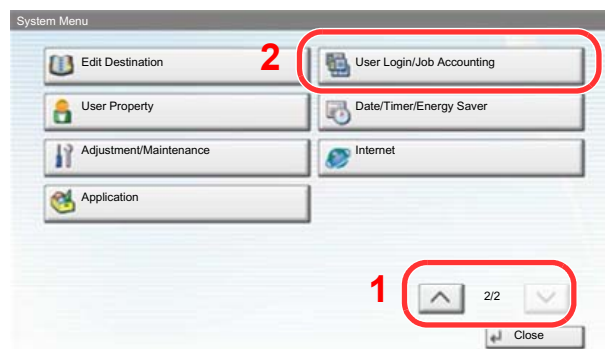



NOTE

If the user authentication screen appears, enter your login user name and login password and press [Login]. For this, you need to login with administrator privileges.

The factory default login user name and login password are set as shown below.

Model Name	Login User Name	Login Password
3501i	3500	3500
4501i	4500	4500
5501i	5500	5500

3 Press [Next] of "User Login Setting".

The user login administration setting screen appears.

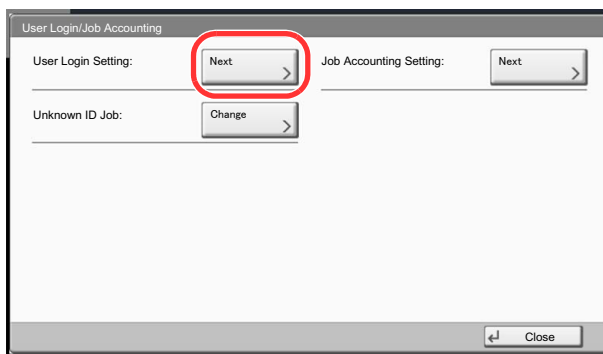

2 Configure the settings.

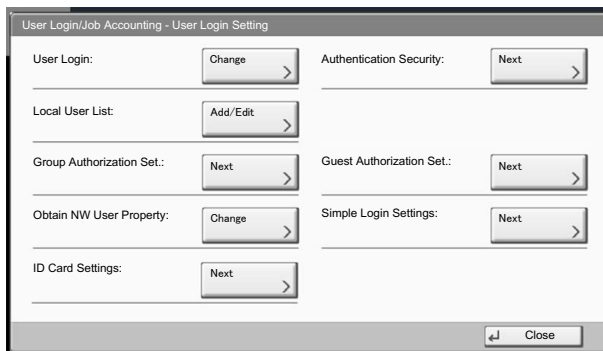

- [User Login \(page 9-4\)](#)
- [Authentication Security \(page 9-6\)](#)
- [Adding a User \(Local User List\) \(page 9-8\)](#)
- [Local Authorization \(page 9-15\)](#)
- [Group Authorization Set. \(page 9-15\)](#)
- [Guest Authorization Set. \(page 9-18\)](#)
- [Obtain NW User Property \(page 9-21\)](#)
- [Simple Login \(page 9-23\)](#)
- [ID Card Settings \(page 9-26\)](#)

User Login

This enables user login administration. Select one of the following authentication methods:

Item	Descriptions
Local Authentication	User authentication based on user properties on the local user list stored in the machine.
Network Authentication	User authentication based on Authentication Server. Use a user property stored in Authentication Server to access the network authentication login page.

1 Display the screen.

- 1 Referring to [User Login Setting on page 9-2](#), display the user login setting screen.
- 2 Press [Change] of "User Login".

2 Configure the settings.

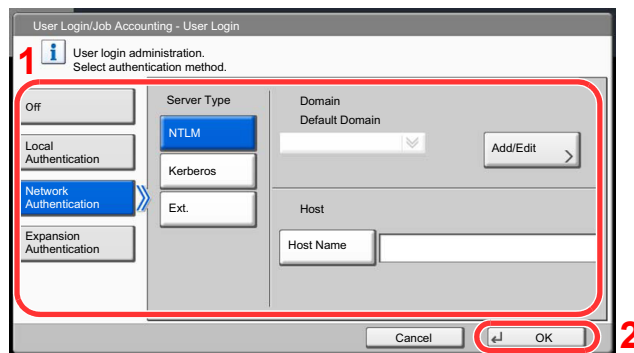

- 1 Select [Local Authentication] or [Network Authentication].

Select [Off] to disable user login administration.

If you select [Network Authentication], enter the host name (64 characters or less) and domain name (256 characters or less) for the Authentication Server. Select [NTLM], [Kerberos] or [Ext.] as the server type.

When selecting [Ext.] as the server type, enter the port number.

NOTE

Pressing [Add/Edit] of "Domain" displays the domain registration list. In the domain registration list screen, press [Add/Edit], and enter the domain name. Up to 10 domain names can be registered.

- 2 Press [OK].

If [Local Authentication] is selected, "Do you want to add a new function to the home screen?" appears when [OK] is pressed.

To add a new function, press [Yes]. The selection screen for functions displayed in the home screen will appear.



[Available Functions to Display on Desktop \(page 3-6\)](#)



NOTE

If the login user name and password are rejected, check the following settings.

- Network Authentication setting of the machine
- User property of the Authentication Server
- Date and time setting of the machine and the Authentication Server

If you cannot login because of the setting of the machine, login with any administrator registered in the local user list and correct the settings.

Up to 10 domains can be registered for network authentication.

Authentication Security

If user authentication is enabled, configure the user authentication settings.

User Account Lockout Set.

Configure these settings to restrict the operation for the user being authenticated.

1 Display the screen.

- 1 Referring to [User Login Setting on page 9-2](#), display the user login setting screen.
- 2 Press [Next] of "Authentication Security" and then [Next] of "User Account Lockout Set."

2 Configure the settings.

The following settings can be selected.

Item	Descriptions
Lockout	Select whether or not account lockout policy is enabled. Value: Off, On
Lockout Policy	Specify the conditions and the extent to which the account lockout is applied. Value Number of Retries until Locked: Specify how many login retries are allowed until the account is locked out. (1 to 10 times) Lockout Duration: Specify how long the account is to be locked out until it is unlocked. (1 to 60 minutes) Lockout Target Specify the extent to which the account lockout is applied. You can select from [All] or [Remote Login Only]. Remote Login Only locks out all operations from outside the operation panel.
Locked out Users List	Displays a list of locked out users. You can unlock a user by selecting the user in the list, and pressing [Unlock].

Password Policy Settings

You can prohibit the setting and use of passwords that do not comply with the password policy.

Setting the Password Policy makes it more difficult to break the password.

1 Display the screen.

- 1 Referring to [User Login Setting on page 9-2](#), display the user login setting screen.
- 2 Press [Next] of "Authentication Security" and then [Next] of "Password Policy Settings".

2 Configure the settings.

The following settings can be selected.

Item	Descriptions
Password Policy	Select whether or not password policy is enabled. Value: Off, On
Minimum password length	Set the minimum password length of characters for password. Value: Off, On (1 to 64 characters)
Password complexity	Set the password complexity. Value No more than two consecutive identical char: Off, On At least one uppercase letter (A-Z): Off, On At least one lowercase letter (a-z): Off, On At least one number (0-9): Off, On At least one symbol: Off, On
Maximum password age	Set the maximum password age. Value: Off, On (1 to 180 days)
Policy Violated User List	List of users do not meet password policy requirements.

Adding a User (Local User List)

This adds a new user. You can add up to 1,000 users (including the default login user name).

 **NOTE**
By default, one of each default user with machine administrator rights and administrator privileges is already stored. Each user's properties are:

Machine Administrator

User Name: DeviceAdmin
Login User Name: 3501i: 3500, 4501i: 4500, 5501i: 5500
Login Password: 3501i: 3500, 4501i: 4500, 5501i: 5500
Access Level: Machine Administrator

Administrator

User Name: Admin
Login User Name: Admin
Login Password: Admin
Access Level: Administrator

* Upper case and lower case letters are distinguished (case sensitive).



It is recommended to periodically change the user name, login user name and login password regularly for your security.

1 Display the screen.

- 1 Referring to [User Login Setting on page 9-2](#), display the user login setting screen.
- 2 Press [Add/Edit] of "Local User List" and then [Add].

2 Enter the user information.

The table below explains the user information to be registered.

Item	Descriptions
User Name*¹	Enter the name displayed on the user list (up to 32 characters).
Login User Name*¹	Enter the login user name to login (up to 64 characters). The same login user name cannot be registered.
Login Password	Enter the password to login (up to 64 characters).
Access Level*¹	Select "Administrator" or "User" for user access privileges.
Account Name	<p>Add an account where the user belongs. The user, who registered his/her account name, can login without entering the account ID. Refer to Job Accounting Setting on page 9-27</p> <p> NOTE</p> <p>Select [Name] or [ID] from the "Sort" to sort the account list.</p> <p>Press [Search(Name)] or [Search(ID)] to search by account name or account ID.</p>
E-mail Address	The user can register his/her E-mail address. The registered address will be automatically selected for subsequent operations that need any E-mail function.
ID Card Information	<p>Register ID card information.</p> <p>Place the ID card on the ID card reader, and press [Read].</p> <p> NOTE</p> <p>This function is displayed when the optional ID Card Authentication Kit is activated.</p> <p> Card Authentication Kit(B) "Card Authentication Kit" (page 11-6)</p>

Item	Descriptions
Local Authorization	<p>Set usage authority for each user. Local Authorization must be enabled. (Refer to page 9-15.)</p> <p>The following restriction items are available:</p> <p>Print Restriction: Select whether or not use of the print function of the printer is prohibited.</p> <p>Copy Restriction: Select whether or not use of the copy print function is prohibited.</p> <p>Duplex Restriction: Select whether only duplex printing is allowed.</p> <p>Combine Restriction: Specify whether only Combine is allowed.</p> <p>EcoPrint Restriction: Specify whether only EcoPrint is allowed.</p> <p>Send Restriction: Select whether or not use of the send function is prohibited.</p> <p>FAX TX Restriction*2: Select whether or not use of the fax send function is prohibited.</p> <p>Storing Restr. in Box: Select whether or not use of the box store function is prohibited.</p> <p>Storing Restr. in Memory: Select whether or not use of the removable memory store function is prohibited.</p>
My Panel	<p>You can register the language selection and initial screen settings for each user.</p> <p>Settings registered here can be applied simply by logging in.</p>

*1 Mandatory at user registration.

*2 Displayed only when the optional FAX Kit is installed.



NOTE

Refer to the [Entering Characters on page 11-12](#) for details on entering characters.

If you selected [Send], select the screen to display from [Destination], [Machine Address Book], or [Ext Address Book].

3 Press [Save].

A new user is added on the local user list.



NOTE

If simple login is enabled, a confirmation screen appears when new registration is finished asking if you will configure simple login settings. To configure simple login settings, press [Yes]. For the procedure for configuring simple login settings, refer to [Simple Login Settings on page 9-23](#). If you select [No], you will return to the user list screen.

Changing User Properties

User properties can be changed. Types of user properties that could be changed may be different depending on user access privilege.

NOTE

To change the user information of the machine administrator, you must log in with machine administrator authority. You can only view user information if you log in as a regular user.

The factory default login user name and login password are set as shown below.

Model Name	Login User Name	Login Password
3501i	3500	3500
4501i	4500	4500
5501i	5500	5500

For a user with administrator rights who logs in

User properties can be changed and users can be deleted. The items, which can be added, are all able to be changed.

1 Display the screen.

- 1 Referring to [User Login Setting on page 9-2](#), display the user login setting screen.
- 2 Press [Add/Edit] of "Local User List".

2 Change the user properties.

- 1 Select the user whose properties you wish to change.

NOTE

Select [Name] and [Login Name] from the "Sort" to sort the user list.

Press [Search(Name)] or [Search(Login)] to search by name or login user name.

- 2 Change the user properties.

Changing user properties

- 1 Press [Detail].
- 2 Refer to step 2 of Adding a User to change a user property.

The screenshot shows a 'User' property change interface. It has two columns of fields. The left column includes: User Name (01 User), Login User Name (0099), Access Level (User), E-mail Address (abcd@efg.com), and Local Authorization (Next). The right column includes: Login Password (*****), Account Name (02Account), ID Card Information (Empty), and My Panel (Next). Each field has a corresponding button: 'Change' for most and 'Next' for Local Authorization and My Panel. Two vertical columns of 'Change' buttons are circled in red.

- 3 Press [Save].
- 4 Press [Yes] in the registration confirmation screen.
The user information is changed.

Deleting a user

- 1 Press [Delete].
- 2 Press [Yes] in the deletion confirmation screen.
The selected user will be deleted.



NOTE

The default user with administrator rights cannot be deleted.

To change the user information of logged in user (User Property)

These users can partially change their own user properties including user name, login password, and E-mail address. Although "Login User Name", "Access Level", or "Account Name" cannot be changed, the users can check the present status.

1 Display the screen.

- 1 Press the [System Menu] key.

System Menu









- 2 Press [✓] and then [User Property].

2 Change the user properties.

- 1 Refer to step 2 of Adding a User to change a user property.

Press [Detail] of "Login User Name" or "Account Name" to check the present status.

Item	Description
User Name	Changes the name shown on the user list. Up to 32 characters can be entered.
Login User Name	Displays the login user name that is entered at login.
Login Password	Changes the password that is entered at login. Up to 64 characters can be entered.
Access Level	Displays the user's access level.
Maximum Password Age	Displays the term of validity of the login password.  NOTE This function does not appear when Password Policy is set to [Off] or the term of validity of the password is set to [Off].
E-mail Address	Changes the user's e-mail address. Up to 128 characters can be entered.  NOTE This function appears when Local Authorization is set to [On], Group Authorization is set to [On], and Guest Authorization Setting is set to [On].
Authorization Rules	Displays the usage restriction that is set for the logged in user.  NOTE [Job Accounting Rules] shows the account name set for the logged in user and the usage restrictions that are set for that account. This function appears when job accounting is set to [On]. For information on job accounting, refer to Job Accounting Setting (page 9-27) .
Simple Login	When simple login is enabled, changes associated settings.  NOTE This function does not appear when Simple Login is set to [Off] or the user is not registered in Simple Login.

Item	Description
ID Card Information	<p data-bbox="687 212 1262 241">Displays the ID card information of the logged in user.</p> <p data-bbox="687 264 820 293"> NOTE</p> <p data-bbox="687 315 1453 367">This function is displayed when the optional ID Card Authentication Kit is activated.</p> <p data-bbox="687 389 1426 418"> Card Authentication Kit(B) "Card Authentication Kit" (page 11-6)</p> <p data-bbox="687 456 1481 539">This function does not appear when the server type is set to [Ext.] in Network Authentication, and logged in with the user account certificated in the server specified as the [Ext.] server type.</p>
My Panel	<p data-bbox="687 564 1485 622">Register the language and default screen for each user. Once registered, the setting will be applied simply by login. Network users are not displayed.</p>

2 Press [Save].

The user information is changed.

Local Authorization

Select whether or not to use Local Authorization.



NOTE

When using Local Authorization, the user authentication type must be set to [Local Authentication].

For details, refer to [User Login on page 9-4](#).

1 Display the screen.

- 1 Referring to [User Login Setting on page 9-2](#), display the user login setting screen.
- 2 Press [Change] of "Local Authorization".

2 Configure the setting.

- 1 Select [Off] or [On].
- 2 Press [OK].

Group Authorization Set.

Set restrictions of the machine usage by each individual group registered in the authentication server.



NOTE

To use the group authorization settings, [Network Authentication] must be selected for the authentication method in [User Login on page 9-4](#). Select "On" for "LDAP" in [Protocol Settings on page 8-45](#).

Group Authorization

Use the group authorization.

1 Display the screen.

- 1 Referring to [User Login Setting on page 9-2](#), display the user login setting screen.
- 2 Press [Next] of "Group Authorization Set.", and then [Change] of "Group Authorization".

2 Configure the setting.

- 1 Press [On].
- 2 Press [OK].

Group List

Register the groups that are restricted the machine usage. Up to 20 groups can be individually registered. Other users and groups belong to "Others".

The table below explains the group information to be registered.

Item	Descriptions
Group ID*¹	Enter the ID displayed on the group list (between 1 and 4294967295).
Group Name	Enter the name displayed on the group list (up to 32 characters).
Access Level	Select [Administrator] or [User] for group access privileges.
Print Restriction	Select whether or not to reject usage of print functions for the printer.
Copy Restriction	Select whether or not to reject usage of copy functions.
Duplex Restriction	Select whether only duplex printing is allowed.
Combine Restriction	Specify whether only Combine is allowed.
EcoPrint Restriction	Specify whether only EcoPrint is allowed.
Send Restriction	Select whether or not to reject usage of the send functions.
FAX TX Restriction*²	Select whether or not to reject usage of the FAX transmissions.
Storing Restr. in Box	Select whether or not to reject usage of storing in the document boxes.
Storing Restr. in Memory	Select whether or not to reject usage of storing in the removable memory.

*1 For "Group ID", specify PrimaryGroupID assigned by Active Directory of Windows. If you are using Windows Server 2008, check Attribute Editor tab of user properties. If you are using Windows Server 2000/2003, check ADSIEdit. ADSIEdit is a support tool included on the installation DVD for Windows Server OS (under \SUPPORT\TOOLS).

*2 These items are displayed when the optional FAX Kit is installed.

1 Display the screen.

- 1 Referring to [User Login Setting on page 9-2](#), display the user login setting screen.
- 2 Press [Next] of "Group Authorization Set.", [Next] of "Group List" and then [Add].

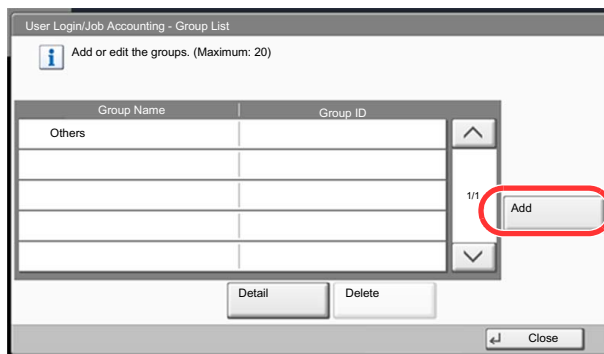

2 Configure the settings.

The screenshot shows a 'Group' configuration window. It has a title bar 'Group:' and a close button. The window contains four fields: 'Group ID:', 'Group Name:', 'Access Level:', and 'Print Restriction:'. Each field has a 'Change' button with a right-pointing arrow. Below 'Print Restriction:' is a 'Copy Restriction:' field with a 'Change' button. At the bottom, there are 'Cancel' and 'Save' buttons, and a page indicator '1/2' with up and down arrows.

- 1 Press [Change] of "Group ID".
- 2 Enter the group ID and press [OK].
- 3 Press [Change] of "Group Name".
- 4 Enter the group name and press [OK].



NOTE

Refer to [Entering Characters on page 11-12](#) for details on entering characters.

- 5 Press [Change] of "Access Level".
- 6 Select the group access privileges and press [OK].
- 7 Press [Change] of "Print Restriction".
- 8 Select [Reject Usage] or [Off] and press [OK].
- 9 Similar to steps 7 and 8, set "Copy Restriction", "Duplex Restriction", "Combine Restriction", "EcoPrint Restriction", "Send Restriction", "Fax TX Restriction", "Storing Restr. in Box", and "Storing Restr. in Memory".

3 Register the group.

Press [Save]. A new group is added on the group list.

Guest Authorization Set.

When User Login Administration is enabled, set the functions that guest users who cannot log in to the machine are allowed to use.

NOTE

To use Guest Authorization Set., User Login Administration must be enabled in [User Login on page 9-4](#). Cannot be used when the Key Counter option is used.

Guest Authorization

Use the guest authorization.

1 Display the screen.

- 1 Referring to [User Login Setting on page 9-2](#), display the user login setting screen.
- 2 Press [Next] of "Guest Authorization Set.", and then [Change] of "Guest Authorization".

2 Configure the setting.

- 1 Select [On] or [Off].
- 2 Press [OK].

NOTE

If the guest authentication setting is enabled, the [\[Authentication/Logout\]](#) key must be pressed when logging in.

In the guest user default settings, only monochrome copying can be used. If you wish to use a different function, log in as a user who can use that function, or change the settings in the guest properties.

Guest Property

Register guest user information and functions that are restricted.

The table below explains the user information to be registered.

Item	Descriptions
User Name	Enter the name displayed on the user list (up to 32 characters). The default setting is "Guest User".
Access Level	The authority of the user appears. This cannot be changed.
Account Name	Add an account where the user belongs. If the user does not belong to any account, select [Other Account].

Item	Descriptions
Authorization Rules	<p>Set usage authority for each user. The items you can restrict the access level with are as follows.</p> <p>Print Restriction: Select whether or not use of the print function of the printer is prohibited.</p> <p>Copy Restriction: Select whether or not use of the copy print function is prohibited.</p> <p>Duplex Restriction: Select whether only duplex printing is allowed.</p> <p>Combine Restriction: Specify whether only Combine is allowed.</p> <p>EcoPrint Restriction: Specify whether only EcoPrint is allowed.</p> <p>Send Restriction: Select whether or not use of the send function is prohibited.</p> <p>FAX TX Restriction*: Select whether or not use of the fax send function is prohibited.</p> <p>Storing Restr. in Box: Select whether or not use of the box store function is prohibited.</p> <p>Storing Restr. in Memory: Select whether or not use of the removable memory store function is prohibited.</p>

* These items are displayed when the optional FAX Kit is installed.

1 Display the screen.

- 1 Referring to [User Login Setting on page 9-2](#), display the user login setting screen.
- 2 Press [Next] of "Guest Authorization Set.", and then [Change] of "Guest Property".

2 Configure the settings.

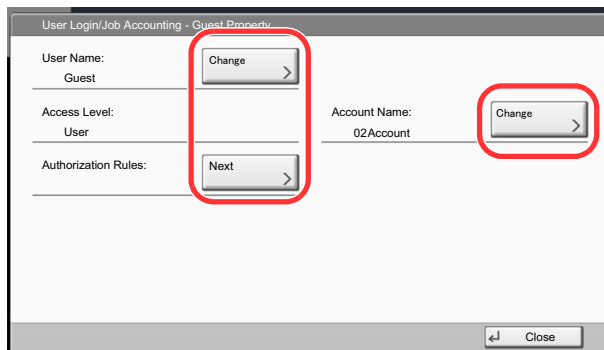

- 1 Press [Change] of "User Name".
- 2 Enter the user name and press [OK].



NOTE

Refer to the [Entering Characters on page 11-12](#) for details on entering characters.

- 3 Press [Change] of "Account Name".
- 4 Select the account and press [OK].



NOTE

Select [Name] or [ID] from the "Sort" to sort the account list.

Press [Search(Name)] or [Search(ID)] to search by account name or account ID.

- 5 Press [Next] of "Authorization Rules".
- 6 Press [Change] of "Print Restriction".
- 7 Select [Reject Usage] or [Off] and press [OK].
- 8 Repeat steps 7 and 8, set "Copy Restriction", "Duplex Restriction", "Combine Restriction", "EcoPrint Restriction", "Send Restriction", "Fax TX Restriction", "Storing Restr. in Box", and "Storing Restr. in Memory".
- 9 Press [Close].

3 Register the guest property.

Press [Save].

Obtain NW User Property

Set the required information to obtain the network user property from the LDAP server. The user name and E-mail address obtained with this setting is shown in the user information, the status confirmation screen, and the header of E-mail.



NOTE

To obtain the network user property from the LDAP server, [Network Authentication] must be selected for the authentication method in [User Login on page 9-4](#). Select "On" for "LDAP" in [Protocol Settings on page 8-45](#).

The table below explains the required information to be registered.

Item	Descriptions
Server Name*¹	Enter the LDAP server name or the IP address (up to 64 characters). If a server name is not entered, user information will be acquired from the server set for Network Authentication.
Port	Set the LDAP port number or use the default port 389.
Name 1*²	Enter the LDAP Attribute to obtain the user name to be displayed from the LDAP server (up to 32 characters).
Name 2*³	Enter the LDAP Attribute to obtain the user name to be displayed from the LDAP server (up to 32 characters).
E-mail Address*⁴	Enter the LDAP Attribute to obtain the E-mail address from the LDAP server (up to 32 characters).
Authentic at Type*⁵	Set the authentication method. Select [Simple] or [SASL]. After changing the setting, restart the system or turn the power off and then on.
Search Timeout	Set the amount of time to wait before time-out in seconds (from 5 to 255 seconds).
LDAP Security	Select the type of encryption according to the type of security employed by the LDAP server. The value is [Off], [SSL/TLS] or [STARTTLS].

*1 If using Active Directory of Windows, the server name may be the same as the server name entered in the network authentication.

*2 If using Active Directory of Windows, displayName of Attribute may be used as "Name 1".

*3 "Name 2" can be left out. When you assign displayName in "Name 1" and department in "Name 2", and if the value of displayName is "Mike Smith" and the value of department is "Sales" in Active Directory of Windows, the user name appears as "Mike Smith Sales".

*4 If using Active Directory of Windows, mail of Attribute may be used as E-mail Address.

*5 Appears when the server type is set to "Kerberos" in "Network Authentication".

1 Display the screen.

- 1 Referring to [User Login Setting on page 9-2](#), display the user login setting screen.
- 2 Press [Change] of "Obtain Network User Property".

2 Configure the settings.

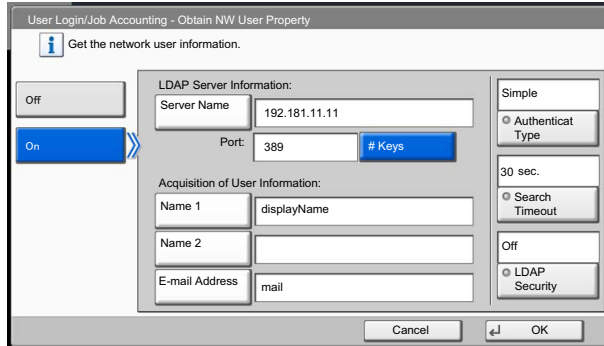

- 1 Press [On].
- 2 Press [Server Name].
- 3 Enter the LDAP server name or the IP address and press [OK].
- 4 Press [# Keys] to enter the LDAP port number using the numeric keys.
- 5 Press [Name 1].
- 6 Enter the LDAP Attribute to obtain the user name to be displayed and press [OK].
- 7 Similar to steps 5 and 6, set [Name 2].
- 8 Press [E-mail Address].
- 9 Enter the LDAP Attribute to obtain the E-mail address and press [OK].
- 10 If you set the server type to "Kerberos", press [Authentication Type] and set the authentication method.
- 11 Press [Search Timeout] to set the amount of time to wait before time-out.
- 12 Press [+], [-] or the numeric keys to enter the time and press [OK].
- 13 Press [LDAP Security] to select the type of encryption according to the type of security employed by the LDAP server.
- 14 Select [Off], [SSL/TLS], or [STARTTLS] and press [OK].

Simple Login Settings

The simple login function allows users to log in simply by selecting a user name. Users must be registered in advance to use this functionality.

NOTE

For user registration, refer to [Adding a User \(Local User List\) on page 9-8](#).
To use Simple Login, User Login Administration must be enabled in [User Login on page 9-4](#).
If the guest authentication setting is enabled, Simple login cannot be enabled.

Simple Login

Select whether or not simple login is enabled.

1 Display the screen.

- 1 Referring to [User Login Setting on page 9-2](#), display the user login setting screen.
- 2 Press [Next] of "Simple Login Settings", and then [Change] of "Simple Login".

2 Configure the setting.

- 1 Select [On] or [Off].
- 2 Press [OK].

Simple Login Key

Register users to use simple login. You can add up to 20 users.

1 Display the screen.

- 1 Referring to [User Login Setting on page 9-2](#), display the user login setting screen.
- 2 Press [Next] of "Simple Login Settings", and then [Next] of "Simple Login Key".

2 Enter the user information.

- 1 Press the key to which you want to register a user.
- 2 Press [Add/Edit].

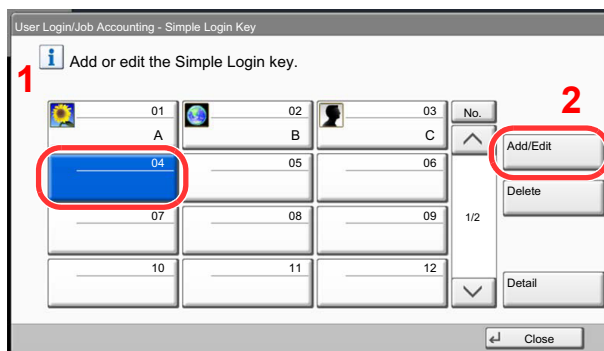

The screenshot shows a window titled "User Login/Job Accounting - Simple Login Key". The main area contains a grid of 12 input fields, numbered 01 to 12, arranged in 4 rows and 3 columns. The first field (01) is highlighted with a red circle and labeled '1'. The 'Add/Edit' button on the right side of the grid is also highlighted with a red circle and labeled '2'. The screen includes a 'Close' button at the bottom right.

- 3 Press [Change] in "Display Name", enter the user name to be displayed, and press [OK].

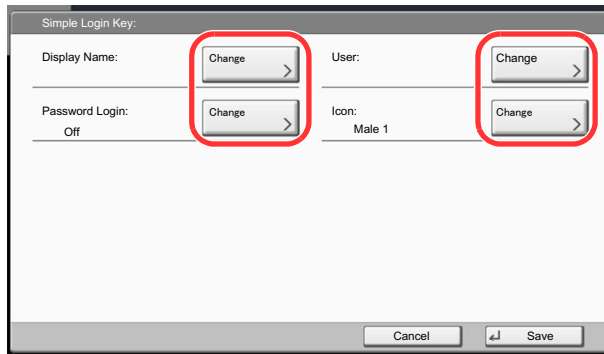

NOTE

Refer to [Entering Characters on page 11-12](#) for details on entering characters.

- 4 Press [Change] of "User".
- 5 To specify the user from local users, select [Local User]. To specify from network users, select [Network User]. Press [Next].

The procedure differs depending on the transmission method selected.

Specifying the user from local users

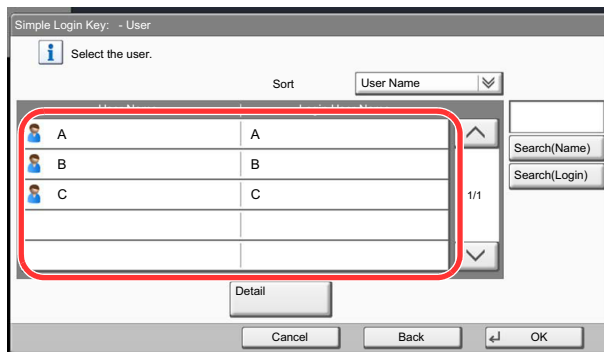

	Sort	User Name
A		A
B		B
C		C

Select the user to be set for simple login.



NOTE

Destinations can be sorted or searched by destination name or address number. For details, refer to [Specifying Destination on page 5-26](#).

Specifying the user from network users

Press [Login User Name] and [Login Password], enter the information of the user to be registered, and press [OK].
If you are specifying a user for whom a domain is set in network authentication, press the "Domain" and select the domain where the user is registered.



NOTE

Refer to [Entering Characters on page 11-12](#) for details on entering characters.

- 5 Press [Change] of "Password Login".
- 6 Press [On] or [Off] and then press [OK].
- 7 Press [Change] of "Icon".
- 8 Select the user icon to be displayed and press [OK].

3 Register the user.

Press [Save].

ID Card Settings

If ID card authentication is enabled, select the authentication type.



NOTE

This function appears when the Card Authentication kit is activated.



[Card Authentication Kit\(B\) "Card Authentication Kit" on page 11-6](#)

This function does not appear when the user logs in as a network authentication user.

1 Display the screen.

- 1 Referring to [User Login Setting on page 9-2](#), display the user login setting screen.
- 2 Press [Next] of "User Login Setting", and then [Next] of "ID Card Settings".

2 Configure the settings.

The following settings can be selected.

Item	Descriptions
Keyboard Login	When ID card authentication is enabled, select whether or not login by keyboard is allowed. Value: Prohibit, Permit
Password Login	Select whether or not to require password entry after authenticating by ID card. Value: Off, On

Job Accounting Setting

Job accounting manages the copy/print count accumulated by individual accounts by assigning an ID to each account. Job accounting helps the following activities in business organizations.

- Manageability of up to 1,000 individual accounts.
- Availability for account IDs with as many as eight digits (between 0 and 99999999) for security.
- Integrated management of printing and scanning statistics through the use of an identical account ID.
- Tracking the print volume for each account and for all accounts combined.
- Restricting the print counter in one-page increments up to 9,999,999 copies.
- Resetting the print counter for each account or for all accounts combined.

When Job Accounting is enabled, an account ID must be entered in each driver.

 [Setting TWAIN Driver \(page 2-19\)](#)

[Setting WIA Driver \(page 2-20\)](#)

Printer driver print settings (refer to **Printer Driver User Guide**)

Network FAX driver settings (refer to **FAX Operation Guide**)

First Job Accounting Setup

Follow these steps for the first job accounting setup.

Enable job accounting. (page 9-29)



Add an account. (page 9-32)



Log out. (page 2-22)



Other users login for operations. (page 9-29)

Job Accounting Setting

1 Display the screen.

- 1 Press the [System Menu] key.

System Menu



- 2 Press [∨] and then [User Login/Job Accounting].

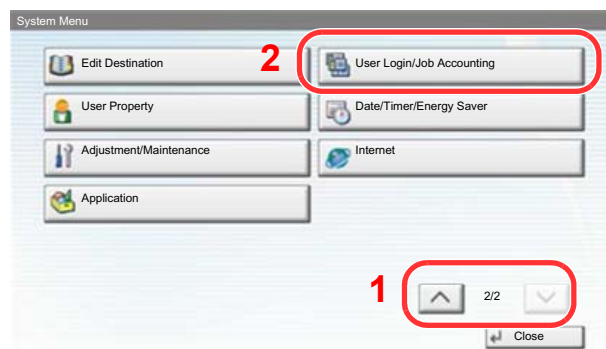



NOTE

If the user authentication screen appears, enter your login user name and login password and press [Login]. For this, you need to login with administrator privileges.

The factory default login user name and login password are set as shown below.

Model Name	Login User Name	Login Password
3501i	3500	3500
4501i	4500	4500
5501i	5500	5500

3 Press [Next] of "Job Accounting Setting".

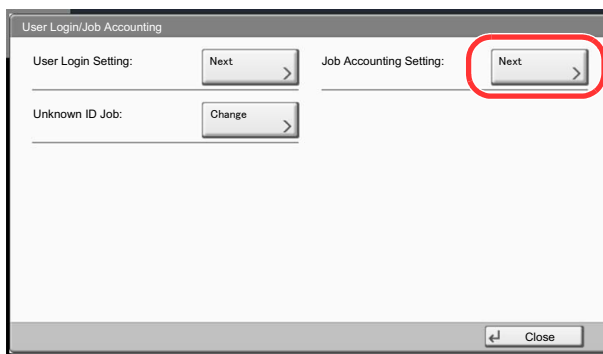

2 Configure the settings.

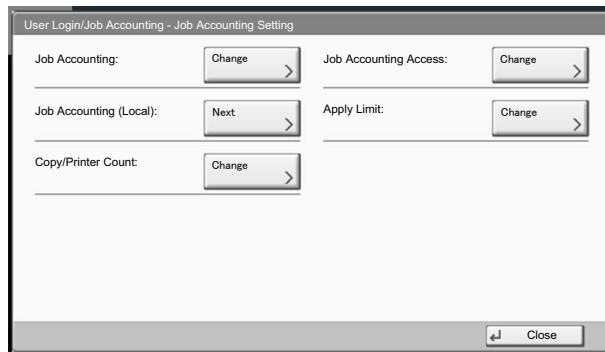

- [Job Accounting \(page 9-29\)](#)
- [Job Accounting Access \(page 9-30\)](#)
- [Job Accounting \(Local\) \(page 9-31\)](#)
- [Apply Limit \(page 9-40\)](#)
- [Copier/Printer Count \(page 9-40\)](#)

Job Accounting

Enable job accounting. Use the procedure below.

1 Display the screen.

- 1 Referring to [Job Accounting Setting on page 9-27](#), display the job accounting access screen.
- 2 Press [Change] of "Job Accounting".

2 Configure the settings.

- 1 Press [On].
To disable job accounting, press [Off].
- 2 Press [OK].



NOTE

When the display returns to System Menu default screen, logout is automatically executed and the screen to enter the Account ID appears. To continue the operation, enter the Account ID.

Login/Logout

If job accounting is enabled, an account ID entry screen appears each time you use this machine.

Use the procedure below to login and logout.

Login

- 1 In the screen below, enter the account ID using the numeric keys and press [Login].

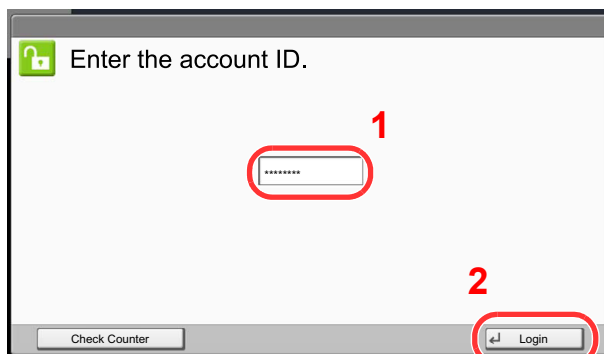

NOTE

If you entered a wrong character, press the [Clear] key and enter the account ID again.

If the entered account ID does not match the registered ID, a warning beep will sound and login will fail. Enter the correct account ID.

By pressing [Check Counter], you can refer to the number of pages printed and the number of pages scanned.

When the screen to enter the login user name and password appears

If user login administration is enabled, the screen to enter the login user name and password appears. Enter a login user name and password to login. (Refer to [Adding a User \(Local User List\) on page 9-8.](#)) If the user has already registered the account information, the account ID entry would be skipped. (Refer to [Adding a User \(Local User List\) on page 9-8.](#))

- 2 Proceed to complete the rest of the steps.

Logout

When the operations are complete, press the [**Authentication/Logout**] key to return to the account ID entry screen.

Authentication/
Logout



Job Accounting Access

Set the job accounting access.

1 Display the screen.

- 1 Referring to [Job Accounting Setting on page 9-27](#), display the job accounting access screen.
- 2 Press [Change] of "Job Accounting Rules".

2 Configure the settings.

Select [Local] or [Network] and press [OK].



NOTE

To select [Network], network authentication must be enabled and [Ext.] must be selected for server type.



[User Login \(page 9-4\)](#)

Job Accounting (Local)

Perform job accounting, such as printing counts and reports for each account.

Print Accounting Report

The total pages counted of all relevant accounts can be printed as an accounting report.

Reports have different formats depending on how the count of copiers and printers is administered.

When "Individual" is selected for Managing the Copy/Printer Count

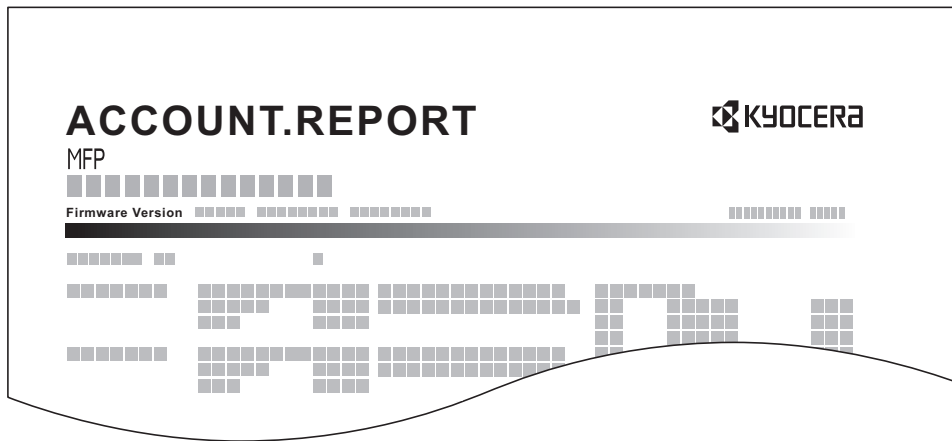

For the count by paper size, the report will be printed by size.

Use the procedure below to print a job accounting report.

1 Prepare paper.

Check that A4 or Letter paper is loaded in the cassette.

2 Display the screen.

- 1 Referring to [Job Accounting Setting on page 9-27](#), display the job accounting access screen.
- 2 Press [Next] of "Job Accounting (Local)".

3 Print the report.

- 1 Press [Print] of "Print Accounting Report".
- 2 Press [Yes] on the screen to confirm the printing.
Accounting report is printed.

Accounting List

Adding an Account

Manage accounts.

Item	Descriptions
Account Name	Enter the account name (up to 32 characters).
Account ID	Enter the account ID as many as eight digits (between 0 and 99999999).
Restriction	This prohibits printing/scanning or restricts the number of sheets to load. Refer to Restricting the Use of the Machine on page 9-34 .

1 Display the screen.

- 1 Referring to [Job Accounting Setting on page 9-27](#), display the job accounting access screen.
- 2 Press [Next] of "Job Accounting (Local)", [Add/Edit] of "Accounting List", and then [Add].

2 Enter the account information.

- 1 Press [Change] of "Account Name".
- 2 Enter the account name and press [OK].
The "Account" screen reappears.



NOTE

Refer to [Entering Characters on page 11-12](#) for details on entering characters.

- 3 Similar to steps 1 and 2, enter the "Account ID".



NOTE

Any "Account ID" that has already registered cannot be used. Enter any other account ID.

- 4 Activate or deactivate restriction.



Refer to [Restricting the Use of the Machine on page 9-34](#).

- 5 Press [Save].

A new account is added on the Account List.

Managing Accounts

This changes the registered account information or deletes the account.

1 Display the screen.

- 1 Referring to [Job Accounting Setting on page 9-27](#), display the job accounting access screen.
- 2 Press [Next] of "Job Accounting (Local)", and then [Add/Edit] of "Accounting List".

2 Edit an account.

- 1 Select an account to change or delete.

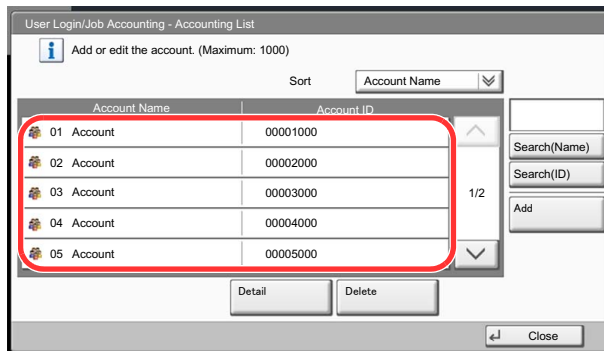

NOTE

Select [Name] or [ID] from the "Sort" to sort the account names.

Press [Search(Name)] or [Search(ID)] to search by account name or account ID.

The procedure differs depending on the details to be edited.

Changing account information

- 2 Press [Detail].
- 3 Refer to step 2 of Adding an Account and step 2 of Restricting Using the Machine to change account information.

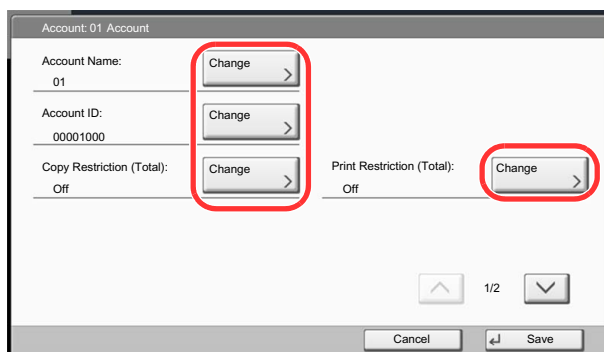

- 4 Press [Save].
- 5 Press [Yes] in the registration confirmation screen.
The account information is changed.

Deleting an account

- 2 Press [Delete].
- 3 Press [Yes] in the deletion confirmation screen.

The account is deleted.

Restricting the Use of the Machine

This section explains how to restrict the use of the machine by account or the number of sheets available.

The items that can be restricted differ depending on whether "Individual" or "Total" is selected for [Copier/Printer Count on page 9-40](#).

Restriction Items

"Individual" selected for Copy/Printer Count

Item	Descriptions
Copy Restriction (Total)	Limits the number of sheets used for copying.
Print Restriction (Total)	Limits the number of sheets used for printing.
Scan Restriction (Others)	Limits the number of sheets scanned (excludes copying).
FAX TX Restriction	Limits the number of sheets sent by fax. This is displayed when the optional FAX Kit is installed.
FAX Port Restriction	Restricts the ports used for faxing. This is displayed when two optional FAX Kits are installed.

"Total" selected for Copy/Printer Count

Item	Descriptions
Print Restriction (Total)	Limits the total number of sheets used for copying and printing.
Scan Restriction (Others)	Limits the number of sheets scanned (excludes copying).
FAX TX Restriction	Limits the number of sheets sent by fax. This is displayed when the optional FAX Kit is installed.
FAX Port Restriction	Restricts the ports used for faxing. This is displayed when two optional FAX Kits are installed.



IMPORTANT

Select [Off], [Use Port 1 Only] or [Use Port 2 Only] as the "FAX Port Restriction" setting.

Applying Restriction

Restriction can be applied in the following modes:

Item	Descriptions
Off	No restriction is applied.
Counter Limit	Restricts the print counter in one-page increments up to 9,999,999 copies.
Reject Usage	Restriction is applied.

1 Display the screen.

- 1 Referring to [Adding an Account on page 9-32](#), display the screen to add an account.
- 2 Press [Change] for the item to be restricted.

2 Configure the settings.

- 1 Select the restriction mode.

If [Counter Limit] is selected, press [+], [-] or numeric keys to enter the number of pages.

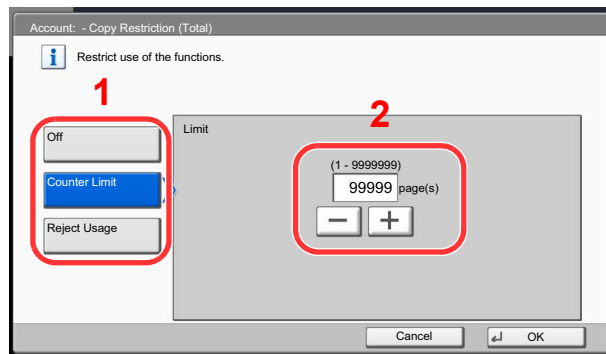

- 2 Press [OK].
 - 3 Repeat steps 1 and 2 for other accounts to be restricted.
 - 4 Press [Save].
- The restricted account is added.

Default Setting

Select the default value for usage limit, and whether or not to enable counting by paper size.

Default Counter Limit

When you add a new account, you can change the default restrictions on the number of sheets used. You can set any number from 1 to 9,999,999.

The items that can be set differ depending on whether "Individual" or "Total" is selected for [Copier/Printer Count on page 9-40](#).

Available Settings

"Individual" selected for Copy/Printer Count

Item	Descriptions
Copy Restriction (Total)	Sets the default restriction on the number of sheets used for copying.
Print Restriction (Total)	Sets the default restriction on the number of sheets used for printing.
Scan Restriction (Others)	Sets the default restriction on the number of sheets used for scanning (excludes copying).
FAX TX Restriction	Sets the default restriction on the number of sheets used for sending faxes. This is displayed when the optional FAX Kit is installed.

"Total" selected for Copy/Printer Count

Item	Descriptions
Print Restriction (Total)	Sets the default restriction on the total number of sheets used for copying and printing.
Scan Restriction (Others)	Sets the default restriction on the number of sheets used for scanning (excludes copying).
FAX TX Restriction	Sets the default restriction on the number of sheets used for sending faxes. This is displayed when the optional FAX Kit is installed.

1 Display the screen.

- 1 Referring to [Job Accounting Setting on page 9-27](#), display the job accounting access screen.
- 2 Press [Next] of "Job Accounting (Local)", [Next] of "Default Setting" and then [Next] of "Default Counter Limit".

2 Configure the settings.

- 1 Press [Change] for the item you want to modify and then press [+], [-] or use the numeric keys to enter the default restriction on the number of sheets.
- 2 Press [OK].

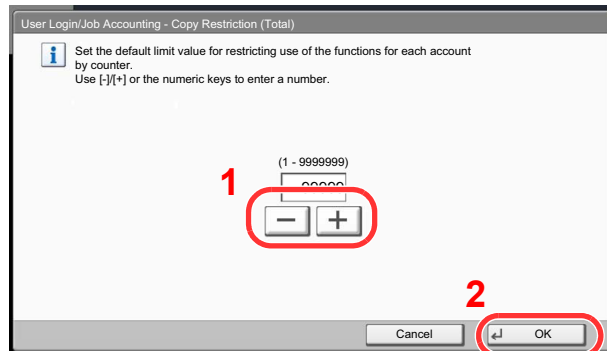

- 3 To set another default restriction, repeat steps 1 and 2.

Count by Paper Size

This counts the number of pages by paper size (e.g. Letter).

NOTE

Paper size is available in five types, 1 to 5. These types are specified in accounting reports. Refer to [Print Accounting Report on page 9-31](#).

In addition to paper size, media type can also be specified (e.g. count the letter-size color paper used). If you do not specify the media type, the number of used sheets will be counted for the specified sheet size, regardless of the media type.

1 Display the screen.

- 1 Referring to [Job Accounting Setting on page 9-27](#), display the job accounting access screen.
- 2 Press [Next] of "Job Accounting (Local)", [Next] of "Default Setting", [Next] of "Count by Paper Size", [Change] of Paper Size 1 to 5.

2 Configure the settings.

- 1 Press [On].
- 2 Select the paper size.
- 3 Press [Media Type] to specify media type.

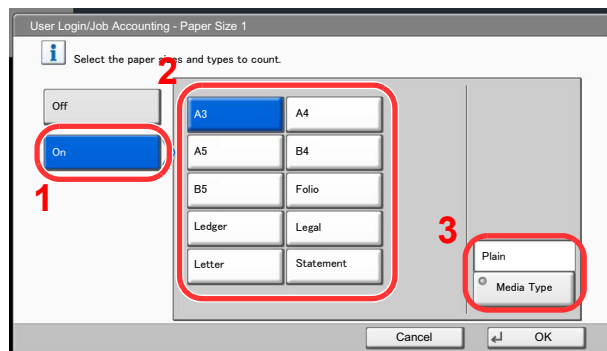

- 4 Select the media type and press [OK].
- 5 Press [OK].

Counting the Number of Pages Printed

This counts the number of pages printed. Counts are classified into Total Job Accounting and Each Job Accounting. A new count can also be started after resetting the count data which was stored for a certain period of time.

Types of the counts are as follows.

Item	Descriptions
Printed Pages	<p>Displays the number of pages copied and printed, and the total number of pages used. You can also use "Count by Paper Size" and "Count by Duplex/Combine" to check the number of pages used.</p> <ul style="list-style-type: none"> You can use "Count by Paper Size" to check the number of pages used in the paper size set in Count by Paper Size on page 9-37 as well as the number of pages used in other paper sizes. You can use the "Count by Duplex/Combine" to check the number of pages used in Duplex (1-sided) mode, Duplex (2-sided) mode and the total for both, as well as the pages used in Combine (None) mode, Combine (2 in 1) mode, Combine (4 in 1) mode and the total for all three.
Scanned Pages	Displays the number of pages scanned for copying, faxing and other functions, as well as the total number of pages scanned.
FAX Transmission Pages	Displays the number of pages faxed.
FAX Transmission Time	Displays the total duration of fax transmissions.

Total Job Accounting

This counts the number of pages for all accounts and resets the counts for those accounts together at the same time.

1 Display the screen.

- Referring to [Job Accounting Setting on page 9-27](#), display the job accounting access screen.
- Press [Next] of "Job Accounting (Local)", and then [Next] of "Total Job Accounting".

2 Check the number of pages.

- Press [Check] at the function to check the count.

The results will be displayed.

Confirm the count and press [Close].

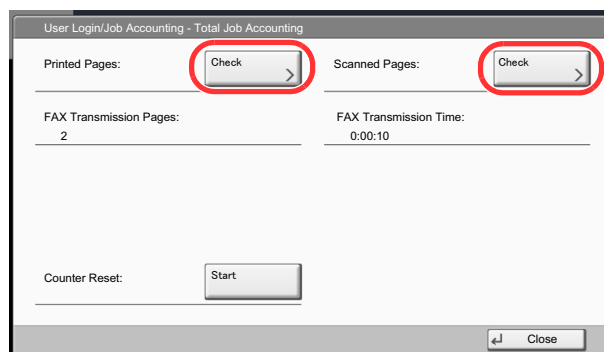

- Press [Start] of "Counter Reset" to reset the counter.
- Press [Yes] in the confirmation screen.
The counter will be reset.

Each Job Accounting

This counts the number of pages for each account and resets the counts by account.

1 Display the screen.

- 1 Referring to [Job Accounting Setting on page 9-27](#), display the job accounting access screen.
- 2 Press [Next] of "Job Accounting (Local)", and then [Check] of "Each Job Accounting".

2 Check the number of pages.

- 1 Select the account to check the count.
- 2 Press [Detail].

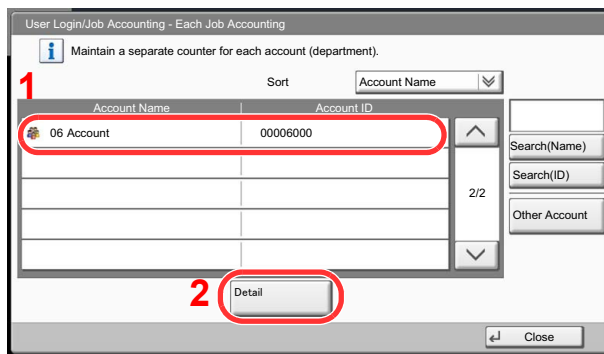

NOTE

Select [Name] or [ID] from the "Sort" to sort the account names.
 Press [Search(Name)] or [Search(ID)] to search by account name or account ID.
 To display an account other than your own account, press [Other Account].

- 3 Press [Check] at the function to check the count.
 The results will be displayed.
 Confirm the count and press [Close].

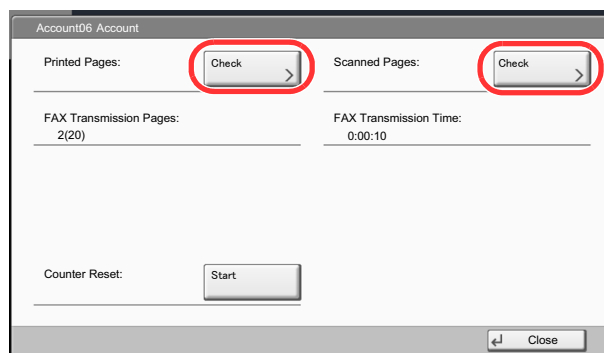

- 4 Press [Start] of "Counter Reset" to reset the counter.
- 5 Press [Yes] in the confirmation screen.
 The counter will be reset.

Apply Limit

This specifies how the machine behaves when the counter has reached the limit of restriction. The table below describes the action taken.

Item	Descriptions
Immediately*	Job stops when the counter reaches its limit.
Subsequently	Printing/scanning of the job continues but the subsequent job will be rejected.
Alert Only	Job continues while displaying an alert message.

* The next job will be prohibited in sending or in storing in the box.

1 Display the screen.

- 1 Referring to [Job Accounting Setting on page 9-27](#), display the job accounting access screen.
- 2 Press [Change] of "Apply Limit".

2 Configure the settings.

- 1 Select [Immediately], [Subsequently], or [Alert Only].
- 2 Press [OK].

Copier/Printer Count

You can select how the copying and printing page counts are shown - either the total of both or each of copying and printing individually. The selection may influence restriction on the count and count method. For details, refer to [Restricting the Use of the Machine \(page 9-34\)](#), [Counting the Number of Pages Printed \(page 9-38\)](#), and [Print Accounting Report \(page 9-31\)](#).

1 Display the screen.

- 1 Referring to [Job Accounting Setting on page 9-27](#), display the job accounting access screen.
- 2 Press [Change] of "Copier/Printer Count".

2 Configure the settings.

- 1 Press [Total] or [Individual].
- 2 Press [OK].

Unknown ID Job

This specifies the behavior for handling the jobs sent with unknown login user names or User ID (i.e. unsend IDs). If the User Login is set to invalid and Job Accounting is set to valid, follow the procedure when the Account ID is unknown. The setting items are as follows.

Item	Descriptions
Permit	The job is permitted to be printed.
Reject	The job is rejected (not printed).

1 Display the screen.

- 1 Referring to [User Login Setting on page 9-2](#), display the user login setting screen.
- 2 Press [Change] of "Unknown ID Job".

2 Configure the settings.

- 1 Press [Reject] or [Permit].
- 2 Press [OK].

10 Troubleshooting

This chapter explains the following topics:

Regular Maintenance	10-2
Cleaning	10-2
Toner Container Replacement	10-6
Waste Toner Box Replacement	10-9
Replacing Staples	10-12
Disposing of the Punch Waste	10-16
Troubleshooting	10-18
Solving Malfunctions	10-18
Responding to Messages	10-23
Adjustment/Maintenance	10-36
Clearing Paper Jams	10-39
Clearing a Staple Jam	10-63

Regular Maintenance

Cleaning

Clean the machine regularly to ensure optimum printing quality.



CAUTION

For safety, always unplug the power cord before cleaning the machine.

Platen Cover/Glass Platen

Wipe the backside of the platen cover, the inside of the document processor and the glass platen with a soft cloth dampened with alcohol or mild detergent.



IMPORTANT

Do not use thinner or other organic solvents.

Slit Glass/Dual scanning area

If black streaks or dirt appears in copies when using the optional document processor, clean the slit glass with the supplied cleaning cloth. When using the document processor that features dual scanning, clean the dual scanning unit also.

✔ IMPORTANT

Wipe the slit glasses with the dry accessory cloth. Do not use water, soap or solvents for cleaning.

1

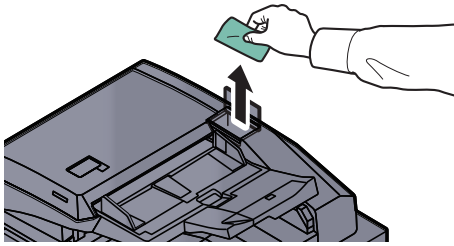

2

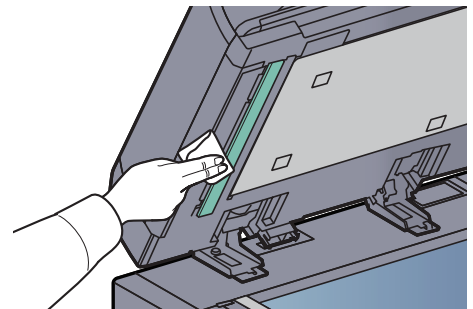
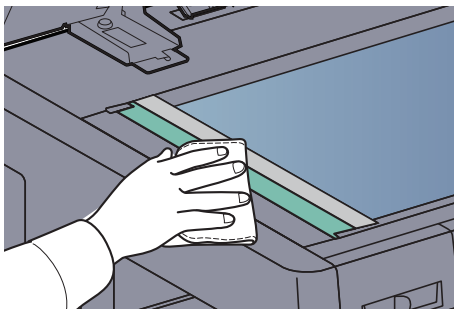

3

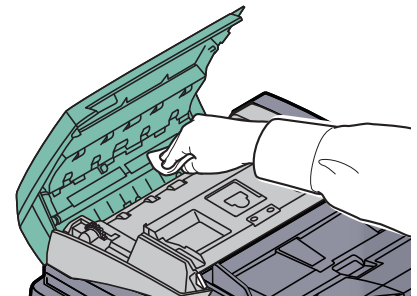
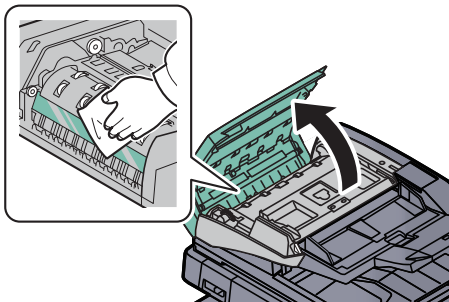

Machine Interior

Clean the conveyor guide regularly (at least monthly) to ensure optimum printing quality.

✔ IMPORTANT

Wipe the conveyor guide with the dry accessory cloth. Do not use water, soap or solvents for cleaning. Do not touch the photoconductor drum.

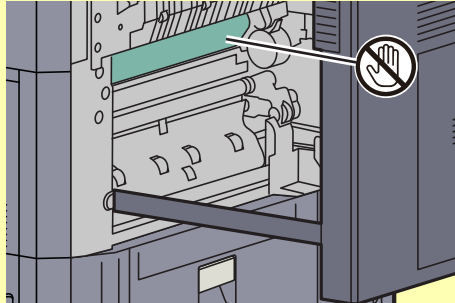

1

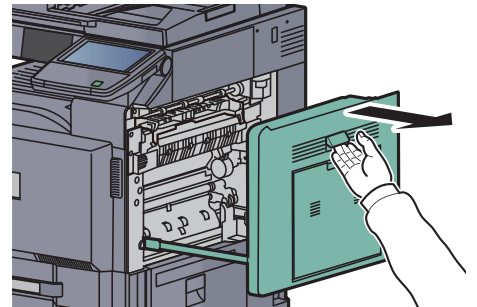
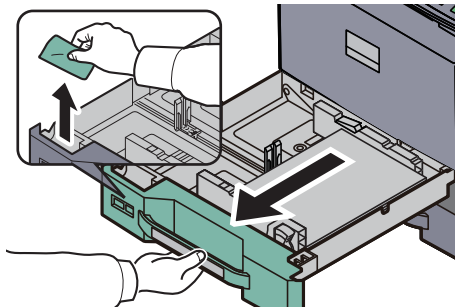

2

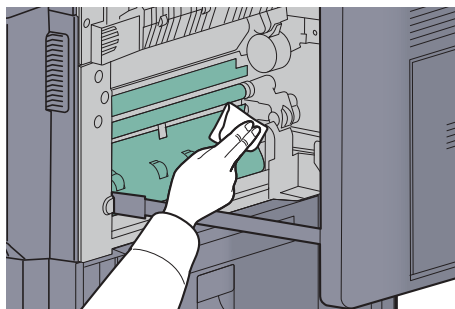

3

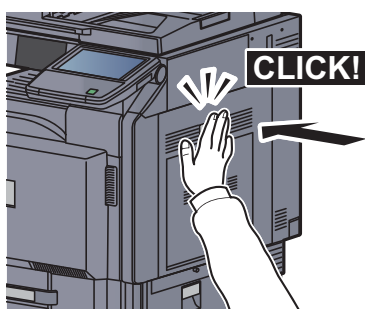

Separator

Clean the separator regularly (at least monthly) to ensure optimum printing quality.

1

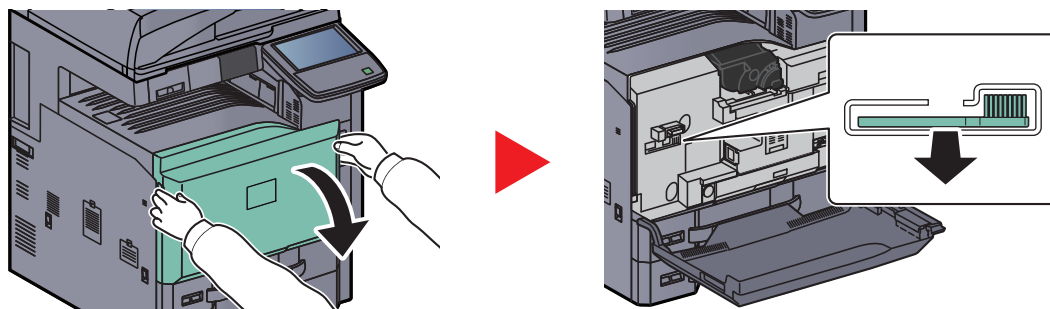

2

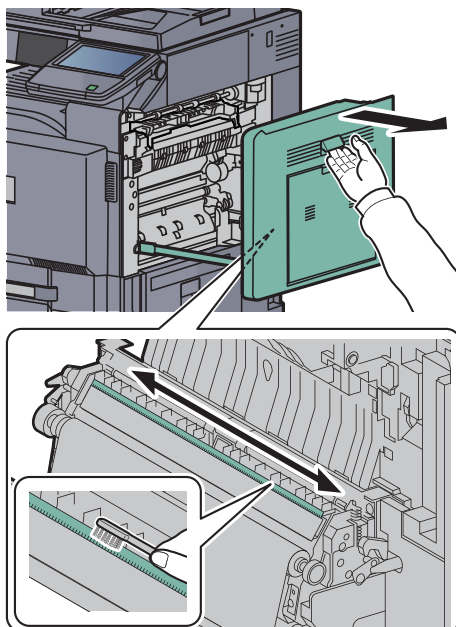

3

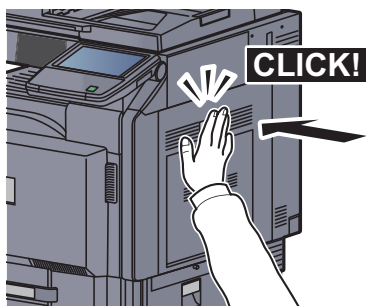

Toner Container Replacement

When toner runs low, "Toner is low. (Replace when empty)" appears in the touch panel. Make sure you have a new toner container available for replacement.

When the touch panel displays "Toner is empty.", replace the toner.

NOTE

- For the toner container, always use a genuine toner container. Using a toner container that is not genuine may cause image defects and product failure.
- The memory chip in the toner container of this product stores information necessary for improving customer convenience, operation of the recycling system for used toner containers, and planning and development of new products. The stored information does not include information that makes it possible to identify individuals, and is only used anonymously for the above purposes.

CAUTION

Do not attempt to incinerate parts which contain toner. Dangerous sparks may cause burns.

1

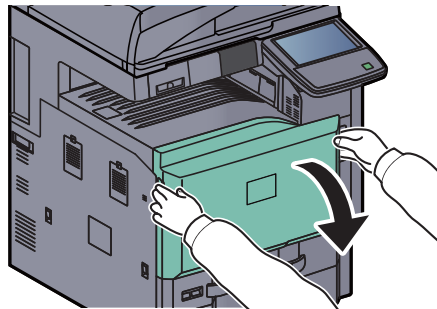

2

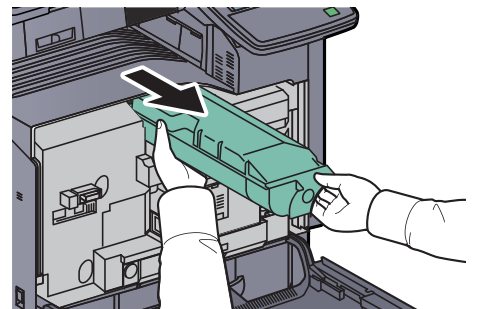
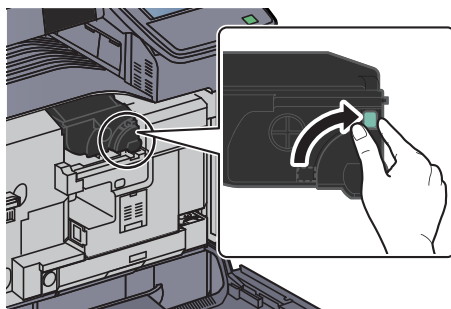

3

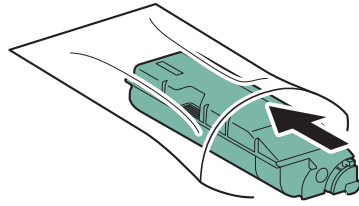

4

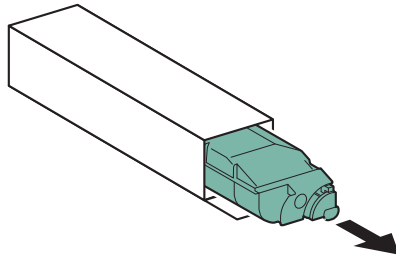

5

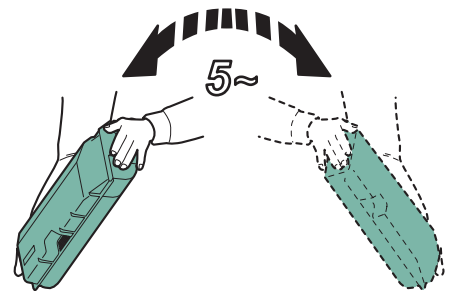
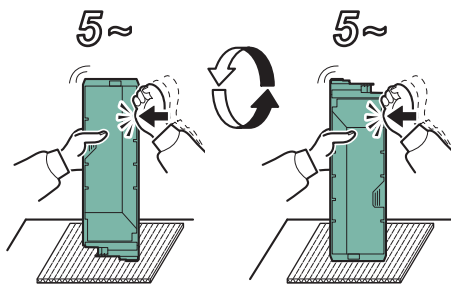

6

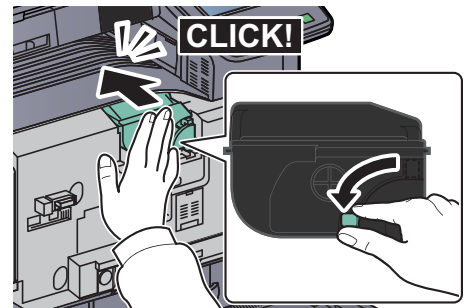
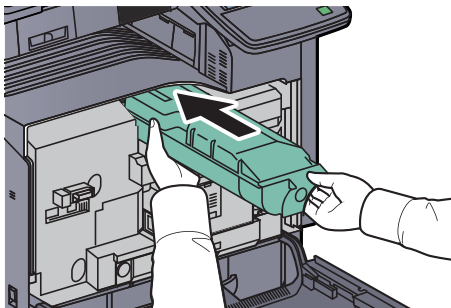

7

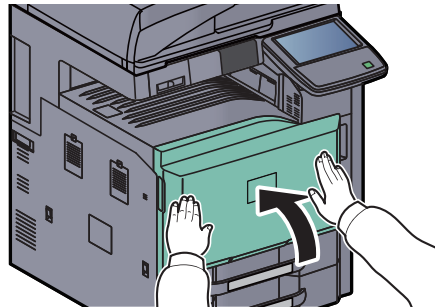

NOTE

Return the exhausted toner container and waste toner box to your dealer or service representative. The collected toner container and waste toner box will be recycled or disposed in accordance with the relevant regulations.

Waste Toner Box Replacement

When "Waste toner box almost full" appears in the touch panel, make sure you have a new waste toner box available for replacement.

When the touch panel shows "Check waste toner box.", immediately replace the waste toner box.



CAUTION

Do not attempt to incinerate parts which contain toner. Dangerous sparks may cause burns.

1

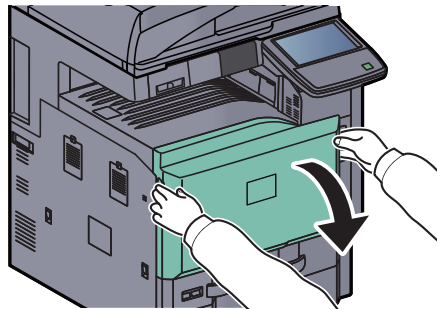

2

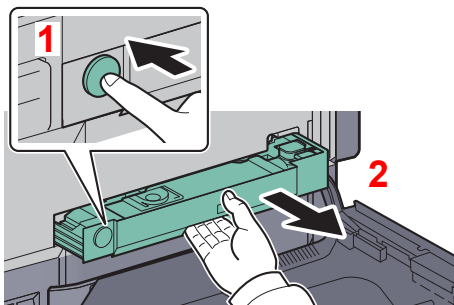

3

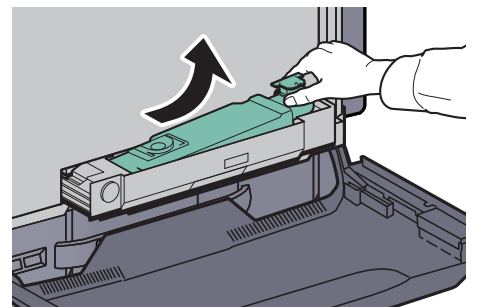
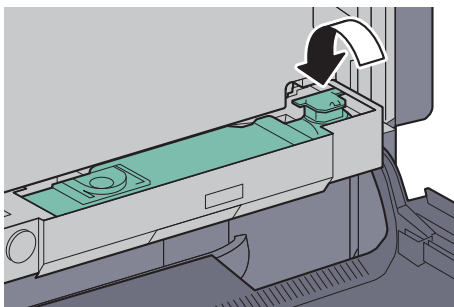

4

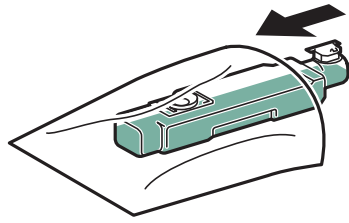

5

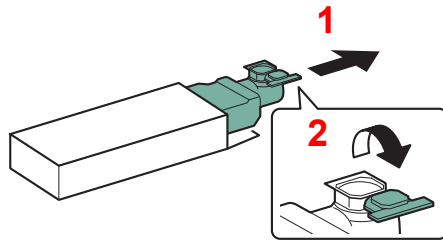

6

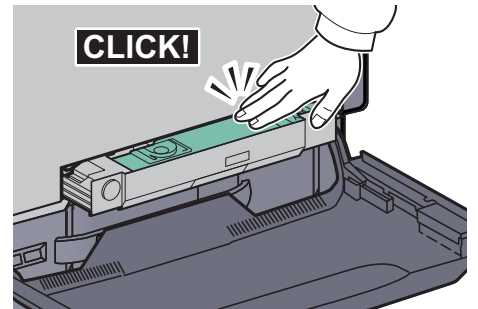
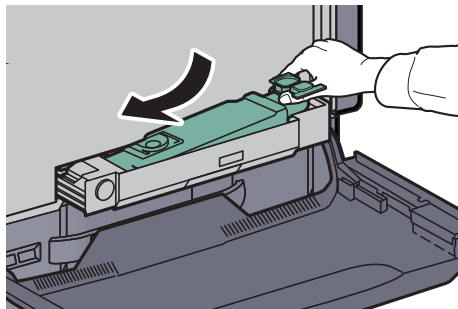

7

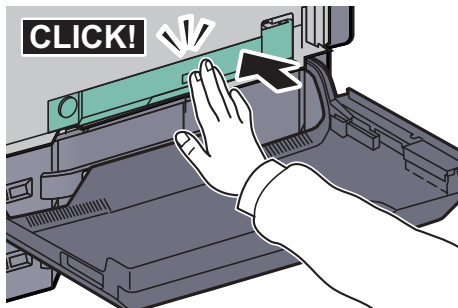

8

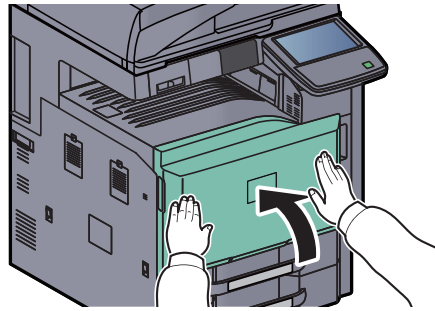

 **NOTE**
Return the exhausted toner container and waste toner box to your dealer or service representative. The collected toner container and waste toner box will be recycled or disposed in accordance with the relevant regulations.

Replacing Staples

A staple cartridge is installed in the optional 1,000-Sheet Finisher, 4,000-Sheet Finisher, and center-fold unit.

If a message displays indicating that staples have run out, the staple cartridge holder need to be replenished with staples.

 **NOTE**

If the Staple Unit runs out of staples, contact your service representative or the place of purchase.

Follow the steps below to refill staples.

1,000-Sheet Finisher (Option)

1

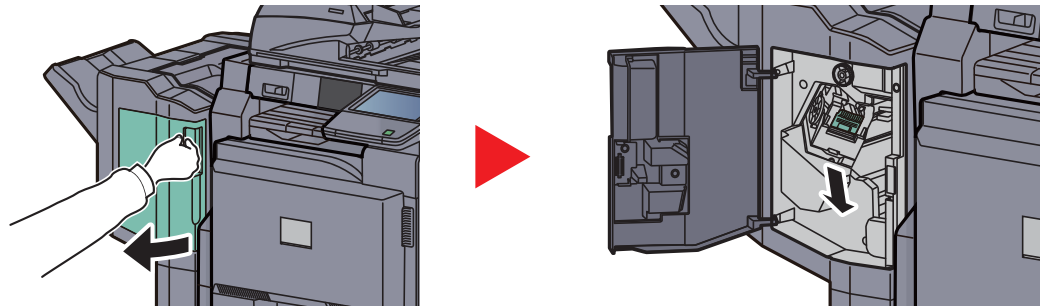

2

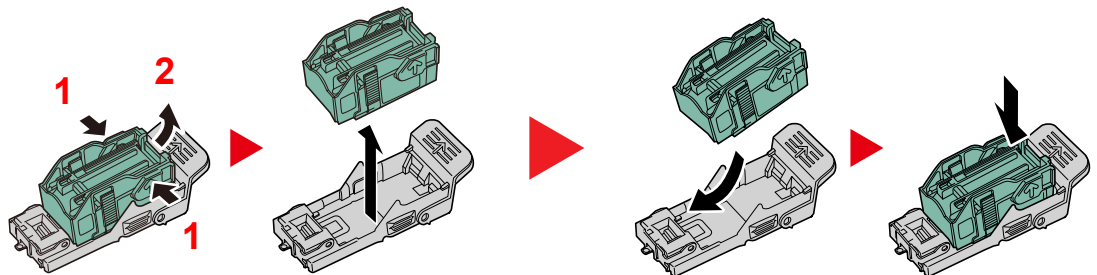

 **NOTE**

The staple cartridge can only be removed when it contains no more staples.

3

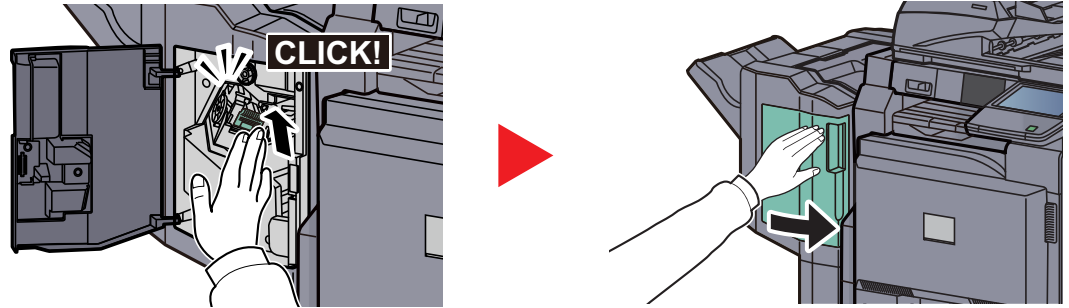

4,000-Sheet Finisher (Option)

The 4,000-Sheet Finisher contains staple cartridge holder A.

The optional folding unit contains staple cartridge holders B and C. The refill procedure for staple cartridge holders B and C are the same as for staple cartridge holder A.

Refilling Staple Cartridge Holder A

 **NOTE**

See page 10-14 to refill staple cartridge holder B/C of the optional folding unit.

1

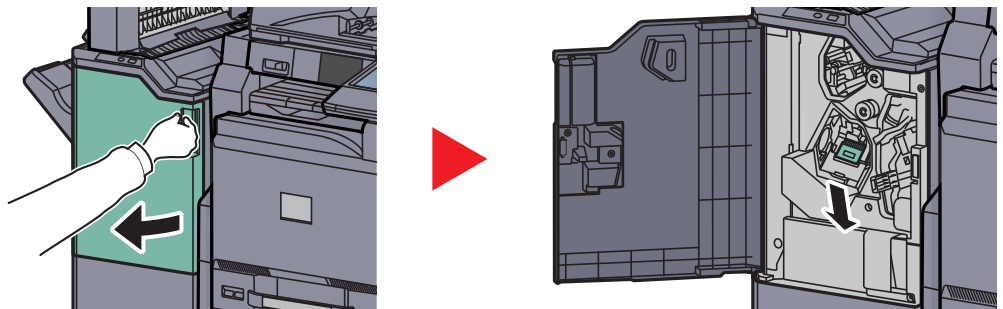

2

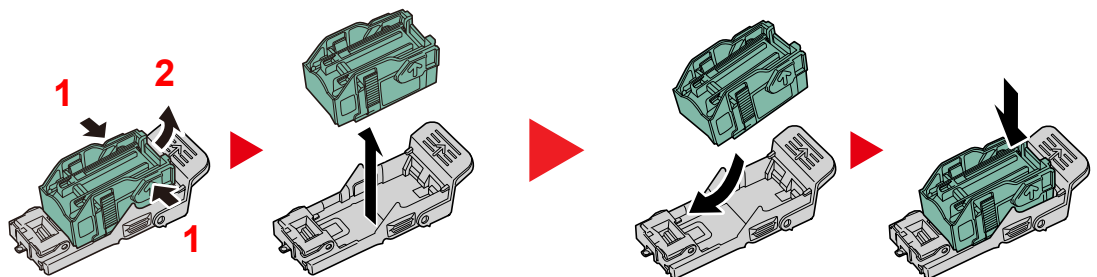

 **NOTE**

The staple cartridge can only be removed when it contains no more staples.

3

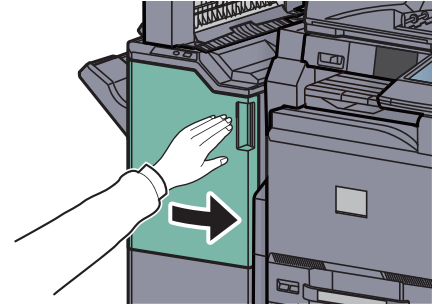
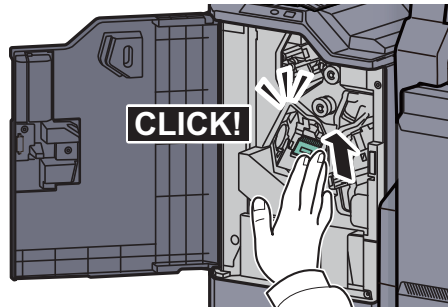

Refilling Staple Cartridge Holders B/C (Option)

Follow the steps below to refill staples for the optional folding unit. Follow the same procedure to refill staple cartridge holders B and C.

1

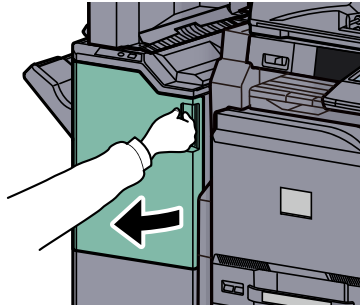

2

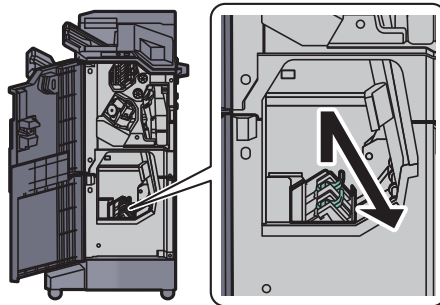

3

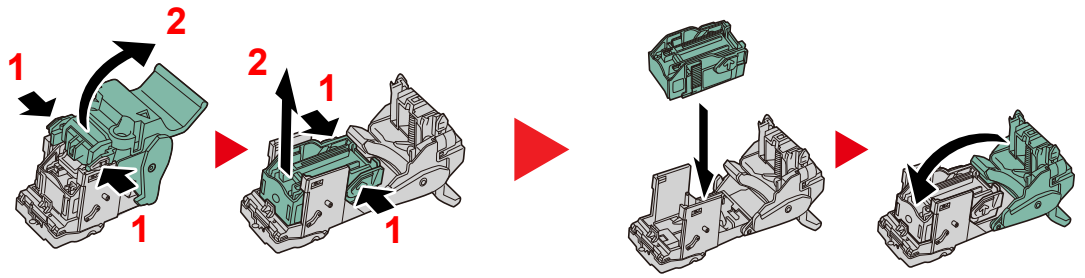

NOTE

The staple cartridge can only be removed when it contains no more staples.

4

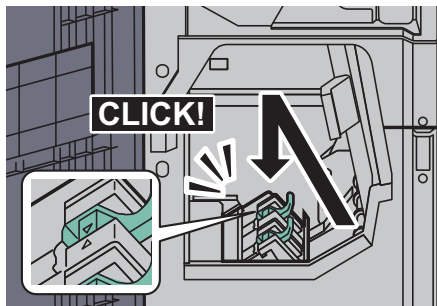

5

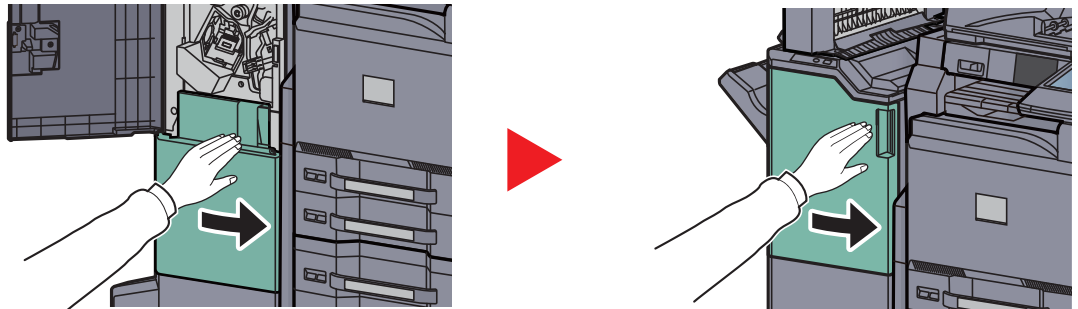

Disposing of the Punch Waste

If a message is displayed on the machine operation panel indicating that the waste punch box is full, be sure to empty the scraps in the punch waste box.

Leave the main power switch on the machine switched ON (|) while performing this procedure.

1,000-Sheet Finisher (Option)

1

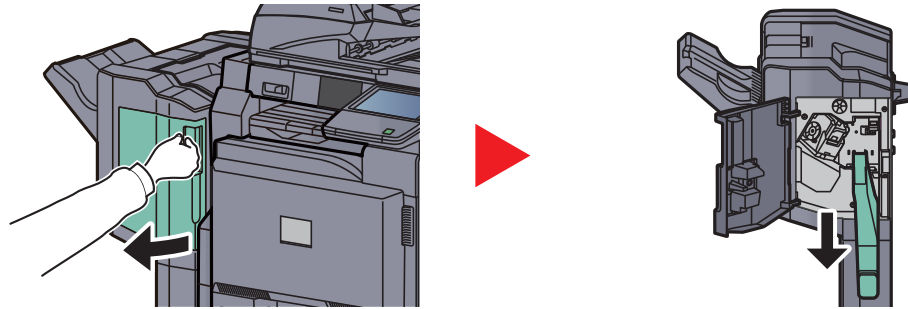

NOTE

Take care not to spill the waste hole punch scraps when removing the container.

2

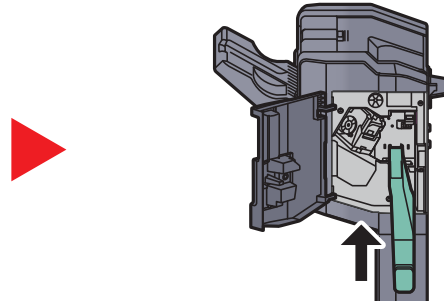

3

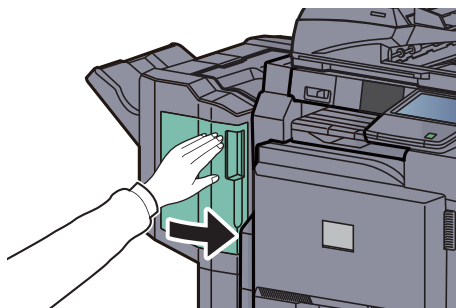

4,000-Sheet Finisher (Option)

1

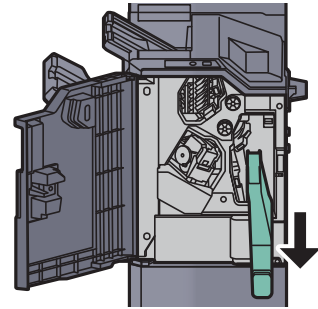
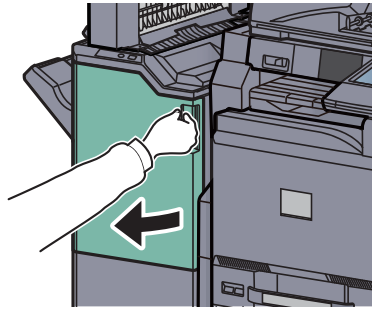

NOTE

Take care not to spill the waste hole punch scraps when removing the container.

2

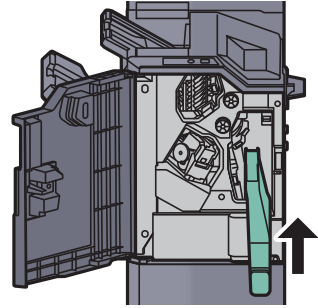
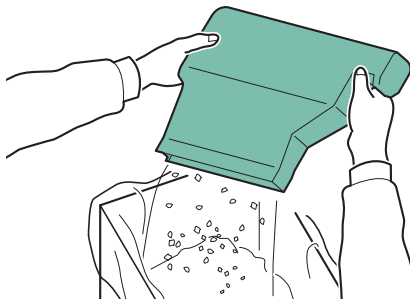

3

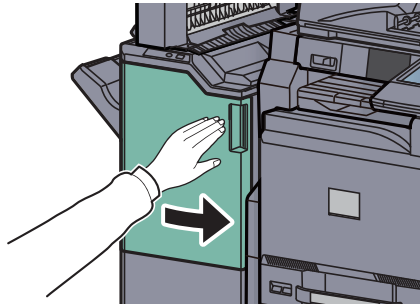







Troubleshooting

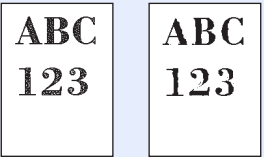

Solving Malfunctions

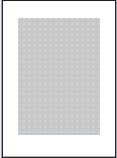

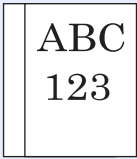
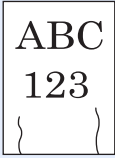

The table below provides general guidelines for problem solving.

If a problem occurs with your machine, look into the checkpoints and perform procedures indicated on the following pages. If the problem persists, contact your Service Representative.

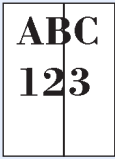
Symptom	Checkpoints	Corrective Actions	Reference Page
An application does not start.	Is the Auto Panel Reset time short?	Set the Auto Panel Reset time to 30 seconds or more.	page 8-54
The screen does not respond when the main power switch is turned on.	Is the machine plugged in?	Plug the power cord into an AC outlet.	page 2-9
Pressing the [Start] key does not produce copies.	Is there a message on the screen?	Determine the appropriate response to the message and respond accordingly.	page 10-23
	Is the machine in Sleep mode?	Press the [Power] key to recover the machine from Sleep mode.	page 3-15
Blank sheets are ejected. 	Are the originals loaded correctly?	When placing originals on the platen, place them face-down and align them with the original size indicator plates.	page 5-2
	—	When placing originals in the document processor, place them face-up.	page 5-3
	—	Check that the settings of the application software.	—
Printouts are totally too light. 	Is the paper damp?	Replace the paper with new paper.	page 3-16
	Have you changed the density?	Select appropriate density level.	page 6-21 page 8-57
	Is the toner distributed evenly within the toner container?	Shake the toner container from side to side several times.	page 10-6
	Is EcoPrint mode enabled?	Disable [EcoPrint] mode.	page 8-18
	—	Run [Drum Refresh 1].	page 10-37
	—	Run [Developer Refresh].	page 10-38
	—	Make sure the paper type setting is correct for the paper being used.	page 8-10
Printouts are too dark even though the background of the scanned original is white. 	Have you changed the density?	Select appropriate density level.	page 6-21 page 8-57
	—	Run [Calibration].	page 10-38
	—	Run [Developer Refresh].	page 10-38

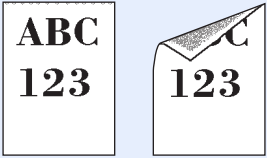
Symptom	Checkpoints	Corrective Actions	Reference Page
<p>Copies have a moire pattern (dots grouped together in patterns and not aligned uniformly).</p> 	Is the original a printed photograph?	Set the original image to [Printer Output] or [Book/Magazine] in [Photo].	page 6-22
<p>Texts are not clearly printed.</p> 	Did you choose appropriate image quality for the original?	Select appropriate image quality.	page 6-22
<p>Black or color dots appear on the white background when white original is scanned.</p> 	Is the original holder or the glass platen dirty?	Clean the original holder or the glass platen.	page 10-2
	Is the conveying guide dirty?	Clean the conveying guide.	page 10-4
	—	Run [Developer Refresh].	page 10-38
<p>Printouts are fuzzy.</p> 	Is the machine being used in conditions of very humid, or humidity or temperature rapidly changes?	Use in an environment that has suitable humidity.	—
	—	Run [Drum Refresh 1].	page 10-37
<p>Images are skewed.</p> 	Are the originals loaded correctly?	When placing originals on the platen, align them with the original size indicator plates.	page 5-2
	—	When placing originals in the document processor, align the original width guides securely before placing the originals.	page 5-3
	Is the paper loaded correctly?	Check the position of the paper width guides.	page 3-18 page 3-26
<p>Paper often jams.</p>	Is the paper loaded correctly?	Load the paper correctly.	page 3-18 page 3-26
	—	Turn the orientation 180 degrees around in which the paper is positioned.	page xiv page 3-18 page 3-26
	Is the paper of the supported type? Is it in good condition?	Remove the paper, turn it over, and reload it.	page 3-18
	Is the paper curled, folded or wrinkled?	Replace the paper with new paper.	page 3-18
	Are there any loose scraps or jammed paper in the machine?	Remove any jammed paper.	page 10-39

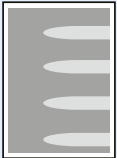
Symptom	Checkpoints	Corrective Actions	Reference Page
2 or more sheets are overlaps when ejected. (multi feed) 	—	Load the paper correctly.	page 3-18 page 3-26
Printouts are wrinkled. 	Are the originals loaded correctly?	Load the paper correctly.	page 3-18 page 3-26
	—	Clean the paper separator.	page 10-5
	—	Turn the orientation 180 degrees around in which the paper is positioned.	page xiv page 3-18 page 3-26
	Is the paper damp?	Replace the paper with new paper.	page 3-16
Printouts are curled. 	—	Turn the paper over in the cassette, or turn the orientation 180 degrees around in which the paper is positioned.	page xiv page 3-18 page 3-26
	Is the paper damp?	Replace the paper with new paper.	page 3-16
	Is the paper printed out to the finisher?	Change the [Correct Paper Curl].	page 8-59
	—	Check the specified cassette and change its paper type to Custom 8.  NOTE If you specify the paper type to Custom 8, copy speed or printing speed becomes slower.	page 3-31
Cannot print.	Is the machine plugged in?	Plug the power cord into an AC outlet.	—
	Is the machine powered on?	Turn on the main power switch.	page 2-10
	Are the printer cable and network cable connected?	Connect the correct printer cable and network cable securely.	page 2-6
	Was the machine powered on before the printer cable was connected?	Power on the machine after connecting the printer cable.	—
	Is the print job paused?	Resume printing.	page 7-4
Cannot print with USB memory. USB memory not recognized.	Is the USB host blocked?	Select [Unblock] in the USB host settings.	page 8-50
	—	Check that the USB memory is securely plugged into the machine.	—
Printouts have vertical lines. 	Are the slit glass and the Dual scanning area dirty?	Clean the slit glass and the Dual scanning area.	page 10-3

Symptom	Checkpoints	Corrective Actions	Reference Page
<p>Dirt on the top edge or back of the paper.</p>  <p>Dirt on the both sides of the paper.</p> 	<p>Check the machine interior.</p>	<p>Open the right cover. If the machine interior is dirty with toner, clean it using soft, dry, lint-free cloth.</p>	<p>page 10-4</p>
<p>Part of the image is periodically faint or shows white lines.</p> 	<p>—</p> <p>—</p>	<p>Run [Drum Refresh 1].</p> <p>Run [Developer Refresh].</p>	<p>page 10-37</p> <p>page 10-38</p>
<p>Print on the back of the sheet is visible on the front.</p> 	<p>—</p>	<p>Set [Prevent Bleed-through] to [On].</p>	<p>page 6-25</p> <p>page 8-17</p>
<p>White dots appear on the image.</p> 	<p>—</p>	<p>Run [Drum Refresh2].</p>	<p>page 10-37</p>
<p>Colors appear different than you anticipated.</p>	<p>—</p>	<p>Run [Tone Curve Adjustment].</p>	<p>page 10-36</p>
<p>Perform Tone Curve Adjustment in the System Menu. is displayed.</p>	<p>Over long periods of use, the effects of the ambient temperature and humidity can cause output hues to vary slightly.</p>	<p>Run [Tone Curve Adjustment].</p>	<p>page 10-36</p>
<p>Cannot create Searchable PDF file.</p>	<p>Is the proper language selected?</p>	<p>Check the language to extract.</p>	<p>page 6-59</p>
	<p>Can the texts on the original not be recognized as texts, or is the PDF creation time taken?</p>	<p>Check the following:</p> <ul style="list-style-type: none"> The original orientation is correct. When setting the originals with the mixed orientation at once, [On] is selected for [Auto Image Rotation]. 	<p>page 6-59</p>

Symptom	Checkpoints	Corrective Actions	Reference Page
Cannot search a text that you want to search on the PDF file.	Have you set [OCR Text Recognition] in [File Format]?	Set [OCR Text Recognition] in [File Format].	page 6-59
	Are the texts of the scanned original faded or too light?	Set [Density] to darker level.	page 6-21
	Is the background of the scanned original too dark and the texts are difficult to recognize?	Set [Background Density Adj.] to [On] or [Manual] and manually adjust the density lighter. Otherwise, set [Density] to darker level.	page 6-21 page 6-24
	Is the text or image on the back of the original visible on the front?	Set [Prevent Bleed-through] to [On].	page 6-25
Cannot send via SMB.	Is the network cable connected?	Connect the correct network cable securely.	page 2-6
	Have the network settings for the equipment been configured properly?	Configure the TCP/IP settings properly.	page 8-43
	Have the folder sharing settings been configured properly?	Check sharing settings and access privileges under the folder properties.	—
	Has the SMB protocol been set to [On]?	Set the SMB protocol setting to [On].	page 5-31
	Has [Host Name] been entered properly? *1	Check the name of the computer to which data is being sent.	page 5-31
	Has [Path] been entered properly?	Check the share name for the shared folder.	page 5-31
	Has [Login User Name] been entered properly? *1*2	Check the domain name and login user name.	page 5-31
	Has the same domain name been used for [Host Name] and [Login User Name]?	Delete the domain name and backslash ("\") from [Login User Name].	page 5-31
	Has [Login Password] been entered properly?	Check the login password.	page 5-31
	Have exceptions for Windows Firewall been configured properly?	Configure exceptions for Windows Firewall properly.	page 3-42
	Do the time settings for the equipment, domain server, and data destination computer differ?	Set the equipment, domain server, and data destination computer to the same time.	—
Is the screen displaying Send error?	Refer to Responding to Send Error .	page 10-33	
Cannot find the machine with WSD.	Did you search by specifying the machine's IP address or host name?	For security reasons, [HTTP] protocol is set to [Off], and therefore you cannot search by IP address or host name.	—
Cannot send via the e-mail.	Is the E-mail send size limit set in the SMTP server registered on the machine?	Check the limit value is entered to "E-mail Size Limit" of [E-mail] setting in Command Center RX and change the value as necessary.	page 2-37

*1 You can also enter a full computer name as the host name (for example, pc001.abcdnet.com).

*2 You can also enter login user names in the following formats:
 Domain_name/user_name (for example, abcdnet/james.smith)
 User_name@domain_name (for example, james.smith@abcdnet)

Responding to Messages

If the touch panel or the computer displays any of these messages, follow the corresponding procedure.

A

Message	Checkpoints	Corrective Actions	Reference Page
Acceptable fold count exceeded.	Is the acceptable number of sheets exceeded?	Press [Continue] to print using Fold per acceptable number of sheets. Press [Cancel] to cancel the job.	page 6-16
Acceptable staple count exceeded.*	Is the acceptable number of sheets exceeded?	Press [Continue] to print without using Staple. Press [Cancel] to cancel the job.	—
Activation error.	—	Failed to activate the application. Contact administrator.	—
	—	Expansion Authentication is disabled. Turn the main power switch off and on. If the error exists, contact administrator.	—
Add paper in cassette #.	Is the indicated cassette out of paper?	Load paper. Select the available paper. Press [Continue] to print.	page 3-16
Add paper in Multi Purpose tray.	Is the paper of the selected size loaded in the multi purpose tray?	Load paper. Select the available paper. Press [Continue] to print.	page 3-26
Adjusting Scanner.	—	The machine is under the adjustment to maintain its quality. Please wait.	—

* When Auto Error Clear is set to [On], processing resumes automatically after a set amount of time elapses.

B

Message	Checkpoints	Corrective Actions	Reference Page
Box is not found.	—	The specified box cannot be found. Job is canceled. Press [End].	—
Box limit exceeded.*	Is [End] displayed on the screen?	The specified box is full, and no further storage is available. Job is canceled. Press [End]. Try to perform the job again after printing or deleting data from the box. The job is canceled. Press [End]. Refer to Responding to Send Error for the error code and corrective actions.	—
	—	Repeat Copy box is full, and no further repeat copy is available. Press [Continue] to print scanned pages. Press [Cancel] to cancel the job.	—

* When Auto Error Clear is set to [On], processing resumes automatically after a set amount of time elapses.

C

Message	Checkpoints	Corrective Actions	Reference Page
Calibrating...	—	The machine is under the adjustment to maintain its quality. Please wait.	—
Cannot connect to Authentication Server.*	—	Set machine time to match the server's time.	page 2-23
	—	Check the domain name.	page 9-2
	—	Check the domain name.	page 9-2
	—	Check the connection status with the server.	—
Cannot connect to Server.	—	Check the connection status with the server.	—
Cannot duplex print on this paper.*	Did you select a paper size/type that cannot be duplex printed?	If the selected paper is not changed and [Continue] is pressed, duplex is released. Select the available paper. Press [Continue] to print.	page 6-38
Cannot find the destination computer. Check the computer.	Is the machine and the PC to which the scanned image is to be sent connected to the network?	Check the network and SMB settings. <ul style="list-style-type: none"> The network cable is connected. The hub is not operating properly. The server is not operating properly. Host name and IP address Port number 	page 2-6
	Is the account information (user ID, password) used to access the shared folder to which the scanned image is to be sent incorrect?	Check the following settings of the PC to which the scanned image is to be sent. <ul style="list-style-type: none"> Host name Path Login user name  NOTE If the sender is a domain user, specify the domain name. [Login User ID]@[Domain Name] Example: sa720XXXX@km <ul style="list-style-type: none"> Login password Folder share permissions of the recipient 	—
Cannot fold this paper.	Did you select a paper size/type that cannot be folded?	If the selected paper is not changed and [Continue] is pressed, fold is released. Select the available paper. Press [Continue] to print.	page 6-16

Message	Checkpoints	Corrective Actions	Reference Page
Cannot offset this paper.*	Did you select a paper size/type that cannot be offset?	If the selected paper is not changed and [Continue] is pressed, offset is released. Select the available paper. Press [Continue] to print.	page 6-17
Cannot perform remote printing.	—	Remote printing is prohibited. The job is canceled. Press [End].	page 8-27
Cannot print the specified number of copies.*	—	Only one copy is available. Press [Continue] to continue printing. Press [Cancel] to cancel the job.	—
Cannot process this job.*	—	Restricted by Authorization settings. The job is canceled. Press [End].	—
	—	Restricted by Job Accounting. The job is canceled. Press [End].	page 9-29
Cannot punch at the specified position.	Have you selected a position that cannot be punched?	If the selected paper is not changed and [Continue] is pressed, punch is released. Select the available paper. Press [Continue] to print.	page 6-19
Cannot punch this paper.	Did you select a paper size/type that cannot be punched?	If the selected paper is not changed and [Continue] is pressed, punch is released. Select the available paper. Press [Continue] to print.	page 6-19
Cannot staple at the specified position.	Have you selected a position that cannot be stapled?	If the selected paper is not changed and [Continue] is pressed, staple is released. Select the available paper. Press [Continue] to print.	page 6-18
Cannot staple this paper.*	Did you select a paper size/type that cannot be stapled?	If the selected paper is not changed and [Continue] is pressed, staple is released. Select the available paper. Press [Continue] to print.	page 6-18
Cannot use ##### due to a failure.	—	Call service.	—
Check the document processor.	Is the top cover of the document processor open?	Close the document processor cover.	—
	Is the document processor open?	Close the document processor.	—
Check the main unit right tray.	Is the main unit right tray closed?	Open the main unit right tray.	—
	Is the acceptable storage capacity exceeded?	Remove the paper. Printing then resumes.	—
Check the paper in the multi purpose tray.	—	The paper size is different. Set selected size paper and press [Continue].	page 3-34
Check the side feeder.	—	The side feeder is not installed correctly. Attach the side feeder.	—

Message	Checkpoints	Corrective Actions	Reference Page
Check waste toner box.	—	The waste toner box is not installed correctly. Set it correctly.	page 10-9
	Is the waste toner box full?	Replace the waste toner box.	page 10-9
Confidential document was detected.	—	The machine detects the document guard pattern. Job is canceled. Press [End].	—

* When Auto Error Clear is set to [On], processing resumes automatically after a set amount of time elapses.

E

Message	Checkpoints	Corrective Actions	Reference Page
Empty the punch waste box.	Is the punch waste box full?	Follow the instructions on the screen. and empty the punch waste box.	page 10-16
Error occurred at cassette #.	—	Open the cassette. Check inside the machine and remove the paper.	—
Error occurred at the multi purpose tray.	—	Remove the paper from the multi purpose tray.	—

F

Message	Checkpoints	Corrective Actions	Reference Page
Failed to specify Job Accounting.*	—	Failed to specify Job Accounting when processing the job externally. The job is canceled. Press [End].	—
Failed to store job retention data.	—	The job is canceled. Press [End].	—
Finisher left tray is full of paper.	Is the acceptable storage capacity exceeded?	Remove the paper. Printing then resumes.	—
	Is the paper curled?	Check the checkpoints of "Printouts are curled." in Solving Malfunctions and take the corrective actions.	page 10-20
Folding tray is full of paper.	Is the acceptable storage capacity exceeded?	Remove the paper. Printing then resumes.	—

* When Auto Error Clear is set to [On], processing resumes automatically after a set amount of time elapses.

H

Message	Checkpoints	Corrective Actions	Reference Page
Hard Disk error.	—	<p>An error has occurred on the hard disk. Job is canceled. Press [End].</p> <p>The possible error codes and their descriptions are as follows.</p> <p>01: The amount of data that can be saved at once has been exceeded. Restart the system or turn the power OFF/ON. If the error still occurs, divide the file into smaller files.</p> <p>If the error occurs after the file is divided, the hard disk is damaged. Execute [System Initialization].</p> <p>04: Insufficient space on the hard disk to complete this operation. Move data or delete unneeded data.</p>	—

I

Message	Checkpoints	Corrective Actions	Reference Page
Incorrect account ID.*	—	The account ID was incorrect when processing the job externally. The job is canceled. Press [End].	—
Incorrect box password.	—	The box password was incorrect when processing the job externally. The job is canceled. Press [End].	—
Incorrect Login User Name or Password.*	—	The login user name or password was incorrect when processing the job externally. The job is canceled. Press [End].	—
Install the punch waste box.	—	Follow the instructions on the screen. and install the punch waste box.	page 10-16
Invalid configuration.	Are the originals loaded correctly?	<p>When placing originals on the platen, place them face-down and align them with the original size indicator plates.</p> <p>When placing originals in the document processor, place them face-up.</p>	—

* When Auto Error Clear is set to [On], processing resumes automatically after a set amount of time elapses.

J

Message	Checkpoints	Corrective Actions	Reference Page
Job Accounting restriction exceeded.*	Is the acceptable printing count restricted by Job Accounting exceeded?	The printing count exceeded the acceptable count restricted by Job Accounting. Cannot print any more. The job is canceled. Press [End].	—
Job separator tray is full of paper.	Is the acceptable storage capacity exceeded?	Remove the paper and press [Continue]. Printing then resumes.	—
	Is the paper curled?	Check the checkpoints of "Printouts are curled." in Solving Malfunctions and take the corrective actions.	page 10-20

* When Auto Error Clear is set to [On], processing resumes automatically after a set amount of time elapses.

K

Message	Checkpoints	Corrective Actions	Reference Page
KPDL error.*	—	PostScript error has occurred. The job is canceled. Press [End].	—

* When Auto Error Clear is set to [On], processing resumes automatically after a set amount of time elapses.

M

Message	Checkpoints	Corrective Actions	Reference Page
Machine failure.	—	Internal error has occurred. Make a note of the error code displayed on the screen. Call service.	—
Mailbox tray is full of paper.	Is the acceptable storage capacity exceeded?	Remove the paper. Printing then resumes.	—
Main unit inner tray is full of paper.	Is the acceptable storage capacity exceeded?	Remove the paper. Printing then resumes.	—
	Is the paper curled?	Check the checkpoints of "Printouts are curled." in Solving Malfunctions and take the corrective actions.	page 10-20
Main unit upper left tray is full of paper.	Is the acceptable storage capacity exceeded?	Remove the paper and press [Continue]. Printing then resumes.	—
Maximum number of scanned pages.	Is the acceptable scanning count exceeded?	Cannot scan pages any more. Follow the instructions on the screen.	—
Memory is full.*	—	The memory is full and the job cannot be continued. Press [Continue] to print the scanned pages. The print job cannot be processed completely. Press [Cancel] to cancel the job.	—
	—	The process cannot be performed due to insufficient memory. If only [End] is available, press [End]. The job will be canceled.	—

* When Auto Error Clear is set to [On], processing resumes automatically after a set amount of time elapses.

P

Message	Checkpoints	Corrective Actions	Reference Page
Paper jam.	—	If a paper jam occurs, the machine will stop and the location of the jam will be indicated on the screen. Leave the machine on and follow the instructions to remove the jammed paper.	page 10-39
Paper left.	—	Remove paper from the document finisher.	—
Performing Drum Refresh...	—	The machine is under the adjustment to maintain its quality. Please wait.	—
Perform Tone Curve Adjustment in the System Menu.	Over long periods of use, the effects of the ambient temperature and humidity can cause output hues to vary slightly.	Run [Tone Curve Adjustment].	page 10-36
Preparing to print.	—	The machine is under the adjustment to maintain its quality. Please wait.	—

R

Message	Checkpoints	Corrective Actions	Reference Page
Regulating the temperature...	—	The machine is under the adjustment to maintain its quality. Please wait.	—
Removable memory error.*	Is writing to a removable memory prohibited?	An error occurred in the removable memory. The job stopped. Press [End]. The possible error codes and their descriptions are as follows. 01: Connect a removable memory that can be written to.	—
	—	An error occurred in the removable memory. The job stopped. Press [End]. The possible error codes and their descriptions are as follows. 01: The amount of data that can be saved at once has been exceeded. Restart the system or turn the power OFF/ON. If the error still occurs, divide the file into smaller files. If the error still occurs, the removable memory is not compatible with the machine. Use the removable memory formatted by this machine. If the removable memory cannot be formatted, it is damaged. Connect a compatible removable memory.	page 5-68

Message	Checkpoints	Corrective Actions	Reference Page
Removable Memory is full.*	—	The job is canceled. Press [End]. Insufficient free space in the removable memory. Delete unneeded files.	—
Remove originals in the document processor.	Are there any originals left in the document processor?	Remove originals from the document processor.	—
Replace all originals and press [Continue].	—	Remove originals from the document processor, put them back in their original order, and place them again. Press [Continue] to resume printing. Press [Cancel] to cancel the job.	—

* When Auto Error Clear is set to [On], processing resumes automatically after a set amount of time elapses.

S

Message	Checkpoints	Corrective Actions	Reference Page
Scanner memory is full.*	—	Scanning cannot be performed due to insufficient memory of the scanner. Follow the instructions on the screen.	—
Send Error.*	—	An error has occurred during transmission. The job is canceled. Press [End]. Refer to Responding to Send Error for the error code and corrective actions.	page 10-33
Skewed originals fed.	—	See the caution attached on the document processor and check the originals. If the originals are jammed, follow the instructions on the screen to remove the originals.	—
Staple is empty. (Manual Staple)	Has staple cartridge holder A run out of staples?	Add staples to staple cartridge holder A.	page 10-13
Staple is empty.*	Has staple cartridge holder run out of staples?	If the staples are depleted, the machine will stop and the location of staple depletion will be indicated on the screen. Leave the machine on and follow the instructions to replace the staple case. Press [Continue] to print without stapling. Press [Cancel] to cancel the job.	page 10-12
Staple jam.	—	If a staple jam occurs, the machine will stop and the location of the jam will be indicated on the screen. Leave the machine on and follow the instructions to remove the jammed staple.	page 10-63
System error.	—	System error has occurred. Follow the instructions on the screen.	—

* When Auto Error Clear is set to [On], processing resumes automatically after a set amount of time elapses.

T

Message	Checkpoints	Corrective Actions	Reference Page
The cover is open.	Is there any cover which is open?	Close the cover indicated on the screen.	—
The folding unit is open.	—	Close the folding unit.	—
The password does not meet password policy.	Is the password expired?	Change the login password. The job is canceled. Press [End].	page 9-7 page 9-8
	Is the password policy requirement (such as password length or required characters) changed?	Confirm the password policy requirements and change the login password. The job is canceled. Press [End].	page 9-7 page 9-8
The print system connected to the current port is not supported by the printer driver. Use a printer driver for this port that matches the print system.	Is the printer driver for this product used?	Check the product name of the machine and reinstall the printer driver.	—
The removable memory is not formatted.	Is the removable memory formatted by this machine?	Perform [Format] on this machine.	—
The slit glass requires cleaning.	—	Clean the slit glass using the cleaning cloth supplied with the document processor.	page 10-3
This user account is locked out.	—	Contact administrator. The job is canceled. Press [End].	—
Toner is empty.	—	Replace the toner container to our specified toner container.	page 10-6
Toner is low. (Replace when empty.)	—	It is almost time to replace the toner container. Obtain a new toner container.	—
Tray # is full of paper.	Is the acceptable storage capacity exceeded?	Remove the paper. Printing then resumes.	—
	Is the paper curled?	Check the checkpoints of "Printouts are curled." in Solving Malfunctions and take the corrective actions.	page 10-20

U

Message	Checkpoints	Corrective Actions	Reference Page
Unknown toner installed.	Is the installed toner container our own brand?	We will not be liable for any damage caused by the use of third party supplies in this machine.	—
Unknown Toner Installed. PC	Does the installed toner container's regional specification match the machine's?	Install the specified container.	—



W



Message	Checkpoints	Corrective Actions	Reference Page
Warning for high temperature. Adjust the room temperature.	—	Print quality may be deteriorated. Adjust the temperature and the humidity of your room.	—
Warning for low temperature. Adjust the room temperature.	—	Print quality may be deteriorated. Adjust the temperature and the humidity of your room.	—
Warning low memory.	—	Cannot start the job. Try again later.	—
Waste toner box almost full.	—	It is almost time to replace the waste toner box. Obtain a new waste toner box.	—

Y

Message	Checkpoints	Corrective Actions	Reference Page
You cannot use this box.	—	You cannot use the specified box. Job is canceled. Press [End].	—

Responding to Send Error

Error Code	Message	Corrective Actions	Reference Page
1101	Failed to send the e-mail. Failed to send i-FAX.	Check the host name of the SMTP server on the Command Center RX.	page 2-33
	Failed to send via FTP.	Check the host name of FTP.	—
	Failed to send via SMB.	Check the host name of SMB.	—
1102	Failed to send via SMB.	Check the SMB settings. <ul style="list-style-type: none"> Login user name and login password  NOTE If the sender is a domain user, specify the domain name. <ul style="list-style-type: none"> Host name Path 	—
	Failed to send the e-mail.	Check the following on the Command Center RX. <ul style="list-style-type: none"> SMTP login user name and login password POP3 login user name and login password E-mail size limit 	—
	Failed to send i-FAX.	Check the following on the Command Center RX. <ul style="list-style-type: none"> SMTP login user name and login password POP3 login user name and login password 	—
	Failed to send via FTP.	Check the FTP settings. <ul style="list-style-type: none"> Login user name and login password  NOTE If the sender is a domain user, specify the domain name. <ul style="list-style-type: none"> Path Folder share permissions of the recipient 	—
1103	Failed to send via SMB.	Check the SMB settings. <ul style="list-style-type: none"> Login user name and login password  NOTE If the sender is a domain user, specify the domain name. <ul style="list-style-type: none"> Path Folder share permissions of the recipient 	page 5-31
	Failed to send via FTP.	Check the FTP settings. <ul style="list-style-type: none"> Path Folder share permissions of the recipient 	—

Error Code	Message	Corrective Actions	Reference Page
1104	Failed to send the e-mail.	Check the E-mail address.  NOTE If the address is rejected by the domain, you cannot send the E-mail.	page 5-35
	Failed to send i-FAX.	Check the i-FAX address.  NOTE If the address is rejected by the domain, you cannot send the E-mail.	Refer to FAX Operation Guide .
1105	Failed to send via SMB.	Select [On] of the SMB settings on the Command Center RX.	page 2-33
	Failed to send the e-mail.	Select [On] of the SMTP settings on the Command Center RX.	page 2-33
	Failed to send via FTP.	Select [On] of the FTP settings on the Command Center RX.	page 2-33
	Failed to send i-FAX.	Select [On] of the i-FAX settings on the Command Center RX.	Refer to FAX Operation Guide .
1106	Failed to send the e-mail. Failed to send i-FAX.	Check the sender address of SMTP on the Command Center RX.	page 2-33
1131	Failed to send via FTP.	Select [On] of the secure protocol settings on the Command Center RX.	page 2-33
1132	Failed to send via FTP.	Check the following of the FTP server. <ul style="list-style-type: none"> • Is FTPS available? • Is the encryption available? 	page 2-33
2101	Failed to send via SMB.	Check the network and SMB settings. <ul style="list-style-type: none"> • The network cable is connected. • The hub is not operating properly. • The server is not operating properly. • Host name and IP address • Port number 	—
	Failed to send via FTP.	Check the network and FTP settings. <ul style="list-style-type: none"> • The network cable is connected. • The hub is not operating properly. • The server is not operating properly. • Host name and IP address • Port number 	—
	Failed to send the e-mail. Failed to send i-FAX.	Check the network and Command Center RX. <ul style="list-style-type: none"> • The network cable is connected. • The hub is not operating properly. • The server is not operating properly. • POP3 server name of the POP3 user • SMTP server name 	—

Error Code	Message	Corrective Actions	Reference Page
2102 2103	Failed to send via FTP.	Check the network and SMB settings. <ul style="list-style-type: none"> • The network cable is connected. • The hub is not operating properly. • The server is not operating properly. 	—
		Check the following of the FTP server. <ul style="list-style-type: none"> • Is FTP available? • The server is not operating properly. 	—
	Failed to send the e-mail. Failed to send i-FAX.	Check the network and SMB settings. <ul style="list-style-type: none"> • The network cable is connected. • The hub is not operating properly. • The server is not operating properly. 	—
2201 2202 2203 2231	Failed to send the e-mail. Failed to send via FTP. Failed to send via SMB. Failed to send i-FAX.	Check the network and SMB settings. <ul style="list-style-type: none"> • The network cable is connected. • The hub is not operating properly. • The server is not operating properly. 	—
2204	Failed to send the e-mail. Failed to send i-FAX.	Check the E-mail size limit of the SMTP settings on the Command Center RX.	—
3101	Failed to send the e-mail. Failed to send i-FAX.	Check the authentication methods of both the sender and the recipient.	—
	Failed to send via FTP.	Check the network and SMB settings. <ul style="list-style-type: none"> • The network cable is connected. • The hub is not operating properly. • The server is not operating properly. 	—
3201	Failed to send the e-mail. Failed to send i-FAX.	Check the authentication methods of both the sender and the recipient.	—
0007 4201 4701 5101 5102 5103 5104 7101 7102 7103 720f	—	Turn the main power switch off and back on. If this error occurs several times, make a note of the displayed error code and contact your service representative.	—
9181	—	The scanned original exceeds the acceptable number of pages of 999. Send the excess pages separately.	—

Adjustment/Maintenance

Tone Curve Adjustment

After prolonged use, or from the effects of surrounding temperature or humidity, the printed output tone may differ from the original. Perform this function to ensure consistency with the original tone. Before executing Tone Curve Adjustment, execute calibration (see page 10-38).

 **NOTE**

To perform tone curve adjustment, verify that either Letter or A4 paper is loaded into a cassette.

A total of 2 pattern pages (No. 1 and 2) are printed during adjustment. The printed patterns are read sequentially during the adjustment.

1 Display the screen.

- 1 Press the [System Menu] key.

System Menu



- 2 Press [∨], [Adjustment/Maintenance], [∨] and then [Next] of "Tone Curve Adjustment".

2 Adjust the tone curve.

- 1 Press [Start]. A pattern is printed.
Check that the number "1" is printed at the bottom of the pattern.
- 2 As shown in the illustration, place the printed side down on the platen with the edge with the arrows toward the back.

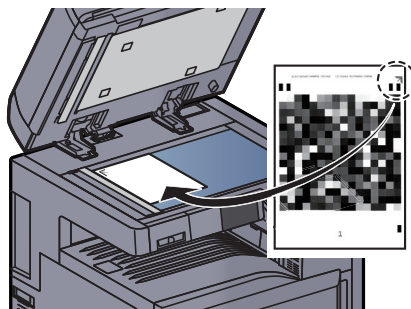

- 3 Press [Start]. The pattern is read and adjustment begins.
The second pattern is output.
- 4 Check that the number "2" is printed at the bottom of the pattern and repeat steps 2 to 3 to read the pattern.
- 5 Press [OK] in the adjustment end confirmation screen.

Drum Refresh1

Refresh the drum when image blur appear on printout copies. Takes about 85 seconds.



NOTE

Drum Refresh1 cannot be performed while printing. Execute Drum Refresh1 after the printing is done.

1 Display the screen.

- 1 Press the **[System Menu]** key.

System Menu



- 2 Press [∨], [Adjustment/Maintenance], [∨] and then [Next] of "Drum Refresh1".

2 Perform the Drum Refresh 1.

Press [Start] to perform Drum Refresh1.

Drum Refresh2

Use this mode when white spots appear on printout. Takes about 85 seconds. To use [Drum Refresh2], load Ledger or A3 size paper into the Multi Purpose tray.

When you run [Drum Refresh 2], the machine makes a vibrating sound for about 85 seconds until drum refreshing is completed. The toner soiling on the ejected paper is normal and does not indicate a fault.



NOTE

Drum Refresh2 cannot be performed while printing. Execute Drum Refresh2 after the printing is done.

1 Display the screen.

- 1 Press the **[System Menu]** key.

System Menu



- 2 Press [∨], [Adjustment/Maintenance], [∨] and then [Next] of "Drum Refresh2".

2 Perform the Drum Refresh 2.

Press [Start] to perform Drum Refresh2.

Developer Refresh

Adjust the printed image that is too light or incomplete, even though there is enough toner. In addition, Black or color dots appear on the white background when white original is scanned can be removed.

1 Display the screen.

- 1 Press the [System Menu] key.

System Menu



- 2 Press [↵], [Adjustment/Maintenance], [↵] and then [Next] of "Developer Refresh".

2 Perform the developer refresh.

Press [Start]. "Developer Refresh" begins.



NOTE

Waiting time may be longer when the toner is refilled during developer refresh.

Calibration

Calibrate the device to ensure consistency with the original grayscale. If you find that the grayscale is not improved by this calibration, use [Tone Curve Adjustment \(page 10-36\)](#).

1 Display the screen.

- 1 Press the [System Menu] key.

System Menu



- 2 Press [↵], [Adjustment/Maintenance], [↵] and then [Next] of "Calibration".

2 Perform the calibration.

Press [Start]. "Calibration" begins.

Clearing Paper Jams

If a paper jam occurs, the touch panel will display "Paper Jam." and the machine will stop. Refer to these procedures to remove the jammed paper.

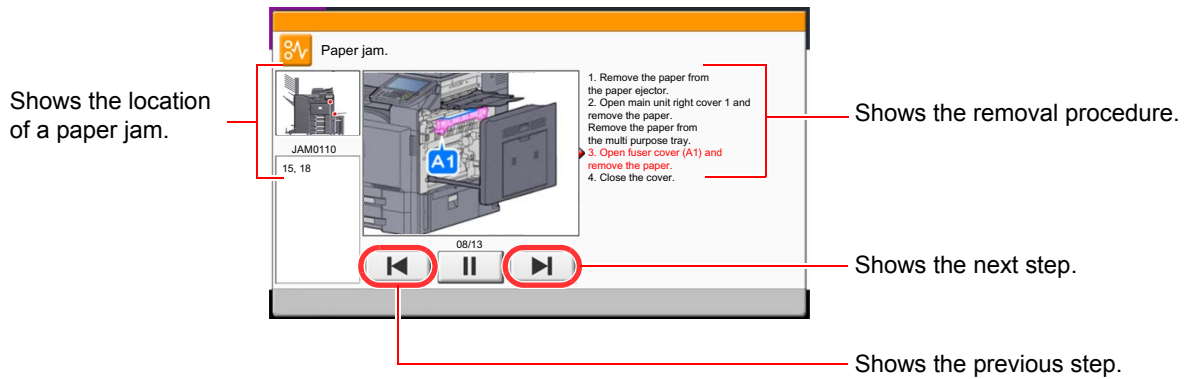

Jam Location Indicators

If a paper jam occurs, the location of the jam will be displayed on the touch panel as well as the clearing instructions.

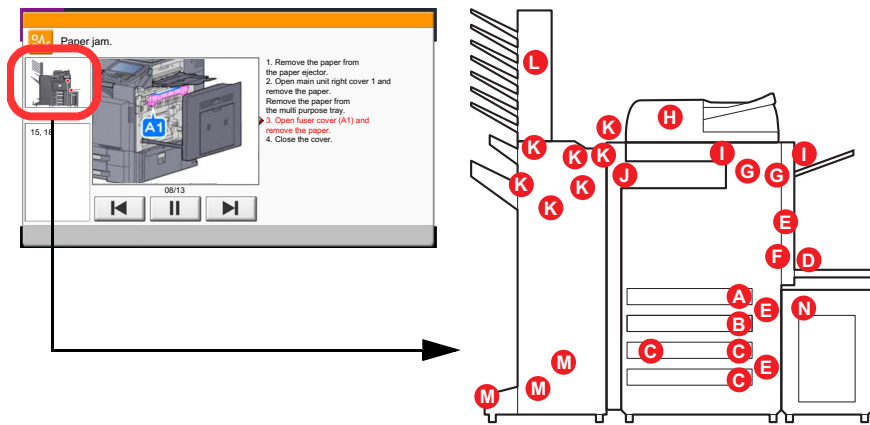

Paper Jam Location Indicator	Paper Jam Location	Reference Page
A	Cassette 1	page 10-41
B	Cassette 2	page 10-42
C	Cassette 3 or 4 (Option)	page 10-43
D	Multi Purpose Tray	page 10-46
E	Inside the right cover 1, 3 or 4	page 10-47
F	Duplex unit	page 10-48
G	Fixing unit	page 10-51
H	Document processor (Option)	page 10-52
I	Job Separator (Option)	page 10-53
J	Bridge Unit	page 10-54
K	1,000-Sheet Finisher (Option)	page 10-55
	4,000-Sheet Finisher (Option)	page 10-56
L	Mailbox (Option)	page 10-59
M	Center-Folding Unit (Option)	page 10-60
N	Cassette 5 (Option)	page 10-62

After you remove the jam, the machine will warm up again and the error message will be cleared. The machine resumes with the page that was printing when the jam occurred.

Precautions with Paper Jams

- Do not reuse jammed papers.
- If the paper tears during removal, be sure to remove any loose scraps of paper from inside the machine. Scraps of paper left in the machine could cause subsequent jamming.
- After clearing the paper jam, close the cassette and cover in the reverse procedure.
- Discard paper that has jammed in the optional document finisher (1,000-Sheet Finisher or 4,000-Sheet Finisher). A page affected by a paper jam will be printed again.



CAUTION

The fixing unit is extremely hot. Take sufficient care when working in this area, as there is a danger of getting burned.

Cassette 1

1

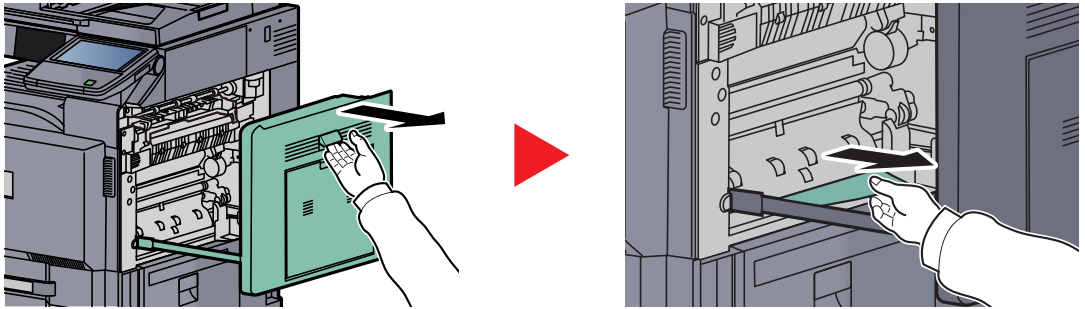

2

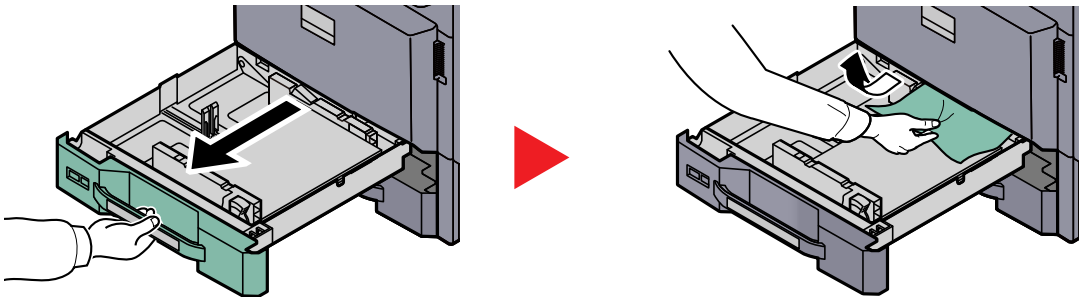

NOTE

To remove paper which is difficult to get access to, the inner part of the cassette can be removed.

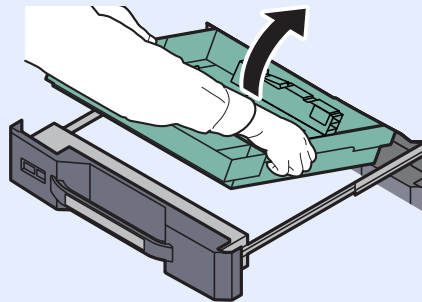

Cassette 2

1

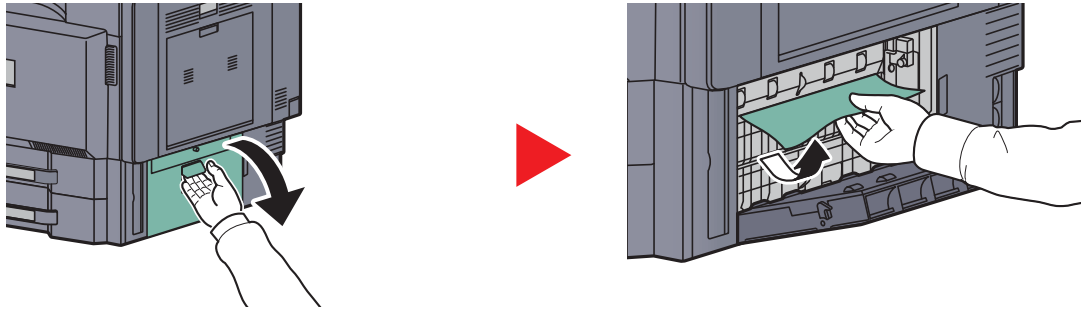

2

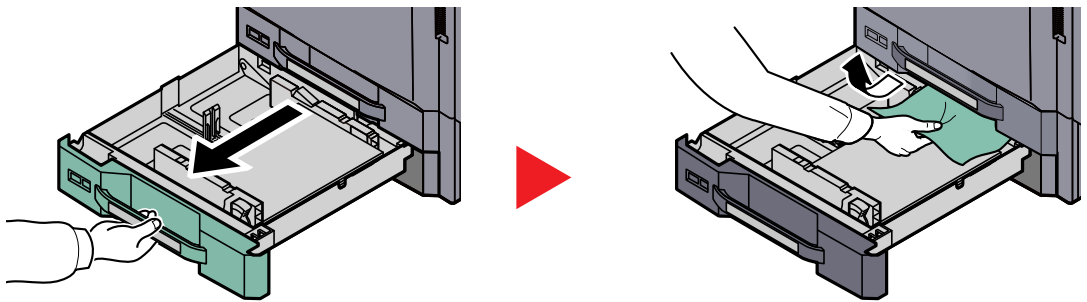

NOTE

To remove paper which is difficult to get access to, the inner part of the cassette can be removed.

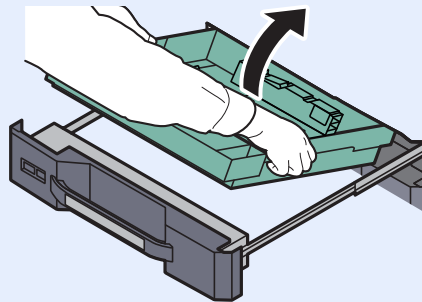

Optional Cassettes 3 and 4

Paper Feeder (500-sheet x 2)

1

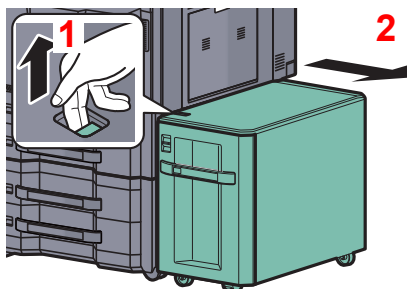

2

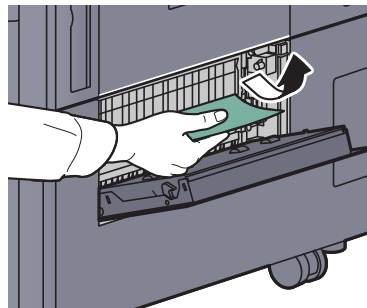
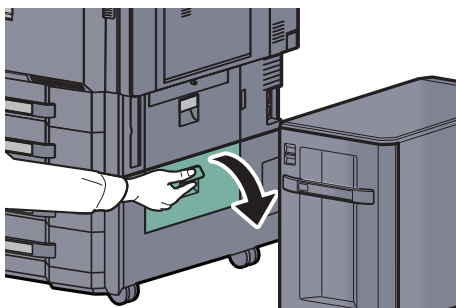

3

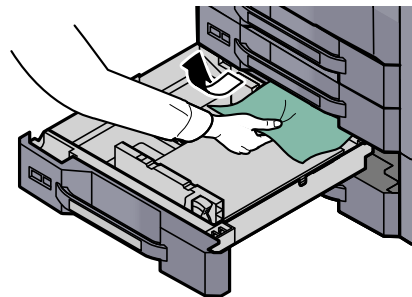
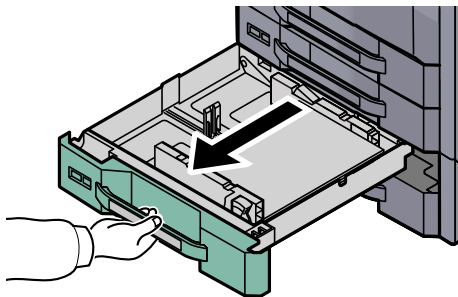



NOTE

To remove paper which is difficult to get access to, the inner part of the cassette can be removed.

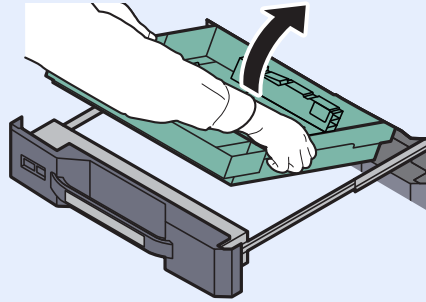

Large Capacity Feeder (1,500-sheet x 2)

1

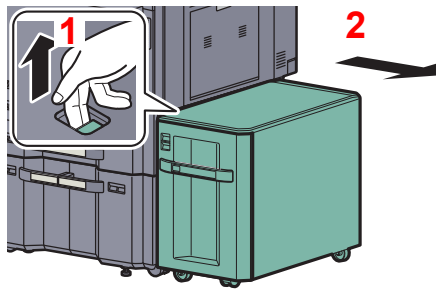

2

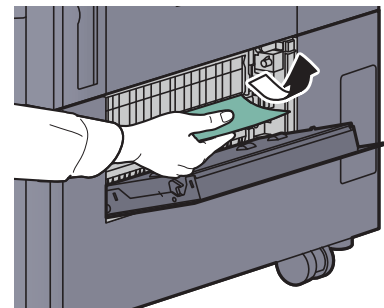

3

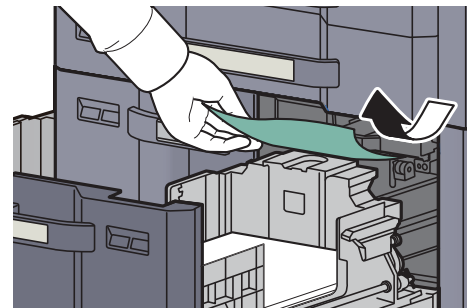
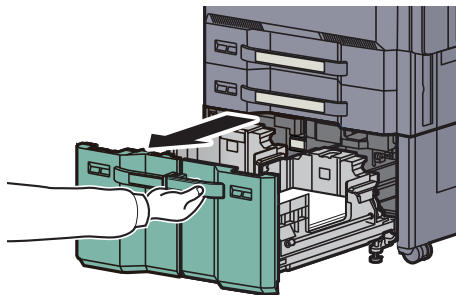

4

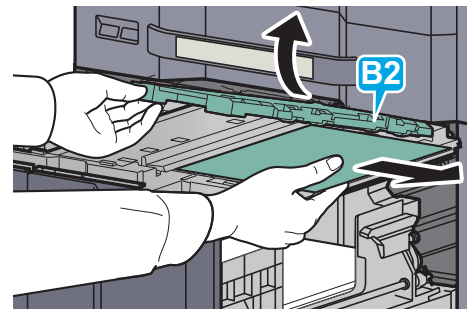
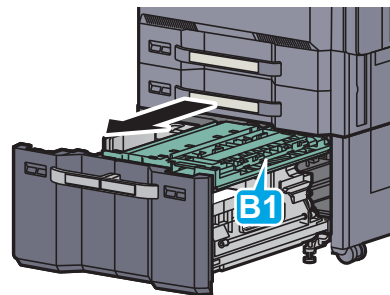

Multi Purpose Tray

1

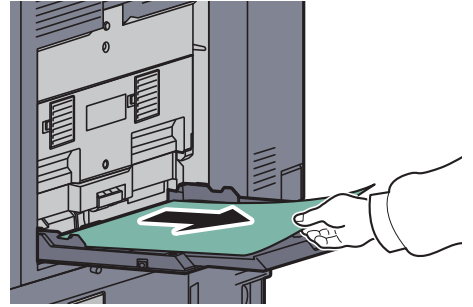
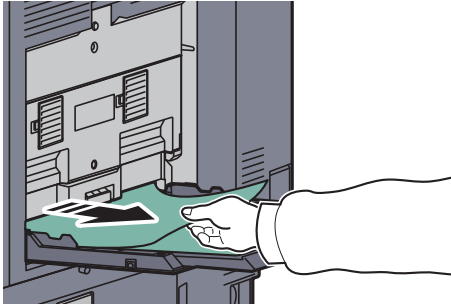

2

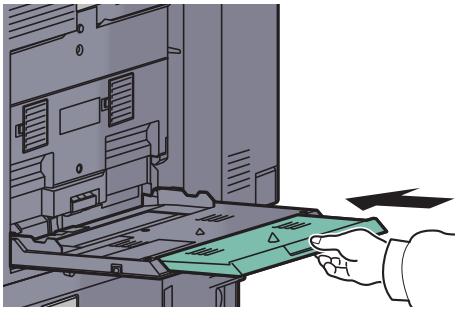

3

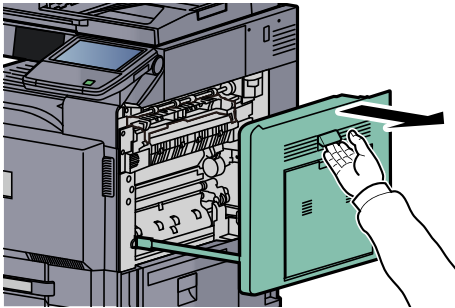

4

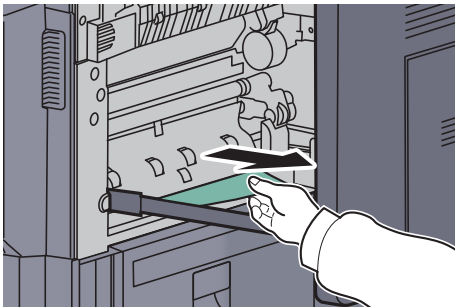

Inside the Right Covers 1, 3 and 4

1

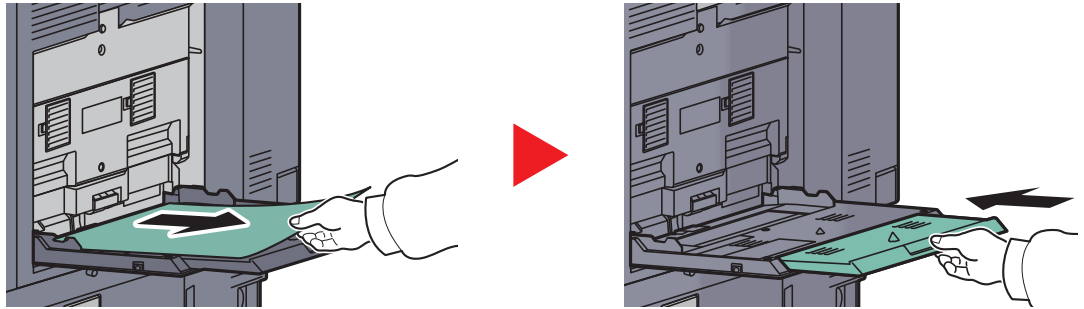

2

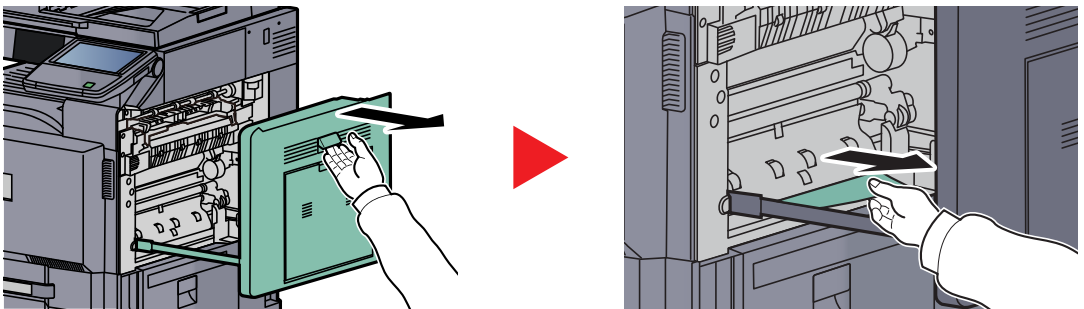

If you are using the optional document finisher, follow step on page 10-54 to remove jammed paper in the optional bridge unit.

Duplex unit

1

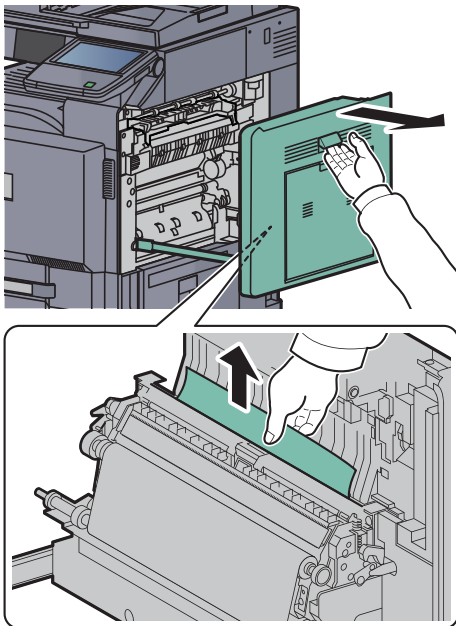

2

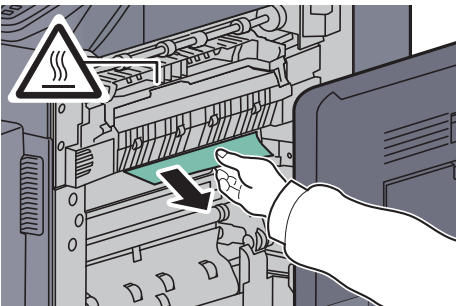

Duplex Unit and Cassette 1

1

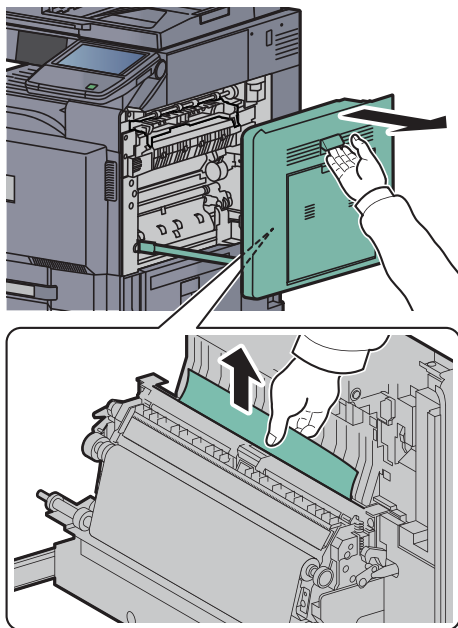

2

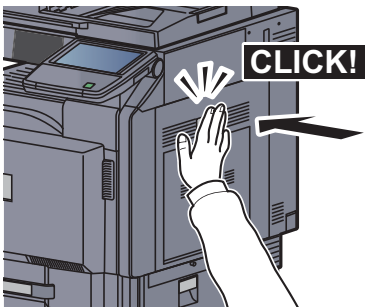

3

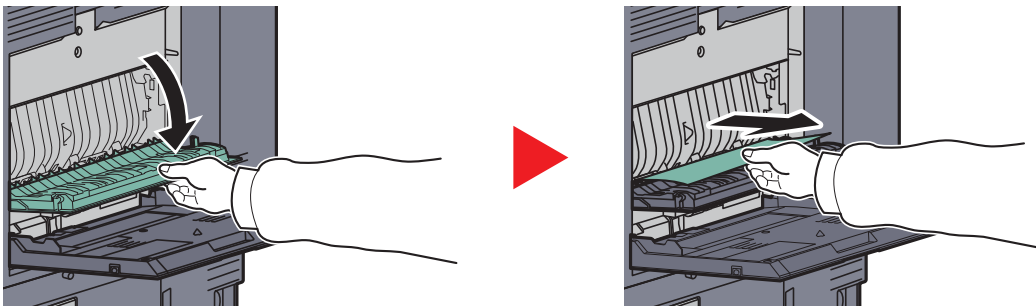

4

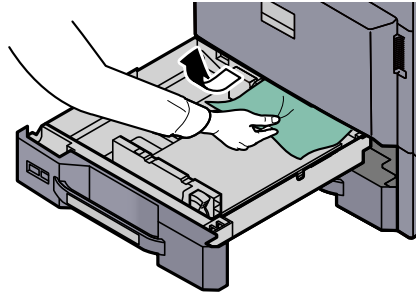

NOTE

To remove paper which is difficult to get access to, the inner part of the cassette can be removed.

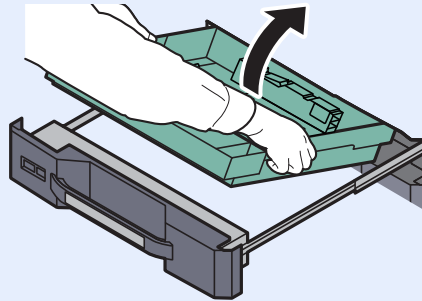

Fixing unit

1

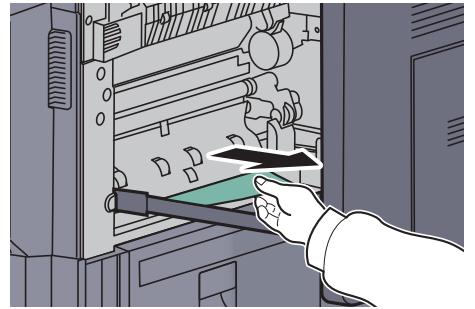
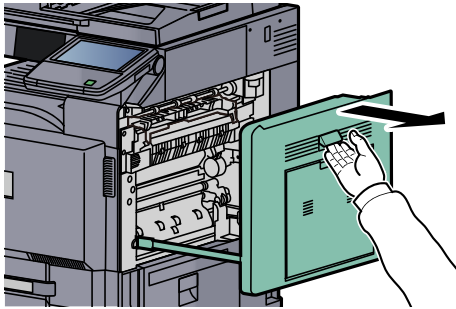

2

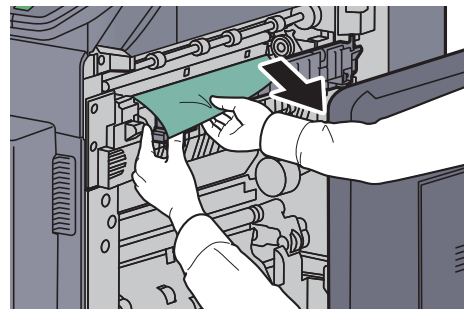
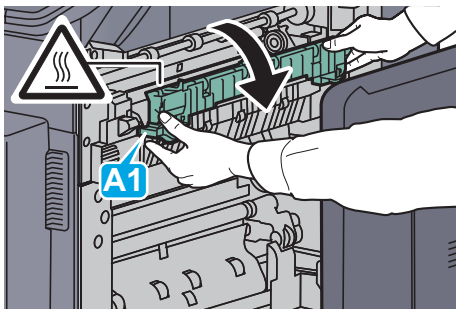

3



Optional Document Processor

1

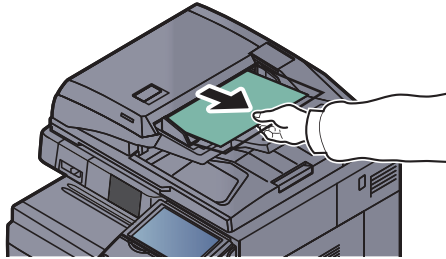

2

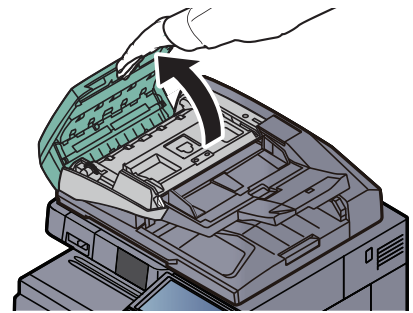
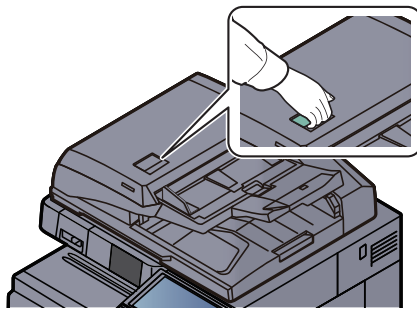

3

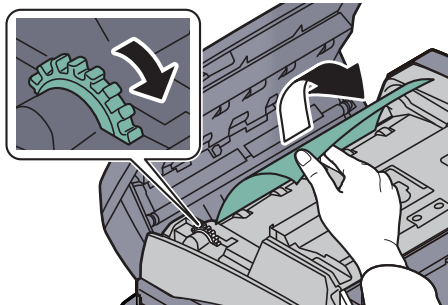

If the original is difficult to remove, turn the dial. The original will scroll out to a position where it can be removed easily.

If you are using the document processor (Automatic 2-Sided), go to step 4.

4

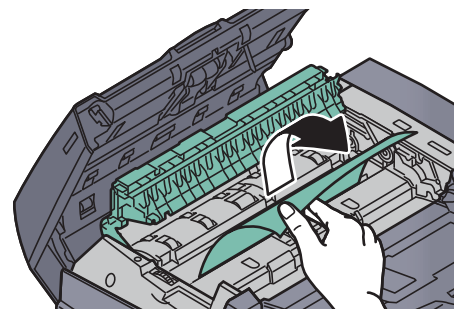
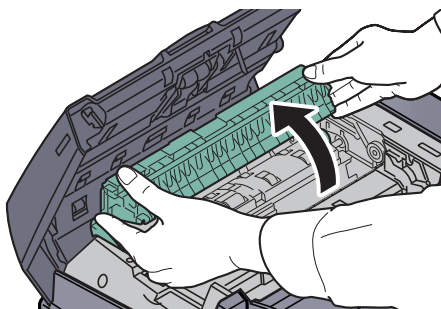

Optional Job Separator

Inner Job Separator

1

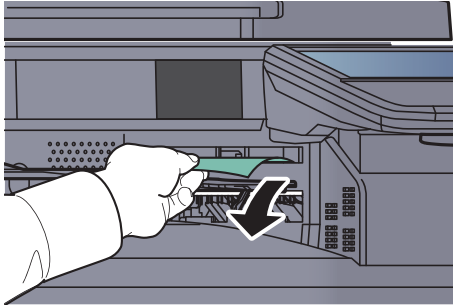

2

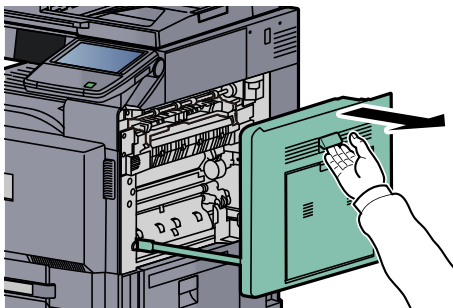

3

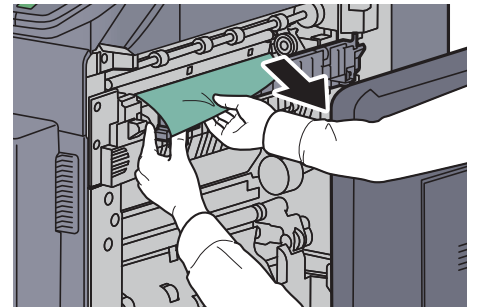
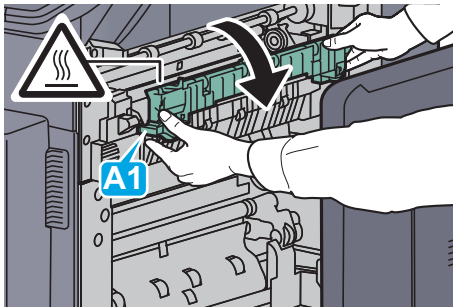

Right Job Separator

1

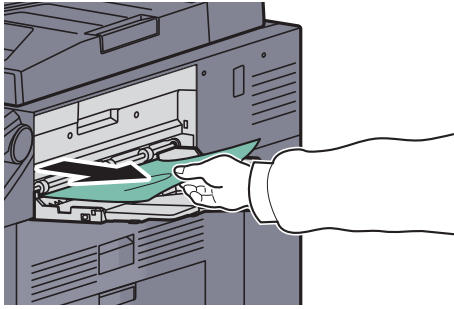

2

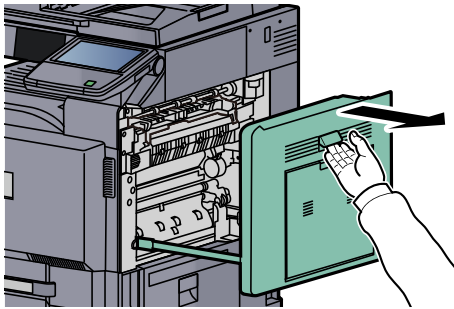

3

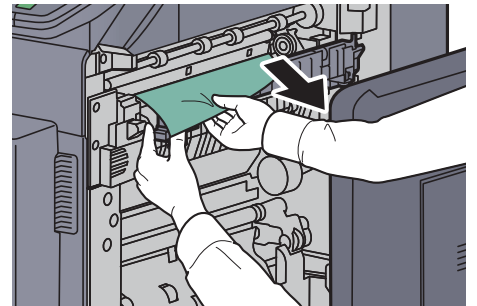
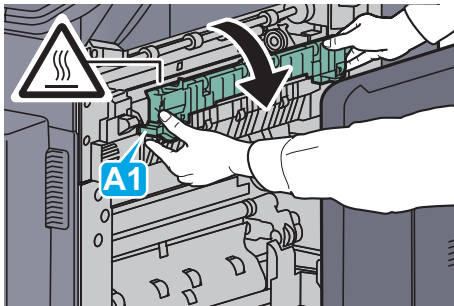

Bridge Unit (Option)

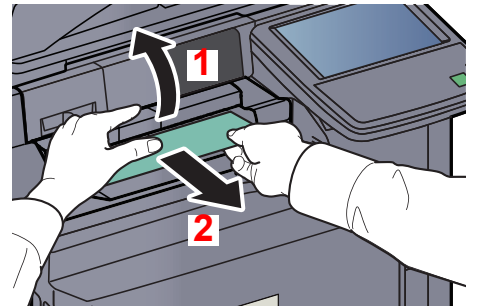

1,000-Sheet Finisher (Option)

1

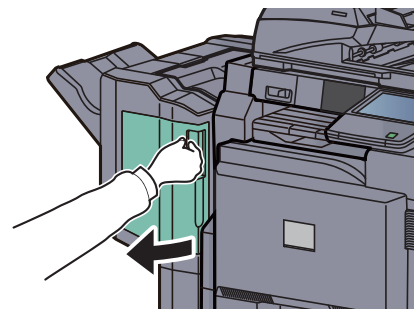
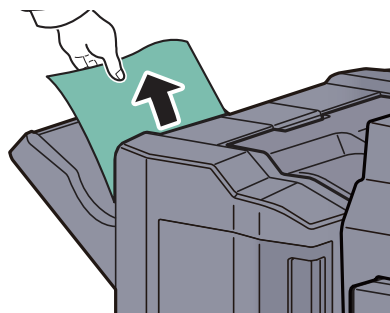

2

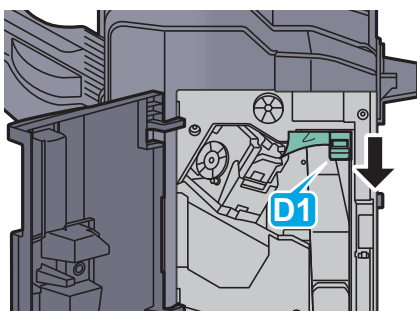

3

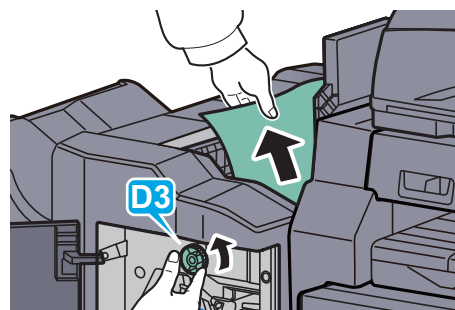
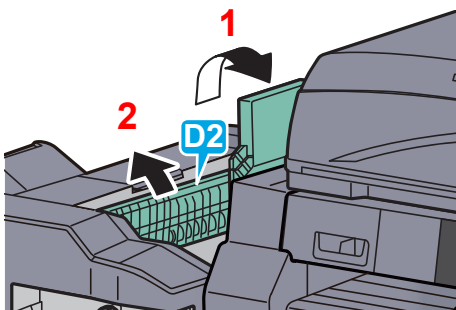

4,000-Sheet Finisher (Option)

Coupling Section

1

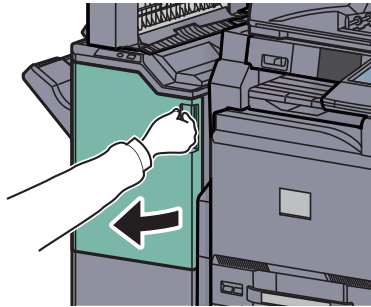

2

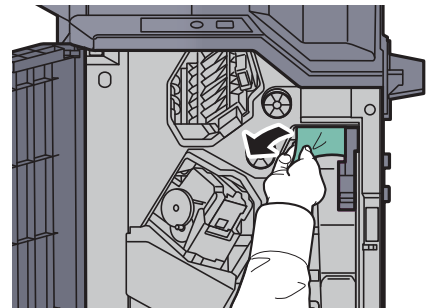
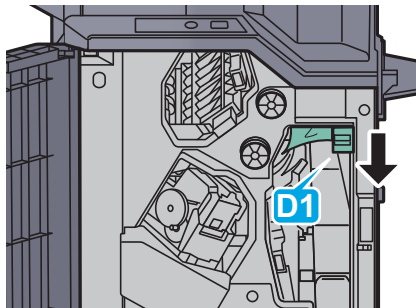

Tray A

1

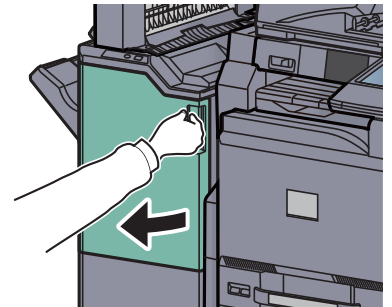
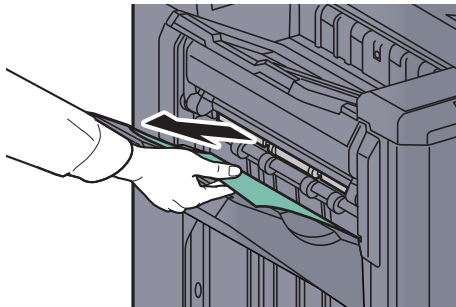

2

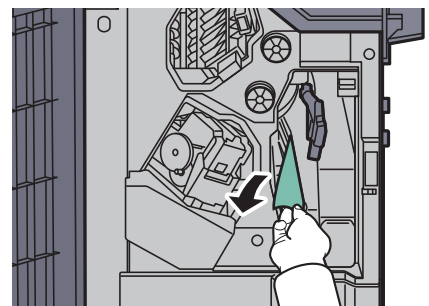
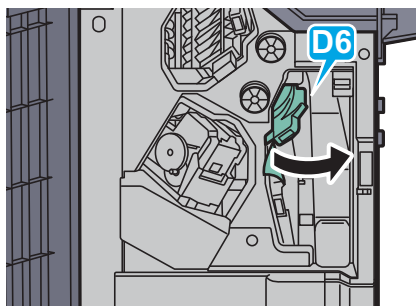

3

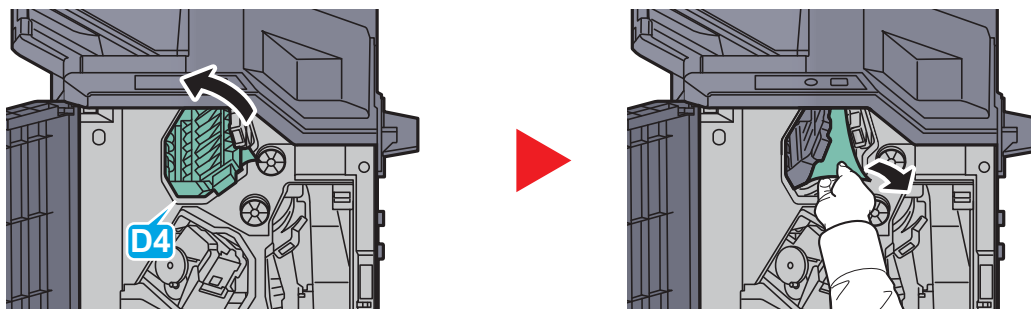

NOTE

If it is difficult to remove the jammed paper, turn feed knob D3 until the jammed paper is in a location where it is easy to remove.

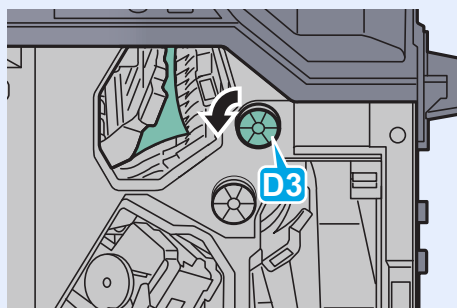

Tray B

1

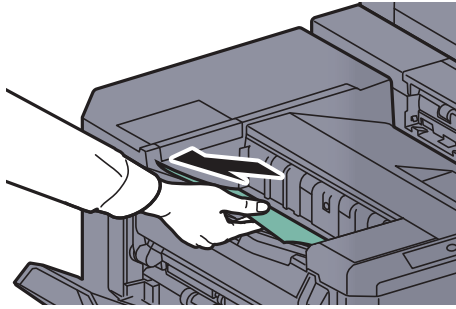

2

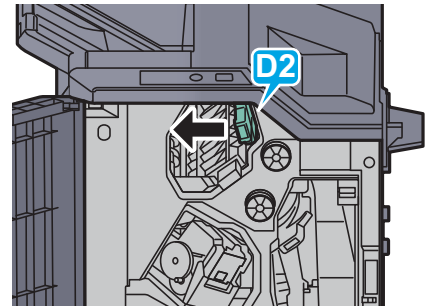
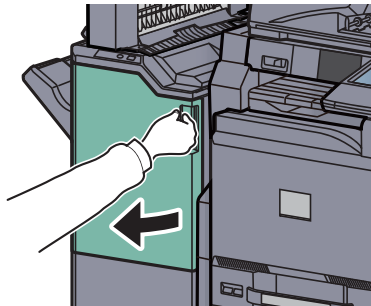

3

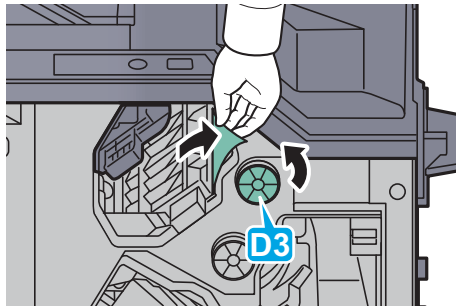

Tray C

1

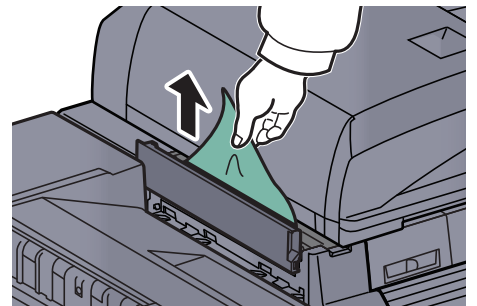
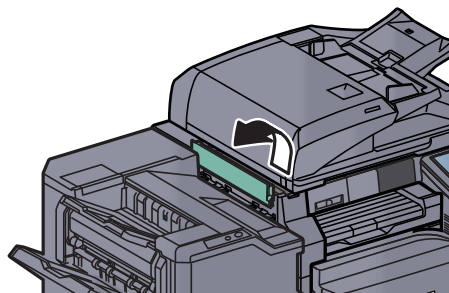

Conveyor

1

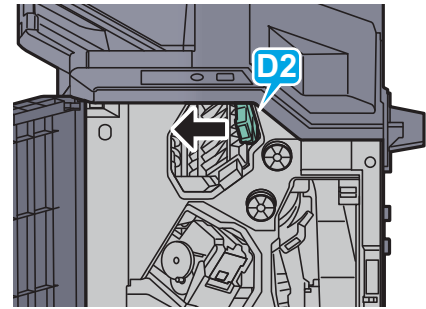
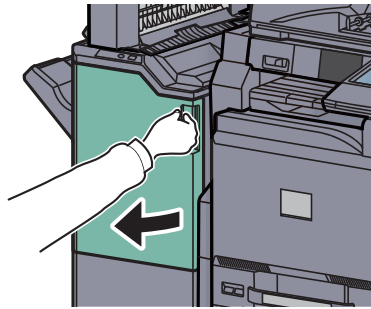

2

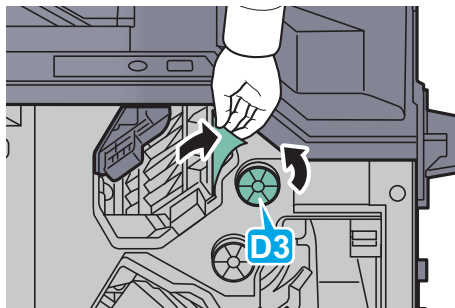

Mailbox (Option)

1

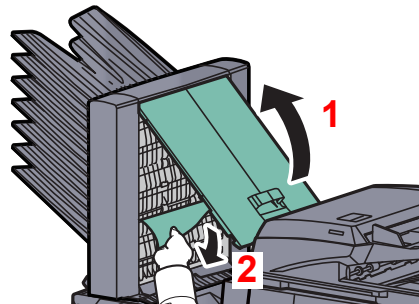

Center-Folding Unit (Option)

Ejection Section

1

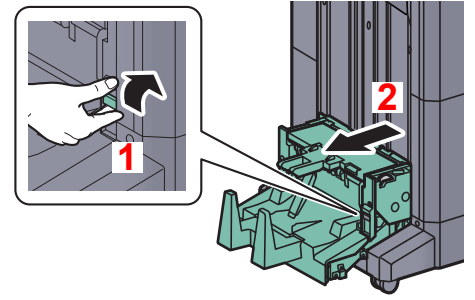
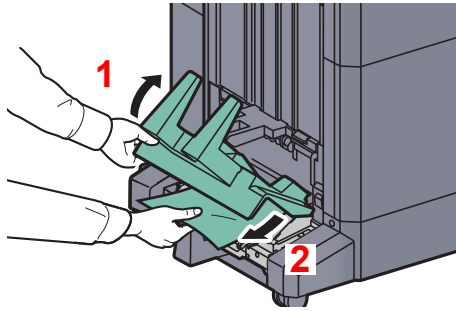

2

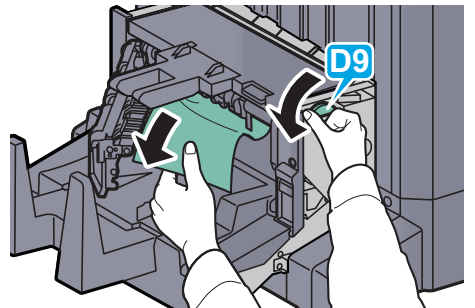
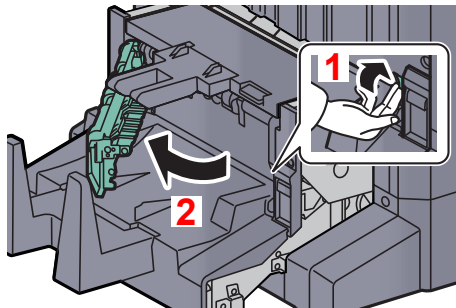

3

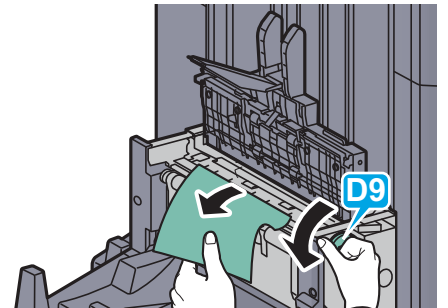
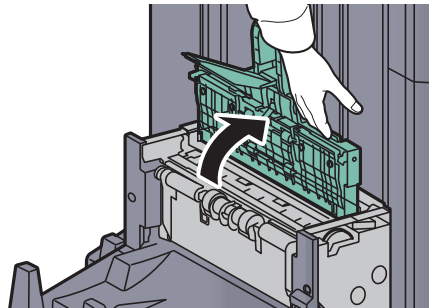

Conveyor Section

1

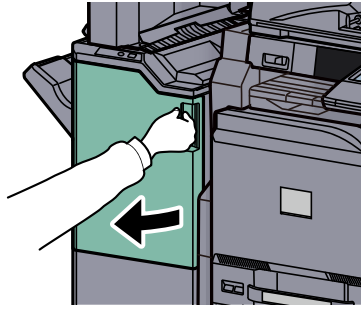

2

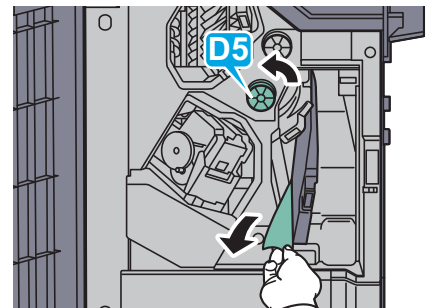
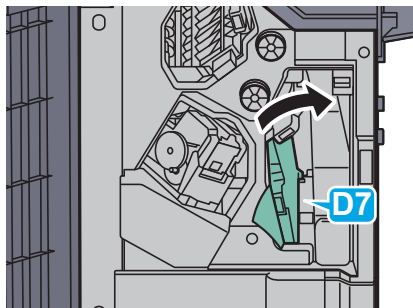

If there is no paper jam in the conveyor guide (D7), proceed to the following step.

3



4

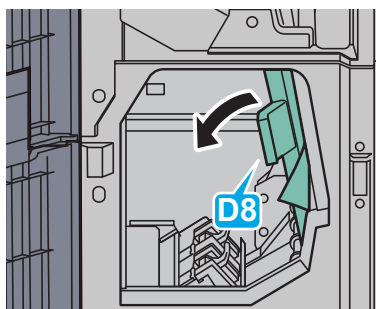

5



Cassette 5 (Option)

1

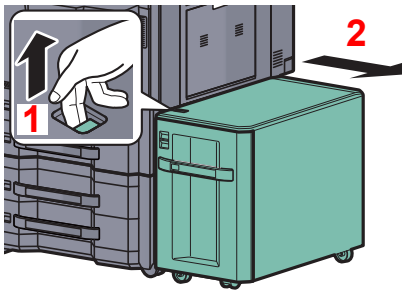

2

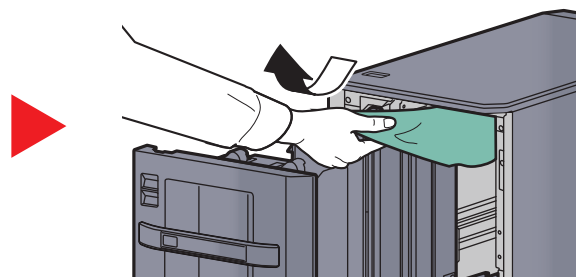
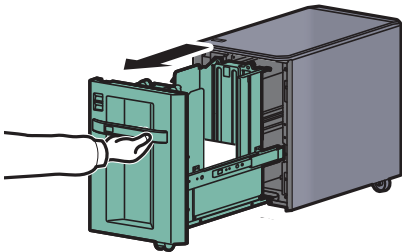

Clearing a Staple Jam

1,000-Sheet Finisher

1

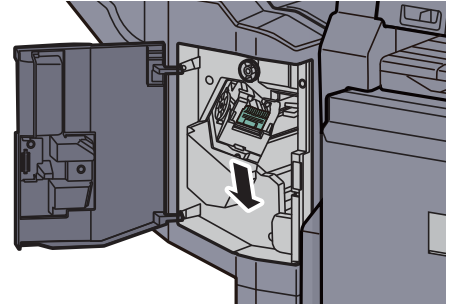
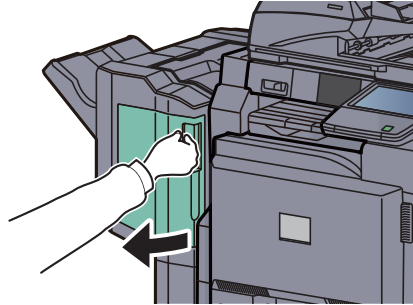

2

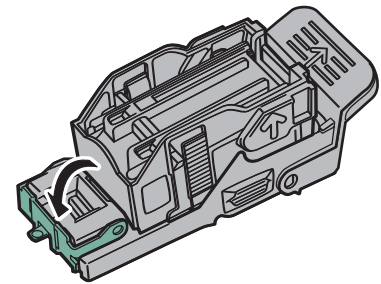
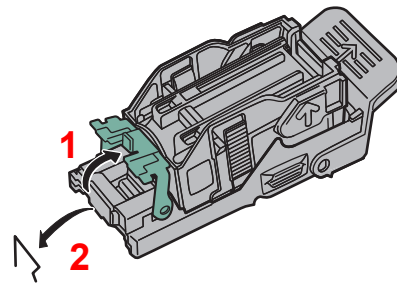

3

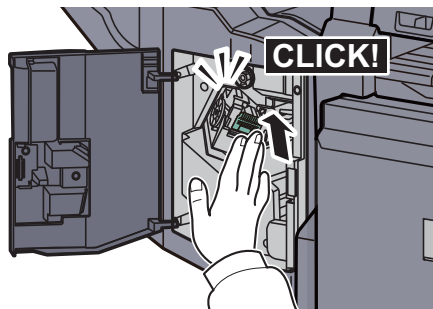

4,000-Sheet Finisher

Staple cartridge holder A

1

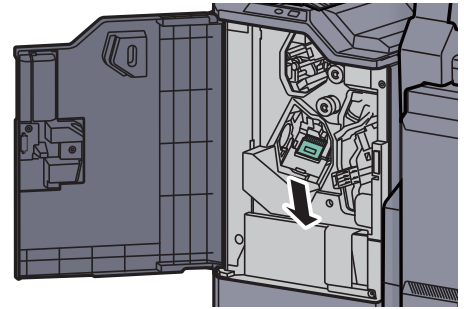
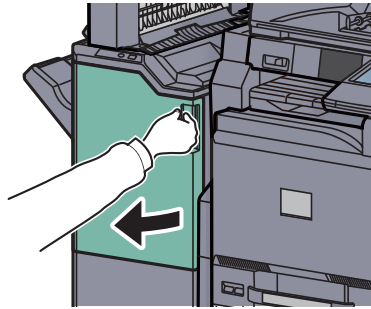

2

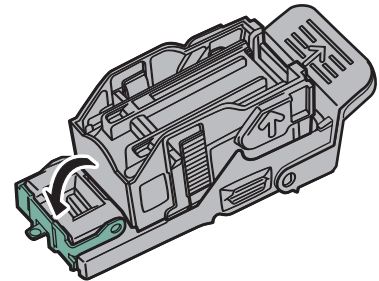
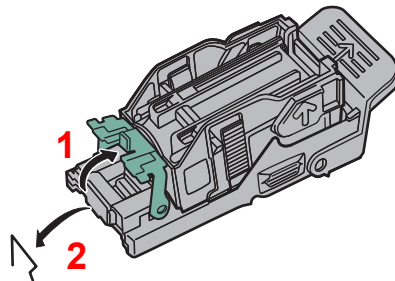

3

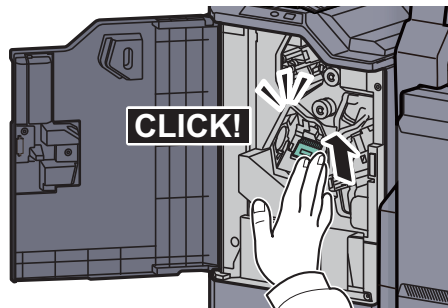

Staple cartridge holder B/C

1

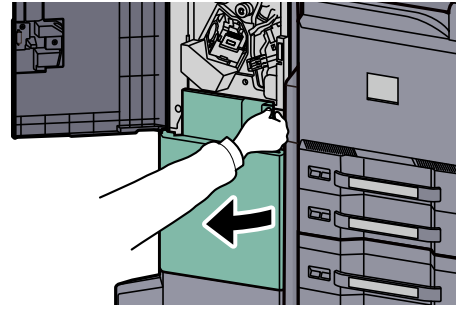
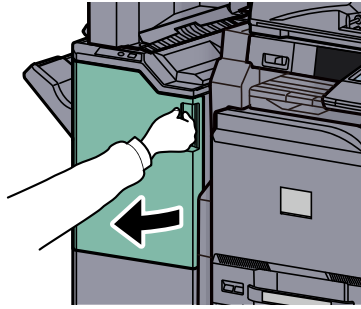

2

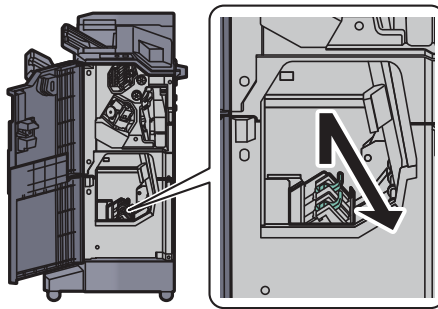

3

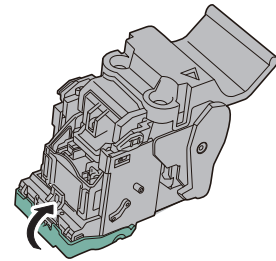
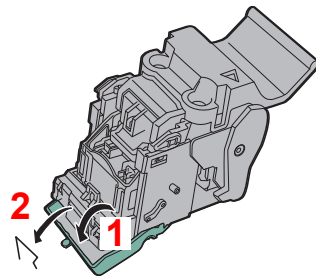

4

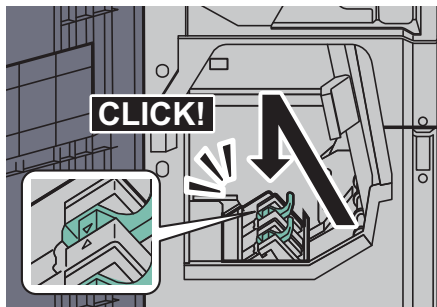

11 Appendix

This chapter explains the following topics:

Optional Equipment	11-2
Overview of Optional Equipment	11-2
Optional Applications	11-8
Character Entry Method	11-10
Entry Screens	11-10
Entering Characters	11-12
Paper	11-13
Basic Paper Specifications	11-13
Choosing the Appropriate Paper	11-14
Special Paper	11-17
Specifications	11-22
Common functions	11-22
Copy functions	11-24
Printer functions	11-25
Scanner functions	11-25
Document Processor (Option)	11-26
Paper Feeder (500-sheet x 2) (Option)	11-26
Large Capacity Feeder (1,500-sheet x 2) (Option)	11-27
Side Feeder (3,000-sheet) (Option)	11-27
1,000-Sheet Finisher (Option)	11-28
4,000-Sheet Finisher (Option)	11-29
Hole Punch Unit (Option)	11-29
Mailbox (Option)	11-30
Center-Folding Unit (Option)	11-30
Inner Job Separator (Option)	11-31
Inner Job Separator (JS-732) (Option)	11-31
Right Job Separator (Option)	11-32
Banner Tray (Option)	11-32
Glossary	11-33

Optional Equipment

Overview of Optional Equipment

The following optional equipment is available for the machine.

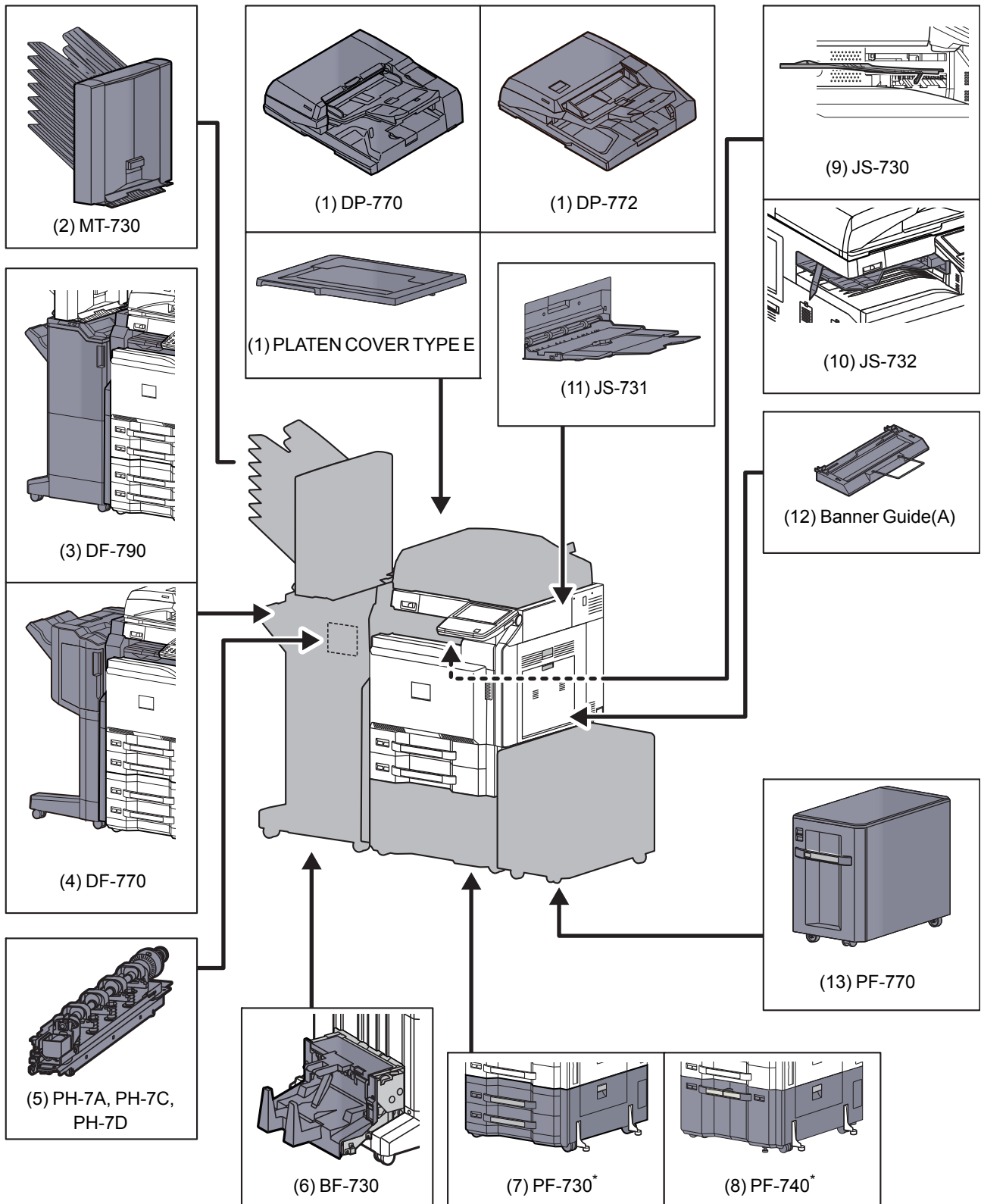

* If neither a document finisher nor a side feeder is installed, the toppling prevention kit must be installed.

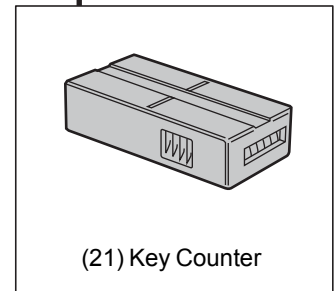
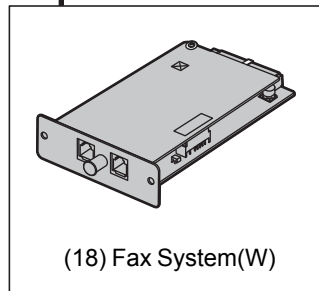
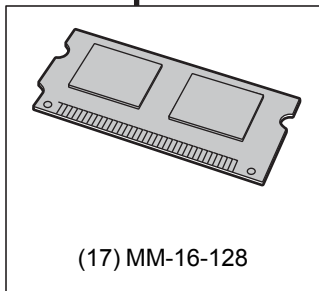
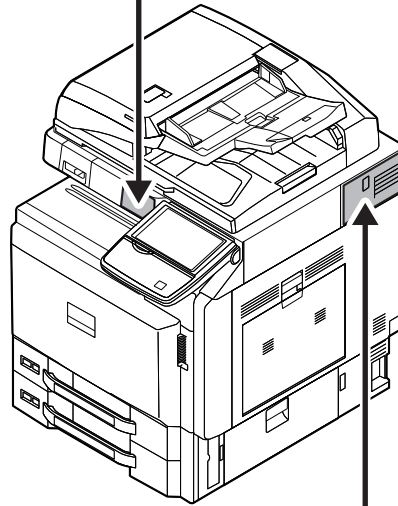
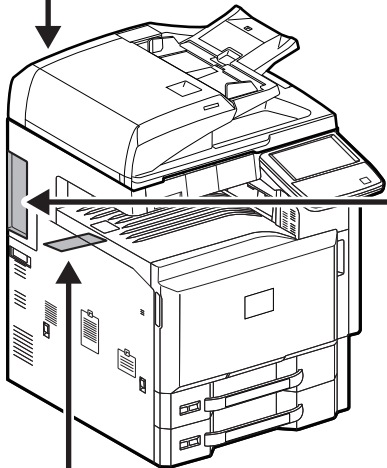
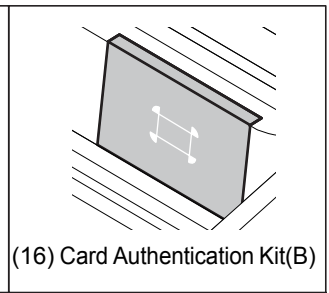
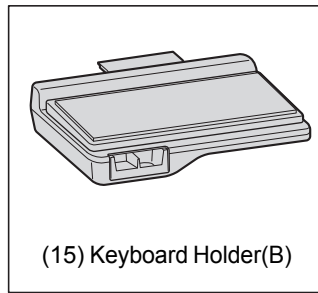
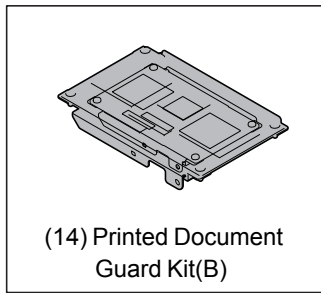

Software option
(23) Internet FAX Kit(A)
(24) Data Security Kit(E)
(25) UG-33
(26) UG-34
(27) Scan extension kit(A)
(28) USB Keyboard

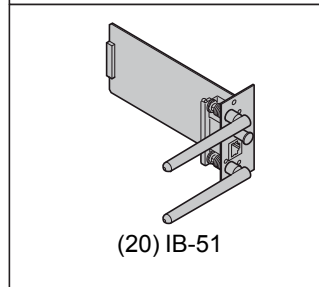
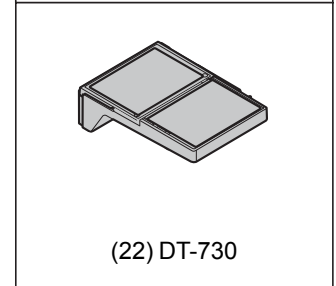
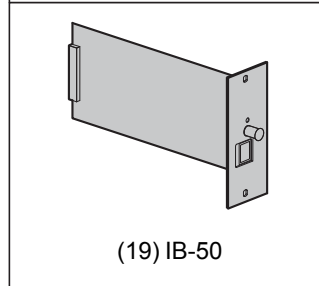

**(1) DP-770 "Document Processor (Reverse Automatic)"
DP-772 "Document Processor (Dual Scan)"
PLATEN COVER TYPE E "Platen"**

Automatically scans originals. Also you can perform duplex copying and split copying.
For document processor operation, refer to [Loading Originals in the Document Processor on page 5-3](#).
When the document processor is not used, please use the PLATEN COVER TYPE E.

(2) MT-730 "Mailbox"

Makes it easy to sort output into separate trays. Installing this option adds 7 output trays. When multiple computer users share the printer, each user can print to a specified tray. Installs on the 4,000-Sheet Finisher.

 **NOTE**

To deliver output to the mail box, change the Paper Output selection on the operation panel or in the printer driver, or change in the default settings. (For details, refer to [Paper Output on page 6-21](#).)

(3) DF-790 "4,000-Sheet Finisher"

This is a large-capacity 4,000-Sheet Finisher capable of holding large print runs and of separating and offsetting multiple copies of a printout into individual copies. It can also staple or hole-punch (optional) the offset printouts. User can select manual staple by operation button. A mail box and folding unit are also available as options.

(4) DF-770 "1,000-Sheet Finisher"

This is a document finisher capable of holding large print runs and of separating and offsetting multiple copies of a printout into individual copies. It can also staple or hole-punch (optional) the offset printouts.

(5) PH-7A, PH-7C, PH-7D "Hole Punch Unit"

Attaches to the Document Finisher and is used to punch holes.

(6) BF-730 "Folding Unit"

Folds printed output at the center or in tri-fold to enable the creation of simple booklets. Installs on the 4,000-Sheet Finisher.

(7) PF-730 "Paper Feeder (500-sheet x2)"

Two additional cassettes identical to the printer's cassette can be installed in the printer. Paper capacity and loading method are the same as the standard cassettes. Refer to [Standard cassettes on page 3-18](#) for loading paper.

(8) PF-740 "Large Capacity Feeder (1,500-sheet x 2)"

In addition to the printer's cassettes, you can also install an optional large capacity feeder (1,500-sheet x 2) capable of holding up to 3,000 sheets of A4, B5 or Letter paper. Refer to [The Large Capacity Feeder \(1,500-sheet x 2\) \(Option\) on page 3-21](#) for loading paper.

(9) JS-730 "Inner Job Separator"

Separate paper according to output tray for easier sorting. Specify as the output tray for copy or print jobs. Or, specify as the default output tray for printing from the copy or Document Box screen, printing from the PC, and printing of the received fax data.

✔ IMPORTANT

Note that some paper types have a tendency to curl and may jam in the paper eject unit.

If the ejected paper slips or stacks unevenly, turn the paper in the cassette over and try again.

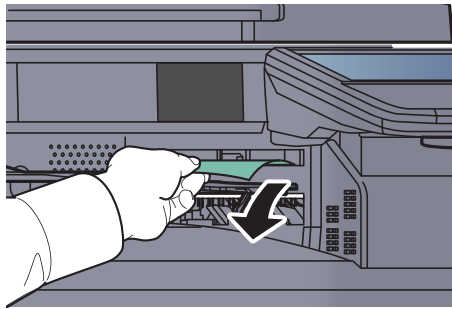

💡 NOTE

To ensure that paper is delivered to the Inner Job Separator, select the output destination or change the default setting. (For details, refer to the [Paper Output on page 6-21.](#))

(10) JS-732 "Inner Job Separator (JS-732)"

Separate paper according to output tray for easier sorting. Specify as the output tray for copy or print jobs. Or, specify as the default output tray for printing from the copy or Document Box screen, printing from the PC, and printing of the received fax data.

✔ IMPORTANT

Note that some paper types have a tendency to curl and may jam in the paper eject unit.

If the ejected paper slips or stacks unevenly, turn the paper in the cassette over and try again.

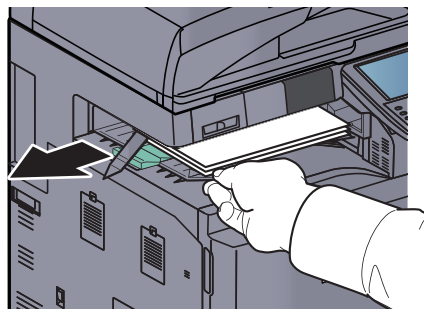

💡 NOTE

- To ensure that paper is delivered to the Inner Job Separator (JS-732), select the output destination or change the default setting. (For details, refer to the [Paper Output on page 6-21.](#))
- If the paper is A3, B4, Ledger, or Legal, pull out the auxiliary tray.
- The busy light stays on until the output is removed from the Inner Job Separator (JS-732).

(11) JS-731 "Right Job Separator"

Separate paper according to output tray for easier sorting. Specify as the output tray for copy or print jobs. Or, specify as the default output tray for printing from the copy or Document Box screen, printing from the PC, and printing of the received fax data.

(12) Banner Guide(A) "Banner Tray"

This tray enables continuous feeding of banner paper. Up to 10 sheets of banner paper can be loaded. To attach the tray and load paper, refer to [Using the Banner Tray \(Option\) on page 4-10](#).

(13) PF-770 "Side Feeder (3,000-sheet)"

In addition to the printer's cassettes, you can also install an optional side feeder (3,000-sheet) capable of holding up to 3,000 sheets of A4, B5 or Letter paper. Refer to [Side Feeder \(3,000-sheet\) \(Option\) on page 3-25](#) for loading paper.

(14) Printed Document Guard Kit(B) "Printed Document Guard Kit"

This prevents the unauthorized copying and/or transmission of documents that contain important confidential or personal information. When a document is printed from a computer, this feature imprints a special pattern on the document. When anyone attempts to copy or send that document on this machine, the machine detects the pattern and protects the information by printing the document in blank and prohibiting transmission.

(15) Keyboard Holder(B) "Keyboard Holder"

A USB keyboard connected to the machine can be placed here.

(16) Card Authentication Kit(B) "Card Authentication Kit"

User login administration can be performed using ID cards. To do so, it is necessary to register ID card information on the previously registered local user list. For more information about how to register this information, refer to the **Card Authentication Kit(B) Operation Guide**.

(17) MM-16-128 "FAX Expansion Memory"

Image storage memory (128 MB) that allows the machine to receive more pages of incoming faxed originals. Expansion memory should only be installed or removed by the service representative.

(18) Fax System(W) "FAX Kit"

By installing the FAX kit, fax send/receive is enabled. Also, it is possible to use it as a network fax, by using it with a computer. When two FAX kits are installed, the units can be connected to two different telephone lines which will enable quicker message transmission to a number of recipients. If one of the lines is dedicated to receiving, the busy line time can be reduced. For further details, refer to **FAX Operation Guide**.

(19) IB-50 "Network Interface Kit"

The Network Interface Kit provides a high-speed connection for the Gigabit-per-second interface. Since the kit was designed to work with TCP/IP, NetWare, NetBEUI, and AppleTalk protocols, it fulfills the network printing demands on Windows, Macintosh, and UNIX environments. This expansion kit is also compatible with ThinPrint.

(20) IB-51 "Wireless Network Interface Kit"

This is a wireless LAN interface card which supports the wireless LAN specifications IEEE802.11n (Max 300 Mbps) and 11 g/b. With the utilities supplied, settings are possible for a variety of OS and network protocols.

(21) Key Counter "Key Counter"

Use the key counter to monitor machine usage. The key counter offers a convenient solution for centralized management of copy volume for different departments in a large company.

Inserting the Key Counter

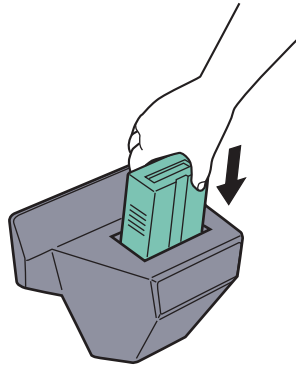

Insert the key counter securely into the key counter slot.

NOTE

When the key counter function is activated, copies can only be made when a key counter is inserted. If the key counter is not inserted, "Insert the key counter." will be displayed.

(22) DT-730 "Document Table"

Place original or other documents when using the machine. It has a drawer to accommodate clips.

(23) Internet FAX Kit(A) "Internet FAX Kit"

Activating the Internet FAX Kit sends and receives faxes via the Internet without using a phone line. It can only be added when the FAX Kit is installed.

(24) Data Security Kit(E) "Data Security Kit"

The Data Security Kit overwrites all unnecessary data in the storage area of the hard disk so that it cannot be retrieved. The Data Security Kit encrypts data before storing it in the hard disk. It guarantees higher security because no data cannot be decoded by ordinary output or operations.

(25) UG-33 "ThinPrint Option"

This application allows print data to be printed directly without a print driver.

(26) UG-34 "Emulation Upgrade Kit"

Enables emulation whereby the machine operates using commands for other printers. Installing this option enables IBM Proprinter, Line Printer, and EPSON LQ-850 emulation.

(27) Scan extension kit(A) "OCR Scan Activation Kit"

This option enables the use of the OCR function in the applications of the machine.

(28) USB Keyboard "USB Keyboard"

A USB keyboard can be used to enter information into the text fields on the operation panel. A special mount is also available to install the keyboard on the MFP. Please contact your dealer or service representative for information on keyboards that are compatible with your MFP before you purchase one.

Optional Applications

Overview of the Applications

The applications listed below are installed on this machine.

Application
Data Security Kit
Internet FAX Kit
Card Authentication Kit
ThinPrint Option*
Emulation Upgrade Kit
OCR Scan Activation Kit*

* This can be used on a trial basis for a limited time.

NOTE

Restrictions such as the number of times the application can be used during the trial period differ depending on the application.

If you change the date/time while using the trial version of an application, you will no longer be able to use the application.

Starting Application Use

Use the procedure below to start using an application.

- 1 Press the **[System Menu]** key.

System Menu



- 2 Press [System/Network], [Next] of "Optional Function".

NOTE

If the user authentication screen appears, enter your login user name and login password and press [Login]. For this, you need to login with administrator privileges. The factory default login user name and login password are set as shown below.

Model Name	Login User Name	Login Password
3501i	3500	3500
4501i	4500	4500
5501i	5500	5500

- 3 Select the desired application and press [Activate].

You can view detailed information on the selected application by pressing [Detail].

- 4 Press [Official] in the license key entry screen.

Some applications do not require you to enter a license key. If the license key entry screen does not appear, go to Step 5.

To use the application as a trial, press [Trial] without entering the license key.

- 5 Press [Yes] in the confirmation screen.



NOTE

Icons of activated application are displayed in the Home screen.

Checking Details of Application

Use the procedure below to check the details of application.

- 1 Press the [System Menu] key.

System Menu



- 2 Press [System/Network], and [Next] of "Optional Function".



NOTE

If the user authentication screen appears, enter your login user name and login password and press [Login]. For this, you need to login with administrator privileges. The factory default login user name and login password are set as shown below.

Model Name	Login User Name	Login Password
3501i	3500	3500
4501i	4500	4500
5501i	5500	5500

- 3 Select the desired application and press [Detail].

You can view detailed information on the selected application.

Character Entry Method

To enter characters for a name, use the on-display keyboard in the touch panel following the steps as explained below.

NOTE

Keyboard Layout

"QWERTY", "QWERTZ" and "AZERTY" are available as keyboard layouts the same as a PC keyboard. Press the [System Menu] key, [Common Settings] and then [Change] of "Keyboard Layout" to choose the desired layout. "QWERTY" layout is used here as an example. You may use another layout following the same steps.

Entry Screens

Lower-case Letter Entry Screen

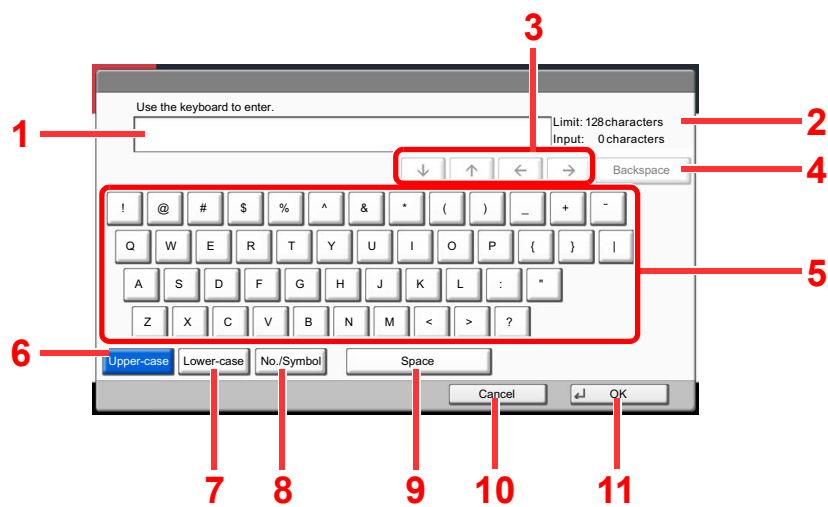

No.	Display/Key	Description
1	Display	Displays entered characters.
2	Limit Display	Displays maximum number of characters.
3	Cursor Key	Press to move the cursor on the display.
4	[Backspace]	Press to delete a character to the left of the cursor.
5	Keyboard	Press a character to enter.
6	[Upper-case]	Press to use upper-case letters.
7	[Lower-case]	Press to use lower-case letters.
8	[No./Symbol]	Press to enter numbers and symbols.
9	[Space]	Press to insert a space.
10	[Cancel]	Press to cancel entered characters and return to the screen before the entry.
11	[OK]	Press to finalize entry and return to the screen before the entry.

Upper-case Letter Entry Screen

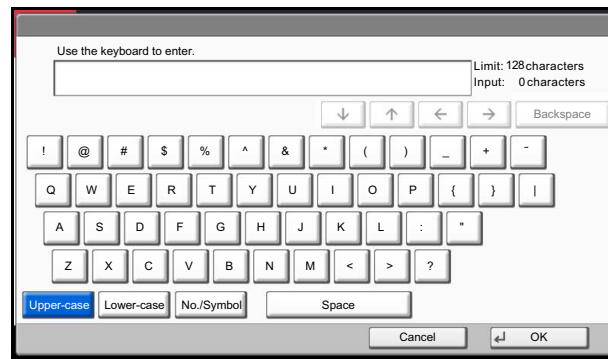

Number/Symbol Entry Screen

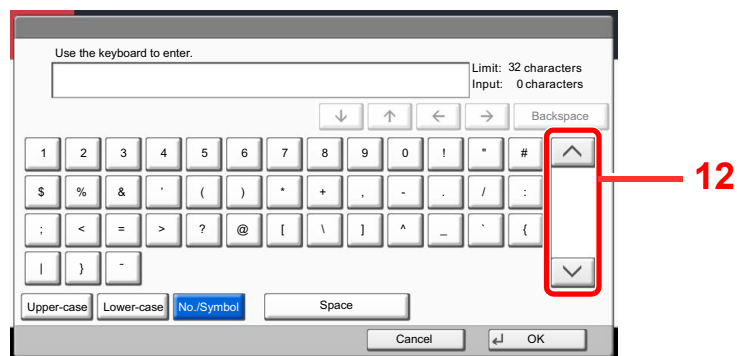

No.	Display/Key	Description
12	[^]/[v]	To enter a number or symbol not shown in the keyboard, press the cursor key and scroll the screen to view other numbers or symbols to enter.

Entering Characters

Follow the steps shown below to enter "List A-1" for example.

- 1 Press [Upper-case].
- 2 Press [L]. The letter "L" is shown on the display.

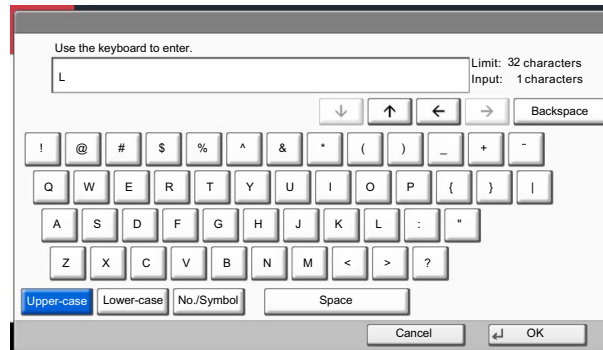

- 3 Press [Lower-case].
- 4 Press [i], [s], [t] and [Space].

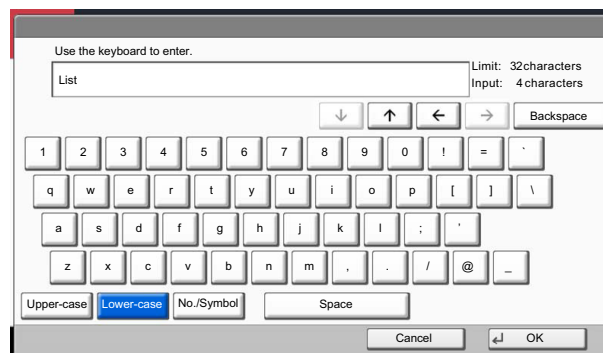

- 5 Press [Upper-case].
- 6 Press [A].
- 7 Press [No./Symbol].
- 8 Press [^] or [v] repeatedly to view the keyboard containing [-] and [1].
- 9 Press [-] and [1].

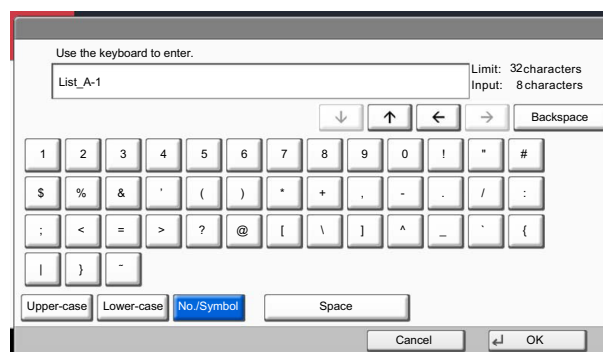

- 10 Check that the entry is correct. Press [OK].

Paper

This section explains the paper sizes and types that can be used in the paper source.

 For details on the sizes, types, and number of sheets of paper that can be loaded in each paper tray, refer to [Specifications on page 11-22](#).

Basic Paper Specifications

This machine is designed to print on standard copy paper as used in regular ('dry') copiers and page printers such as laser printers. It also supports a variety of other types of paper that conform to the specifications given in this appendix.

Be careful when choosing paper. Paper unsuitable for the machine may cause jams or may be wrinkled.

Supported Paper

Use standard copy paper for regular copiers or laser printers. The printing quality will be affected by the quality of paper. Poor quality paper may result in unsatisfactory output.

Basic Paper Specifications

The following table lists the specifications of paper that is supported with this machine. Refer to the subsequent sections for further details.

Criteria	Specifications
Weight	Cassettes: 60 to 220 g/m ²
	Multi purpose tray: 60 to 300 g/m ²
Dimensional accuracy	±0.7 mm
Squareness of corners	90° ±0.2°
Moisture content	4 to 6%
Pulp content	80% or more

NOTE

Some recycled paper does not meet requirements for use with this machine as listed in the Basic Paper Specifications shown below, such as moisture or pulp content. For this reason, we recommend purchasing a small amount of recycled paper as a sample for testing prior to use. Choose recycled paper that gives the best printing results and contains low levels of paper dust.

We are not responsible for the problems occurred from the use of paper that does not conform to our specifications.

Choosing the Appropriate Paper

This section describes guidelines for choosing paper.

Condition

Avoid using paper with bent corners or that is curled, dirty, or torn. Do not use paper that has a rough surface or paper fiber lint, or that is especially delicate. Use of paper in any of these conditions will not only deliver poor copies but may also cause jams and shorten the useful life of the machine. Choose paper with a smooth and even surface; however, avoid coated paper or paper with a treated surface as it may damage the drum or fusing unit.

Ingredients

Do not use paper such as paper that has been coated or surface-treated or paper that contains plastic or carbon. Those types of paper may produce harmful fumes from the heat of printing and may damage the drum.

Be sure to use the standard paper that contains at least 80% pulp, i.e., not more than 20% of the total paper content consists of cotton or other fibers.

Supported Paper Sizes

Paper of the following sizes is supported by the machine.

Measurements in the table take into account a ± 0.7 mm dimensional accuracy for length and width. Corner angles must be $90^\circ \pm 0.2^\circ$.

Multi Purpose Tray	Cassette or Multi Purpose Tray
A6-R (105 × 148 mm)	A3 (297 × 420 mm)
B6-R (128 × 182 mm)	B4 (257 × 364 mm)
Hagaki (100×148 mm)	A4 (297 × 210 mm)
Oufuku hagaki (148 × 200 mm)	A4-R (210 × 297 mm)
Executive (7 1/4 × 10 1/2")	B5 (257 × 182 mm)
Envelope DL (110 × 220 mm)	B5-R (182 × 257 mm)
Envelope C5 (162 × 229 mm)	A5-R (148 × 210 mm)
Envelope C4 (229 × 324 mm)	Folio (210 × 330 mm)
ISO B5 (176 × 250 mm)	Ledger
Envelope #10 (Commercial #10) (4 1/8 × 9 1/2")	Legal
Envelope #9 (Commercial #9) (3 7/8 × 8 7/8")	Letter
Envelope #6 (Commercial #6 3/4) (3 5/8 × 6 1/2")	Letter-R
Envelope Monarch (3 7/8 × 7 1/2")	Statement-R
Youkei 2 (114 × 162 mm)	Oficio II
Youkei 4 (105 × 235 mm)	12 × 18"
Size Entry (98 × 148 to 297 × 432 mm)	8K (273 × 394 mm)
	16K (273 × 197 mm)
	16K-R (197 × 273 mm)
	216 × 340 mm
	Size Entry (140 × 182 to 304 × 457 mm)

Smoothness

The paper surface should be smooth, but it must be uncoated. With paper that is too smooth and slippery, several sheets may accidentally be supplied at once, causing jams.

Basis Weight

In countries that use the metric system, basis weight is the weight in grams of one sheet of paper one square meter in area. In the United States, basis weight is the weight in pounds of one ream (500 sheets) of paper cut to the standard size (or trade size) for a specific grade of paper. Paper that is too heavy or too light may be supplied incorrectly or cause paper jams, which may cause excessive wear of the machine. Mixed paper weight (i.e., thickness) may cause several sheets to be supplied at once accidentally and may also cause blurring or other printing problems if the toner fails to adhere correctly.

Moisture Content

Paper moisture content is the ratio of moisture to dryness expressed as a percentage. Moisture affects how the paper is supplied, the electrostatic chargeability of the paper, and how the toner adheres.

Paper moisture content varies depending on the relative humidity in the room. High relative humidity causes paper to become damp, making the edges expand so it appears wavy. Low relative humidity causes paper to lose moisture, making the edges tighten and weakening print contrast.

Wavy or tight edges may cause the paper to slip when it is supplied. Try to keep the moisture content between 4 to 6%.

To maintain the right level of moisture content, bear in mind the following considerations.

- Store paper in a cool, well-ventilated place.
- Store paper flat and unopened in the package. Once the package is opened, reseal it if the paper is not to be used for a while.
- Store paper sealed in the original package and box. Put a pallet under the carton to keep it raised above the floor. Especially during rainy seasons keep the paper a sufficient distance away from wooden or concrete floors.
- Before using paper that has been stored, keep it at the proper moisture level for at least 48 hours.
- Do not store paper where it is exposed to heat, sunlight, or dampness.

Other Paper Specifications

Porosity: The density of the paper fibers

Stiffness: Paper must be stiff enough or it may buckle in the machine, causing jams.

Curl: Most paper naturally tends to curl after the package is opened. When paper passes through the fixing unit, it curls upward slightly. To deliver flat printouts, load the paper so that the curl faces towards the bottom of the paper tray.

Static electricity: During printing, paper is electrostatically charged so that the toner adheres. Choose paper that can be discharged quickly so that copies do not cling together.

Whiteness: Paper whiteness affects print contrast. Use whiter paper for sharper, brighter copies.

Quality: Machine problems may occur if sheet sizes are not uniform or if corners are not square, edges are rough, sheets are uncut, or edges or corners are crushed. In order to prevent these problems, be especially careful when you cut the paper yourself.

Packaging: Choose paper that is properly packaged and stacked in boxes. Ideally, the packaging itself should have been treated with a coating to inhibit moisture.

Specially treated paper: We do not recommend printing onto the following types of paper, even if it conforms to the basic specifications. When you use these kinds of paper, purchase a small amount first as a sample to test.

- Glossy paper
- Watermarked paper
- Paper with an uneven surface
- Perforated paper

Special Paper

This section describes printing onto special paper and print media.

The following paper and media can be used.

- Transparencies
- Preprinted paper
- Bond paper
- Recycled paper
- Thin paper (from 60 g/m² to 64 g/m² or less)
- Letterhead
- Colored paper
- Prepunched paper
- Envelopes
- Cardstocks (Hagaki)
- Thick paper (from 106 g/m² to 300 g/m² or less)
- Labels
- Coated paper
- High-quality paper
- Index Tab Dividers

When using these paper and media, choose those that are designed specifically for copiers or page printers (such as laser printers). Use the multi purpose tray for transparencies, thick paper, envelopes, cardstocks, and label paper.

Choosing Special Paper

Although special paper that meets the following requirements can be used with the machine, print quality will vary considerably due to differences in the construction and quality of special paper. Thus, special paper is more likely than regular paper to cause printing problems. Before purchasing special paper in volume, try testing a sample to ensure the print quality is satisfactory. General precautions when printing onto special paper are given below. Note that we are not responsible for any harm to the user or damage to the machine caused by moisture or specifications of special paper.

Select a cassette or multi purpose tray for special paper.

Transparencies

Transparencies must be able to withstand the heat of printing. Transparencies must meet the following conditions.

Heat resistance	Must withstand at least 190°C
Thickness	0.100 to 0.110 mm
Material	Polyester
Dimensional accuracy	±0.7 mm
Squareness of corners	90° ±0.2°

To avoid problems, use the multi purpose tray for transparencies and load transparencies with the long side facing the machine.

If transparencies jam frequently at output, try pulling the leading edge of sheets gently as they are ejected.

Label

Be sure to feed labels from the multi purpose tray.

For selecting labels, use extreme care so that the adhesive may not come in direct contact with any part of the machine and that the labels are not easily peeled from the carrier sheet. Adhesives that stick to the drum or rollers and peeled labels remaining in the machine may cause a failure.

When printing onto labels, you must be liable for the print quality and possible trouble.

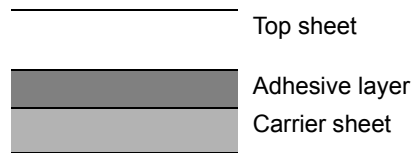

Labels consist of three layers as shown in the illustration. The adhesive layer contains materials that are easily affected by the force applied in the machine. The carrier sheet bears the top sheet until the label is used. This composition of labels may cause more problems.

The label surface must be covered completely with the top sheet. Gaps between labels may cause peeling of labels, resulting in a serious failure.

Some label paper has large margins on the top sheet. When using such paper, do not peel these margins from the carrier sheet before completing output.

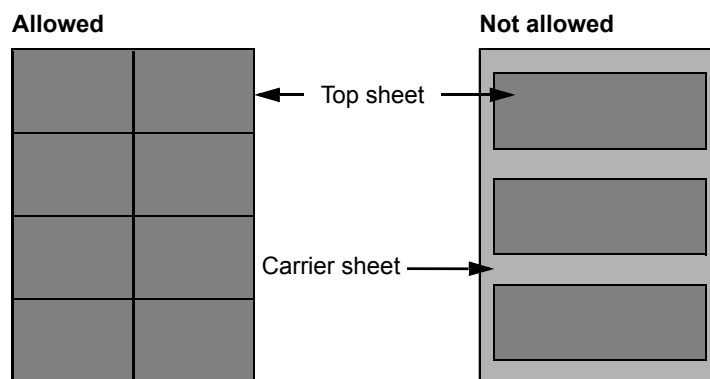

Use label paper that conforms to the following specifications.

Top sheet weight	44 to 74 g/m ²
Basis weight (overall paper weight)	104 to 151 g/m ²
Top sheet thickness	0.086 to 0.107 mm
Overall paper thickness	0.115 to 0.145 mm
Moisture content	4 to 6 % (composite)

Hagaki

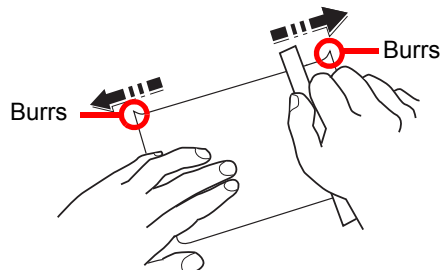

Before loading Hagaki into the multi purpose tray, fan them and align the edges. If the Hagaki paper is curled, straighten it before loading. Printing onto curled Hagaki may cause jams.

Use unfolded Oufuku hagaki (available at post offices). Some Hagaki may still have rough edges developed by a paper cutter on the back side. Remove any such rough edges by placing the Hagaki on a flat surface and rubbing the edges gently a few times with a ruler.

Envelopes

Use the multi purpose tray for envelopes.

Due to the structure of envelopes, printing evenly over the entire surface may not be possible in some cases. Thin envelopes in particular may be wrinkled by the machine in some cases as they pass through. Before purchasing envelopes in volume, try testing a sample to ensure the print quality.

Storing envelopes for a long period may cause them to become wrinkled. Thus, keep the package sealed until you are ready to use them.

Keep the following points in mind.

- Do not use envelopes with exposed adhesive. In addition, do not use the type of envelope in which the adhesive is exposed after the top layer is peeled off. Serious damage may be caused if the paper covering the adhesive comes off in the machine.
- Do not use envelopes with certain special features. For example, do not use envelopes with a grommet for winding a string to close the flap or envelopes with an open or film-covered window.
- If paper jams occur, load fewer envelopes at once.
- To prevent paper jams when printing onto multiple envelopes, do not allow more than ten envelopes to remain in the Inner tray at once.

Thick Paper

Before loading thick paper in the multi purpose tray, fan it and align the edges. Some thick paper may still have rough edges developed by a paper cutter on the back side. Remove any such rough edges just as with Hagaki by placing the paper on a flat surface and rubbing the edges gently a few times with a ruler. Printing onto paper with rough edges may cause jams.



NOTE

If the paper is not supplied correctly even after it is smoothed, load the paper in the multi purpose tray with the leading edge raised a few millimeters.

Colored Paper

Colored paper must conform to the specifications listed on page 11-13. In addition, the pigments in the paper must be able to withstand the heat of printing (up to 200°C or 392°F).

Preprinted Paper

Preprinted paper must conform to the specifications listed on page 11-13. The colored ink must be able to withstand the heat of printing. It must be resistant to silicone oil as well. Do not use paper with a treated surface such as glossy paper used for calendars.

Recycled Paper

Recycled paper must conform to the specifications listed on page 11-13; however, its whiteness may be considered separately.



NOTE

Before purchasing recycled paper in volume, try testing a sample to ensure satisfactory print quality.

Coated Paper

Coated paper is created by treating the surface of the base paper with a coating that provides higher printing quality than plain paper. Coated paper is used for particularly high quality printing.

The surface of high-quality or medium-quality paper is coated with special agents that improve ink adhesion by making the paper surface smoother. These agents are used either to coat both sides of the paper or just one side. The coated side appears slightly glossy.



IMPORTANT

When printing on coated paper in very humid environments, ensure that the paper is kept dry as moisture may cause sheets to stick together when they are fed into the machine. If printing in very humid environments, set coated paper for one sheet each.

Specifications

 **IMPORTANT**

Specifications are subject to change without notice.

 **NOTE**

For more information on using the FAX, refer to the **FAX Operation Guide**.

Common functions

Item		Description
Type		Desktop
Printing Method		Electrophotography by semiconductor laser
Paper Weight	Cassette 1, 2	60 to 220 g/m ²
	Multi Purpose Tray	60 to 300 g/m ²
Paper Type	Cassette 1, 2	Plain, Rough, Vellum, Recycled, Preprinted, Bond, Color (Colour), Prepunched, Letterhead, Thick, High Quality, Custom 1 to 8 (Duplex: Same as Simplex)
	Multi Purpose Tray	Plain, Transparency (OHP film), Rough, Vellum, Labels, Recycled, Preprinted, Bond, Cardstock, Color (Colour), Prepunched, Letterhead, Thick, Coated, Envelope, High Quality, Index Tab Dividers, Custom 1 to 8
Paper Size	Cassette 1, 2	A3, B4, A4, A4-R, B5, B5-R, A5-R, Ledger, Legal, Oficio II, 12 × 18", Letter-R, Letter, Statement-R, Folio, 8K, 16K, 16K-R, 216 × 340 mm, Size Entry (Metric: X; 182 to 457 mm (in 1 mm increments), Y; 140 to 304 mm (in 1 mm increments), Inch: X; 7.17 to 18.00" (in 0.01" increments), Y; 5.51 to 12.00" (in 0.01" increments))
	Multi Purpose Tray	A3, B4, A4, A4-R, B5, B5 (ISO), B5-R, A5-R, B6-R, A6-R, Oufuku hagaki, Hagaki, Envelope DL, Envelope C5, Envelope C4, Envelope #10 (Commercial #10), Envelope #9 (Commercial #9), Envelope #6 (Commercial #6 3/4), Envelope Monarch, Youkei 2, Youkei 4, Ledger, Legal, Oficio II, 12 × 18", Letter, Letter-R, Statement-R, Executive, Folio, 216 × 340 mm, 8K, 16K, 16K-R, Custom (98 × 148 mm to 304.8 × 1,220.0 mm)
Warm-up Time (22°C/71.6°F, 60%)	Power on	3501i: 23 seconds or less 4501i: 23 seconds or less 5501i: 23 seconds or less
	Low Power	3501i: 10 seconds or less 4501i: 10 seconds or less 5501i: 10 seconds or less
	Sleep	3501i: 16 seconds or less 4501i: 16 seconds or less 5501i: 16 seconds or less
Paper Capacity	Cassette 1	500 sheets (80 g/m ²)
	Cassette 2	500 sheets (80 g/m ²)
	Multi Purpose Tray	A4/Letter or less 150 sheets (80 g/m ²) More than A4/Letter 50 sheets (80 g/m ²)

Item		Description
Output Tray Capacity	Inner tray	250 sheets (80 g/m ²) (When the inner job separator (JS-732) is installed, 180 sheets.)
	with optional inner job separator	30 sheets (80 g/m ²)
	with optional inner job separator (JS-732)	100 sheets (80 g/m ²)
	with optional right job separator	70 sheets (80 g/m ²)
Image Write System		Semiconductor laser and electrophotography
Memory		2 GB
Hard Disk		160 GB or more
Interface	Standard	USB Interface Connector: 1 (USB Hi-Speed) Network interface: 1 (10 BASE-T/100 BASE-TX/1000 BASE-T) USBPort: 2 (Hi-Speed USB)
	Option	Fax: 2 Network interface: 1 (10 BASE-T/100 BASE-TX/1000 BASE-T) A maximum of two interface options can be installed. Only one network interface can be installed. When a network interface is installed, only one fax line can be installed.
Operating Environment	Temperature	10 to 32.5°C/50 to 90.5°F
	Humidity	15 to 80 %
	Altitude	2,500 m/8,202 ft maximum
	Brightness	1,500 lux maximum
Dimension (W × D × H) (Main unit only)		25 33/64 × 30 3/16 × 29 13/32" 648 × 767 × 747 mm
Weight		189.6 lb/85.98kg (without toner container)
Space Required (W × D) (Using multi purpose tray)		36 3/8 × 30 3/16" 925 × 767 mm
Power Source		120 V Specification Model: 120 V AC 60 Hz 12.0 A 230 V Specification Model: 220 to 240 V AC 50/60 Hz 7.2 A
Options		Refer to Optional Equipment on page 11-2 .

Copy functions

Item		Description
Copy Speed	3501i	A4/Letter 35 sheets/min
		A4-R/Letter-R 24 sheets/min
		A3/Ledger 17 sheets/min
		B4/Legal 21 sheets/min
		B5 35 sheets/min
		B5-R 24 sheets/min
	4501i	A5-R 17 sheets/min
		A4/Letter 45 sheets/min
		A4-R/Letter-R 31 sheets/min
		A3/Ledger 22 sheets/min
		B4/Legal 27 sheets/min
		B5 45 sheets/min
	5501i	B5-R 31 sheets/min
		A5-R 22 sheets/min
		A4/Letter 55 sheets/min
		A4-R/Letter-R 38 sheets/min
		A3/Ledger 27 sheets/min
		B4/Legal 33 sheets/min
First Copy Time (A4, feed from Cassette)	Black and White	B5 55 sheets/min
		B5-R 38 sheets/min
		A5-R 27 sheets/min
		3501i: 4.7 seconds or less
		4501i: 3.8 seconds or less
		5501i: 3.2 seconds or less
Zoom Level		Manual mode: 25 to 400%, 1% increments Auto mode: Preset Zoom
Continuous Copying		1 to 999 sheets
Resolution		600 × 600 dpi
Supported Original Types		Sheet, Book, 3-dimensional objects (maximum original size: Ledger/A3)
Original Feed System		Fixed

Printer functions

Item		Description
Printing Speed	3501i	A4/Letter 35 sheets/min
		A3/Ledger 17 sheets/min
	4501i	A4/Letter 45 sheets/min
		A3/Ledger 22 sheets/min
	5501i	A4/Letter 55 sheets/min
		A3/Ledger 27 sheets/min
First Print Time (A4, feed from Cassette)	Black and White	3501i: 6.0 seconds or less 4501i: 5.3 seconds or less 5501i: 4.9 seconds or less
Resolution		600 × 600 dpi
Operating System		Windows XP, Windows Server 2003, Windows Vista, Windows 7, Windows 8, Windows Server 2008, Windows Server 2012, Mac OS 10.x
Interface	Standard	USB Interface Connector: 1 (USB Hi-Speed) Network interface: 1 (10 BASE-T/100 BASE-TX/1000 BASE-T) Optional Interface (Option): 1 (For IB-50/IB-51 mounting)
Page Description Language		PRESCRIBE
Emulations		PCL6 (PCL5e, PCL-XL), KPDL3 (PostScript3 compatible)

Scanner functions

Item	Description									
Resolution	600 dpi, 400 dpi, 300 dpi, 200 dpi, 200 × 100 dpi, 200 × 400 dpi (Resolution in FAX mode included)									
File Format	PDF (high compressive, encrypted, PDF/A), JPEG, TIFF, XPS									
Scanning Speed*1	<table border="1"> <tr> <td>3501i</td> <td rowspan="2">1-sided</td> <td>B/W 80 Images/min</td> </tr> <tr> <td>4501i</td> <td>Color 50 Images/min</td> </tr> <tr> <td rowspan="2">5501i</td> <td rowspan="2">2-sided</td> <td>B/W 160 Images/min</td> </tr> <tr> <td>Color 80 Images/min</td> </tr> </table> (A4 landscape, 300 dpi, Image quality: Text/Photo original)	3501i	1-sided	B/W 80 Images/min	4501i	Color 50 Images/min	5501i	2-sided	B/W 160 Images/min	Color 80 Images/min
3501i	1-sided	B/W 80 Images/min								
4501i		Color 50 Images/min								
5501i	2-sided	B/W 160 Images/min								
		Color 80 Images/min								
Interface	Ethernet (10 BASE-T/100 BASE-TX/1000 BASE-T)									
Network Protocol	TCP/IP									
Transmission System	SMB, SMTP, FTP, FTP over SSL, USB, TWAIN*2, WIA*3, WSD									

*1 When using the dual scan document processor (except TWAIN and WIA scanning)

*2 Available Operating System : Windows XP, Windows Server 2003, Windows Vista, Windows Server 2008, Windows Server 2008 R2, Windows 7, Windows Server 2012

*3 Available Operating System : Windows Vista, Windows Server 2003, Windows Server 2008, Windows Server 2008 R2, Windows 7, Windows Server 2012

Document Processor (Option)

Item	Description	
	Document Processor	Document Processor (Dual scan DP)
Original Feed Method	Automatic feed	
Supported Original Types	Sheet originals	
Paper Size	Maximum: Ledger/A3 Minimum: Statement-R/A5-R	Maximum: Ledger/A3 Minimum: Statement-R/A6-R Sizes smaller than B6-R are 50 to 105 g/m ² (one-side/duplex)
Paper Weight	1-sided: 45 to 160 g/m ² 2-sided: 50 to 120 g/m ²	1-sided: 35 to 220 g/m ² 2-sided: 50 to 220 g/m ²
Loading Capacity	100 sheets (50 to 80 g/m ²) maximum When originals have different widths: 30 sheets (50 to 80 g/m ²) maximum	175 sheets (50 to 80 g/m ² A4/Letter or less) maximum When originals have different widths: 30 sheets (50 to 80 g/m ²) maximum
Dimensions (W) × (D) × (H)	22 23/32 × 21 13/64 × 7 5/64" 577 × 534 × 180 mm	23 5/8 × 20 13/64 × 6 45/64" 600 × 513 × 170 mm
Weight	32 lbs. or less /14.5 kg or less	

Paper Feeder (500-sheet x 2) (Option)

Item	Description
Paper Supply Method	Feed & reverse roller method (No. Sheets: 500, 80 g/m ² , 2 cassettes/No. Sheets: 550, 64 g/m ² , 2 cassettes)
Paper Size	A3, B4, A4, A4-R, B5, B5-R, A5-R, Folio, Ledger, Legal, Oficio II, 12 × 18", Letter, Letter-R, Statement-R, 8K, 16K, 16K-R, 216 × 340 mm
Supported Paper	Paper weight: 60 - 256 g/m ² Media types: Plain, Recycled, Thick
Dimensions (W) × (D) × (H)	23 35/64 × 27 35/64 × 12 13/32" 598 × 699.6 × 315 mm
Weight	Approx. 66.1 lbs. / Approx. 30 kg

Large Capacity Feeder (1,500-sheet x 2) (Option)

Item	Description
Paper Supply Method	Feed & reverse roller method (No. Sheets: 3,000 (80 g/m ²)/No. Sheets: 3,500 (64 g/m ²))
Paper Size	A4, B5, Letter
Supported Paper	Paper weight: 60 - 256 g/m ² Media types: Plain, Recycled, Thick
Dimensions (W) × (D) × (H)	23 35/64 × 27 52/64 × 12 26/64" 598 × 706.6 × 315 mm
Weight	Approx. 63.93 lbs / Approx. 29 kg

Side Feeder (3,000-sheet) (Option)

Item	Description
Paper Supply Method	Feed & reverse roller method (No. Sheets: 3,000, 80 g/m ² /No. Sheets: 3,500 64 g/m ²)
Paper Size	A4, B5, Letter
Supported Paper	Paper weight: 60 - 300 g/m ² Media types: Plain, Recycled, Thick
Dimensions (W) × (D) × (H)	12 41/64 × 24 13/32 × 19 27/32" 321 × 620 × 504 mm
Weight	Approx. 55.1 lbs. / Approx. 25 kg

1,000-Sheet Finisher (Option)

Item		Description	
Number of Trays		2 trays	
Paper Size (80 g/m²)	Tray A (Non-stapling)	A3, B4, Ledger, Legal, Oficio II, Folio, 8K, 16K-R, 216 × 340 mm, Statement-R, Executive, Foolscap, A3 Wide(310 × 433 mm), Ledger Wide(310 × 440 mm), 12 × 18": 500 sheets A4, A4-R, B5, A5-R, B6-R, B5-R, Letter, Letter-R, 16K, Custom (98 × 148 mm to 297 × 432 mm): 1,000 sheets	
	Tray B	A3, B4, A4, A4-R, B5, B5 (ISO), B5-R, A5-R, A6-R, B6-R, Letter, Letter-R, Ledger, Legal, Oficio II, 12 × 18", Statement-R, Folio, 8K, 16K, 16K-R, 216 × 340 mm, Oufuku hagaki, Cardstock, Envelope DL, Envelope C5, Envelope C4, Envelope #10 (Commercial #10), Envelope #9 (Commercial #9), Envelope #6 (Commercial #6 3/4), Envelope Monarch, Youkei 2, Youkei 4, Statement-R, Executive, Foolscap, A3 Wide(310 × 433 mm), Ledger Wide(310 × 440 mm), 13 × 19", Custom (98 × 148 mm to 297 × 432 mm) : 100 sheets	
Supported Paper Weight		Stapling: 90 g/m ² or less	
Stapling	Number of Sheets	A3, B4, B5-R, Ledger, Legal, Oficio II, 12 × 18", 216 × 340 mm, Folio, 8K, 16K-R	30 sheets (60 to 90 g/m ²) 20 sheets (91 to 105 g/m ²) 2 cover sheet only (106 g/m ² to 256 g/m ²)
		A4, A4-R, B5, Letter, Letter-R, 16K	50 sheets (60 to 90 g/m ²) 40 sheets (91 to 105 g/m ²) 2 cover sheet only (106 g/m ² to 256 g/m ²)
	Media types	Plain, Recycled, Prepunched, Preprinted, Bond, Letterhead, Color, Coated, Thick, High Quality, Rough, Vellum, Transparency, Labels, Envelope, Cardstock, Custom 1 to 8	
Dimensions (W) × (D) × (H)		26 7/32 × 24 11 × 32 × 42 5/8" 666 × 618.5 × 1,083 mm	
Weight		Approx. 66.1 lbs. or less / Approx. 30 kg or less	

4,000-Sheet Finisher (Option)

Item		Description	
Number of Trays		3 trays	
Paper Size (80 g/m ²)	Tray A (Non-Stapling)	A3, B4, B5-R, Ledger, Legal, 12 × 18", 8K, 13 × 19", A3 Wide (310 × 433 mm), Ledger Wide (310 × 440 mm), Foolscap, Oficio II, 216 × 340 mm, Custom (cassette feeding: 140 × 182 mm to 305 × 458 mm): 1,500 sheets A4, A4-R, B5, Letter, Letter-R, 16K, 16K-R, Folio, Executive, Index Tab Dividers : 4,000 sheets* A5-R, B6, Statement-R: 500 sheets	
	Tray B	A3, B4, A4, A4-R, B5, B5 (ISO), B5-R, A5, A5-R, A6-R, B6-R, Folio, Ledger, Legal, 12 × 18", 8K, Letter, 13 × 19", Letter-R, Statement-R, 16K, 16K-R, Executive, Oficio II, 216 × 340mm, Oufuku hagaki, Cardstock, A3 Wide (310 × 433mm), Ledger Wide (310 × 440mm), Foolscap, Index Tab Dividers, Envelope C4, Custom (cassette feeding: 140 × 182 mm to 305 × 458 mm, multipurpose tray feeding: 98 × 182 mm to 297 × 432 mm) : 200 sheets	
	Tray C	A4, B5, B5 (ISO), B5-R, B6-R, A5-R, A6-R, Letter, Statement-R, 16K: 100 sheets Cardstock, Oufuku hagaki, Envelope DL, Envelope C5, Envelope #10 (Commercial #10), Envelope #9 (Commercial #9), Envelope #6 (Commercial #6 3/4), Envelope Monarch, Youkei 2, Youkei 4, Index Tab Dividers, Banner (98 × 470.1 mm to 297 × 1220 mm), Custom (98 × 148 mm to 304.8 × 1220 mm)	
Stapling	Maximum Number	A3, B4, B5-R, Ledger, Legal, Oficio II, 12 × 18", 216 × 340 mm, Folio, 8K, 16K-R	30 sheets (52 to 90 g/m ²) 30 sheets (91 to 105 g/m ²) 2 cover sheet only (106 g/m ² to 256 g/m ²)
		A4, A4-R, B5, Letter, Letter-R, 16K	65 sheets (52 to 90 g/m ²) 55 sheets (91 to 105 g/m ²) 2 cover sheet only (106 g/m ² to 256 g/m ²)
	Media types	Plain, Recycled, Prepunched, Preprinted, Bond, Letterhead, Color, Coated, Thick, High Quality, Custom 1 to 8	
Dimensions (W) × (D) × (H)		23 29/32 × 26 5/16 × 41 25/32" 607.2 × 668.5 × 1,061.3 mm	
Weight		Approx. 88.2 lbs or less / Approx. 40 kg or less	

* When the Folding Unit is installed, 3000 sheets.

Hole Punch Unit (Option)

Item		Description	
Paper Size	2 Hole	A3, A4, A4-R, A5-R, B4, B5, B5-R, Letter, Letter-R, Ledger, Legal, 12 × 18", Statement, Folio, 8K, 16K, 16K-R	
	3 Hole, 4 Hole	A3, A4, Letter, Ledger, 12 × 18", 8K, 16K	
Paper Weight		45 - 300 g/m ²	
Media types	4,000-Sheet Finisher	Plain, Preprinted, Bond, Recycled, Rough, Letterhead, Color (Colour), Thick, Coated, High Quality, Custom 1 to 8	
	1,000-Sheet Finisher	Plain, Preprinted, Bond, Recycled, Rough, Letterhead, Color (Colour), Thick, Coated, High Quality, Custom 1 to 8	

Mailbox (Option)

Item	Description
Number of Trays	7 trays
Paper Size (80 g/m²)	A3, B4, Ledger, Legal: 50 sheets A4, A4-R, B5, B5-R, A5-R, Foolscap, Letter, Letter-R, 216 × 340 mm, Executive, Executive-R, Folio, 8K, 16K, 16K-R, Statement-R, Oficio II: 100 sheets
Dimensions (W) × (D) × (H)	20 1/16 × 15 3/4 × 18 1/2" 510 mm × 400 mm × 470 mm
Weight	Approx. 22 lbs. / Approx. 10 kg

Center-Folding Unit (Option)

Item	Description	
Sizes	Bi-Fold	A3, B4, A4-R, Ledger, Legal, Letter-R, Oficio II, 8K
	Saddle Stitch	A3, B4, A4-R, Ledger, Legal, Letter-R, Oficio II, 8K
	Tri-Fold	A4-R, Letter-R
Number of Sheets	Bi-Fold	5 sheets (60 to 90 g/m ²) 3 sheets (91 to 120 g/m ²) 1 sheet (121 to 256 g/m ²)
	Saddle Stitch	16 sheets (60 to 90 g/m ²) 13 sheets (91 to 105 g/m ²) 1 cover sheet only (106 g/m ² or heavier)
	Tri-Fold	5 sheets (60 to 90 g/m ²) 3 sheets (91 to 120 g/m ²)
Maximum Number for Storage (80 g/m²)	Bi-Fold	5 sheets or less per set: 30 sets or more 6 to 10 sheets per set: 20 sets or more 11 to 16 sheets per set: 10 sets or more.
	Saddle Stitch	5 sheets or less per set: 30 sets or more 6 to 10 sheets per set: 20 sets or more 11 to 16 sheets per set: 10 sets or more.
	Tri-Fold	1 sheet per set: 30 sets or more 2 to 5 sheets per set: 5 sets or more
Media types	Bi-Fold	Plain, Recycled, Thick, Coated, Bond, Prepunched, Preprinted, Color (Colour), High Quality, Letterhead, Custom 1 to 8
	Saddle Stitch	Plain, Recycled, Thick, Coated, Bond, Prepunched, Preprinted, Color (Colour), High Quality, Letterhead, Custom 1 to 8
	Tri-Fold	Plain, Recycled, Coated, Bond, Prepunched, Preprinted, Color (Colour), High Quality, Letterhead, Custom 1 to 8

Inner Job Separator (Option)

Item	Description
Number of Trays	1 tray
Maximum Sheets	30 sheets (80 g/m ²)
Paper Size	A3, B4, A4, A4-R, B5, B5-R, A5-R, Folio, Ledger, Legal, Letter, Letter-R, Executive, Executive-R, Foolscap, Oficio II, Statement-R, 8K, 16K, 16K-R, 216 × 340 mm
Paper Type	Paper weight: 60 - 256 g/m ² Paper type: Plain, Preprinted, Bond, Rough, Recycled, Letterhead, Color (Colour), Prepunched, Coated, Thick, High Quality, Custom 1 to 8
Dimensions (W) × (D) × (H)	17 7/16 × 15 7/16 × 4 1/64" 443 × 392 × 102 mm
Weight	1.76 lbs. / 0.8 kg

Inner Job Separator (JS-732) (Option)

Item	Description
Number of Trays	1 tray
Maximum Sheets	100 sheets (80 g/m ²)
Paper Size	A3, B4, A4, A4-R, B5, B5-R, A5-R, Folio, Ledger, Foolscap, Legal, Letter, Letter-R, Executive, Executive-R, Oficio II, Statement-R, 8K, 16K, 16K-R, 216 × 340 mm
Paper Type	Paper weight: 60 - 256 g/m ² Paper type: Plain, Preprinted, Bond, Rough, Recycled, Letterhead, Color (Colour), Prepunched, Coated, Thick, High Quality, Custom 1 to 8
Dimensions (W) × (D) × (H)	18 1/2 × 17 43/64 × 4 1/64" 470 × 449 × 102 mm
Weight	Approx. 4.63 lbs. / Approx. 2.1 kg

Right Job Separator (Option)

Item	Description
Number of Trays	1 tray
Maximum Sheets	A4, A4-R, B5, Letter, Letter-R, B5-R, A5-R, Executive, Executive-R, Statement-R, 16K, 16K-R: 70 sheets (80 g/m ²) A3, B4, Folio, Ledger, Legal, Foolscap, Oficio II, 8K, 216 × 340 mm: 30 sheets (80 g/m ²)
Paper Size	A3, B4, A4, A4-R, B5, B5-R, A5-R, Folio, Ledger, Foolscap, Legal, Letter, Letter-R, Executive, Executive-R, Oficio II, Statement-R, 8K, 16K, 16K-R, 216 × 340 mm
Paper Type	Paper weight: 60 - 256 g/m ² Paper type: Plain, Preprinted, Bond, Rough, Recycled, Letterhead, Color (Colour), Prepunched, Coated, Thick, High Quality, Custom 1 to 8
Dimensions (W) × (D) × (H)	14 27/32 × 17 13/32 × 5 29/32" 377 × 442 × 150 mm
Weight	5.1 lbs. / 2.3 kg

Banner Tray (Option)

Item	Description
Max. number of sheets	10 sheets (Multi Purpose tray)
Paper length	210 (8.26") to 304.8 (12") mm
Paper weight	Max. 1220.0 (48 1/64") mm
Paper Type	Paper weight: 136 to 163 g/m ² Paper type: Heavy 2
Dimensions (W) × (D) × (H)	9 27/32 × 14 23/32 × 5 63/64" 250 × 374 × 152 mm
Weight	Approx. 0.78 lbs. / Approx. 0.352 kg



NOTE

Consult your dealer or service representative for recommended paper types.

Glossary

Accessibility

The machine is designed featuring good accessibility even for the elderly and those who are physically challenged or visually impaired. Touch panel characters can be enlarged while the touch panel is adjustable in two angles.

AppleTalk

AppleTalk, which comes with Apple Computer's Mac OS, is a network protocol. AppleTalk enables file/printer sharing and also enables you to utilize application software that is on another computer on the same AppleTalk network.

Auto Form Feed Timeout

During data transmission, the machine may sometimes have to wait until receiving the next data. This is the auto form feed timeout. When the preset timeout passes, the machine automatically prints output. However, no output is performed if the last page has no data to be printed.

Auto-IP

Auto-IP is a module that enables dynamic IPv4 addresses to be assigned to a device on startup. However, DHCP requires a DHCP server. Auto-IP is a server-less method of choosing an IP address. IP addresses between 169.254.0.0 to 169.254.255.255 are reserved for Auto-IP and assigned automatically.

Auto Paper Selection

A function to automatically select paper in the same size as originals when printing

Auto Sleep

A mode designed for electrical power saving, activated when the machine is left unused or there is no data transfer for a specific period. In Sleep mode, power consumption is kept to a minimum.

Bonjour

Bonjour, also known as zero-configuration networking, is a service that automatically detects computers, devices and services on an IP network. Bonjour, because an industry-standard IP protocol is used, allows devices to automatically recognize each other without an IP address being specified or DNS server being set. Bonjour also sends and receives network packets by UDP port 5353. If a firewall is enabled, the user must check that UDP port 5353 is left open so that Bonjour will run correctly. Some firewalls are set up so as to reject only certain Bonjour packets. If Bonjour does not run stably, check the firewall settings and ensure that Bonjour is registered on the exceptions list and that Bonjour packets are accepted. If you install Bonjour on Windows XP Service Pack 2 or later, the Windows firewall will be set up correctly for Bonjour.

Default Gateway

This indicates the device, such as a computer or router, that serves as the entrance/exit (gateway) for accessing computers outside the network that you are on. When no specific gateway is designated for a destination IP address, data is sent to the host designated as the Default Gateway.

DHCP (Dynamic Host Configuration Protocol)

Dynamic Host Configuration Protocol (DHCP) that automatically resolves IP addresses, subnet masks, and gateway addresses on a TCP/IP network. DHCP minimizes the load of network management employing a large number of client computers because it relieves individual clients including printers from the IP address being assigned.

DHCP (IPv6)

DHCP (IPv6) is the next-generation of the Internet's Dynamic Host Configuration Protocol and supports IPv6. It extends the BOOTP startup protocol that defines the protocols used for transferring configuration information to hosts on the network. DHCP (IPv6) permits the DHCP server to use its expanded functionality to send configuration parameters to an IPv6 node. Because the network addresses that can be used are allocated automatically, the IPv6 node management workload is reduced in systems where the administrator has to exercise close control over IP address allocation.

dpi (dots per inch)

A unit for resolution, representing the number of dots printed per inch (25.4 mm).

EcoPrint Mode

A printing mode that helps save toner. Copies made in this mode are thus lighter than normal.

Emulation

The function to interpret and execute other printers' page description languages. The machine emulates operation of PCL6, KPDL3 (PostScript 3 compatible).

FTP (File Transfer Protocol)

A protocol to transfer files on the TCP/IP network, whether the Internet or an intranet. Along with HTTP and SMTP/POP, FTP is now frequently used on the Internet.

Grayscale

A computer color expression. Displayed images of this sort are typically composed of shades of gray, varying from black at the weakest intensity to white at the strongest, without any other colors. Gray levels are displayed in numerical levels: that is, white and black only for 1 bit; 256 gray levels (including white and black) for 8 bits; and 65,536 gray levels for 16 bits.

Help

A [[Help](#)] key is provided on this machine's operation panel. If you are unsure of how to operate the machine, would like more information on its functions or are having problems getting the machine to work properly, press the [[Help](#)] key to view a detailed explanation on the touch panel.

IP Address

An Internet protocol address is a unique number that represents a specific computer or related device on the network. The format of an IP address is four sets of numbers separated by dots, e.g. 192.168.110.171. Each number should be between 0 and 255.

IPP

IPP (Internet Printing Protocol) is a standard that uses TCP/IP networks such as the Internet to enable print jobs to be sent between remote computers and printers. IPP is an extension of the HTTP protocol used to view websites and enables printing to be carried out via routers on printers in remote locations. It also supports the HTTP authentication mechanisms along with SSL server and client authentication as well as encryption.

KPDL (Kyocera Page Description Language)

Kyocera's PostScript page description language compatible with Adobe PostScript Level 3.

Multi Purpose (MP) Tray

The paper supply tray on the right side of the machine. Use this tray instead of the cassettes when printing onto envelopes, Hagaki, transparencies, or labels.

NetBEUI (NetBIOS Extended User Interface)

An interface, developed by IBM in 1985, as an update from NetBIOS. It enables more advanced functions on smaller networks than other protocols such as TCP/IP, etc. It is not suitable for larger networks due to lack of routing capabilities to choose the most appropriate routes. NetBEUI has been adopted by IBM for its OS/2 and Microsoft for its Windows as a standard protocol for file sharing and printing services.

NetWare

Novell's network management software that is able to run on a variety of operating systems.

PDF/A

This is "ISO 19005-1. Document management - Electronic document file format for long-term preservation - Part 1: Use of PDF (PDF/A)", and is a file format based on PDF 1.4. It has been standardized as ISO 19005-1, and is a specialization of PDF, which has been mainly used for printing, for long-term storage. A new part, ISO 19005-2 (PDF/A-2), is currently being prepared.

POP3 (Post Office Protocol 3)

A standard protocol to receive E-mail from the server in which the mail is stored on the Internet or an intranet.

PostScript

A page description language developed by Adobe Systems. It enables flexible font functions and highly-functional graphics, allowing higher quality printing. The first version called Level 1 was launched in 1985, followed by Level 2 that enabled color printing and two-byte languages (e.g. Japanese) in 1990. In 1996, Level 3 was released as an update for the Internet access and PDF format as well as gradual improvements in implementation technologies.

PPM (prints per minute)

This indicates the number of A4 size printouts made in one minute.

Printer Driver

The software to enable you to print data created on any application software. The printer driver for the machine is contained in the DVD enclosed in the package. Install the printer driver on the computer connected to the machine.

RA(Stateless)

The IPv6 router communicates (transmits) information such as the global address prefix using ICMPv6. This information is the Router Advertisement (RA). ICMPv6 stands for Internet Control Message Protocol, and is a IPv6 standard defined in the RFC 2463 "Internet Control Message Protocol (ICMPv6) for the Internet Protocol Version 6 (IPv6) Specification".

Send as E-mail

A function to send the image data stored in the machine as an E-mail attachment. E-mail addresses can be selected from the list or entered at each time.

SMTP (Simple Mail Transfer Protocol)

A protocol for E-mail transmission over the Internet or an intranet. It is used for transferring mail between mail servers as well as for sending mail from clients to their servers.

Status Page

The page lists machine conditions, such as the memory capacity, total number of prints and scans, and paper source settings.

Subnet Mask

The subnet mask is a way of augmenting the network address section of an IP address. A subnet mask represents all network address sections as 1 and all host address sections as 0. The number of bits in the prefix indicates the length of the network address. The term "prefix" refers to something added to the beginning and, in this context, indicates the first section of the IP address. When an IP address is written, the length of the network address is indicated by the prefix length after a forward slash (/). For example, "24" in the address "133.210.2.0/24". In this way, "133.210.2.0/24" denotes the IP address "133.210.2.0" with a 24-bit prefix (network section). This new network address section (originally part of the host address) made possible by the subnet mask is referred to as the subnet address. When you enter the subnet mask, be sure to set the "DHCP" setting to "Off".

TCP/IP (Transmission Control Protocol/Internet Protocol)

TCP/IP is a suite of protocols designed to define the way computers and other devices communicate with each other over a network.

TCP/IP (IPv6)

TCP/IP (IPv6) is based on the current Internet protocol, TCP/IP (IPv4). IPv6 is the next-generation Internet protocol and expands the available address space, which resolves the problem of the lack of addresses under IPv4, while also introducing other improvements such as additional security functionality and the capacity to prioritize data transmission.

TWAIN (Technology Without An Interesting Name)

A technical specification for connecting scanners, digital cameras, and other image equipment to computers. The TWAIN compatible devices enable you to process image data on any relevant application software. TWAIN is adopted on a large amount of graphic software (e.g. Adobe Photoshop) and OCR software.

USB (Universal Serial Bus) 2.0

A USB interface standard for Hi-Speed USB 2.0. The maximum transfer rate is 480 Mbps. This machine is equipped with USB 2.0 for high-speed data transfer.

WIA (Windows Imaging Acquisition)

A function to import images supported after Windows Me/XP from digital cameras and other peripheral devices. This function replaces what TWAIN used to do. The feature is provided as a part of Windows functions and improves ease of operation, so that you import images directly to My Computer without using any application.

Index

(Paper Width Guide) Lock 2-3

Numerics

1,000-Sheet Finisher 11-4
2-sided/Book Original 6-56
4,000-Sheet Finisher 11-4
 Manual Staple 5-73

A

Accessibility 11-33
Accessibility Functions 3-13
Adding a Destination 3-46
Adjusting the Operation Panel Angle 3-3
Adjustment/Maintenance
 Auto Color Correction 8-58
 Background Density Adj. 8-57
 Calibration 8-59, 10-38
 Calibration Cycle 8-58
 Correct Paper Curl 8-59
 Correcting Black Lines 8-57
 Density Adjustment 8-57
 Developer Refresh 8-58, 10-38
 Display Brightness 8-57
 Drum Refresh1 8-58
 Drum Refresh2 8-58
 Memory Diagnostics 8-57
 Silent Mode 8-57
 System Initialization 8-57
 Tone Curve Adjustment 8-58, 10-36
Apache License (Version 2.0) 1-13
AppleTalk 11-33
 Settings 8-47
Application 5-10, 8-60
Auto Form Feed Timeout 11-33
Auto Image Rotation
 Default 8-18
Auto Low Power Mode 3-14
Auto Paper Selection 11-33
Auto Sleep 3-15, 11-33
Auto-IP
 Settings 8-43
Automatic 2-Sided Copy Function 1-16

B

Background Density Adj. 6-24, 8-57
 Default 8-17
Banner printing 4-7
Banner Tray 11-6
Bates Stamp 6-49
Bonjour 11-33
 Settings 2-27, 8-44
Booklet
 Binding Left 6-35
 Binding Right 6-35
 Binding Top 6-35

Border Erase 6-33

C

Calibration 10-38
Canceling Jobs 5-18
Cassette
 Paper Size and Media 8-7
 Loading Paper 3-18
Cassette 1 2-2
Cassette 2 2-2
Cassette 3 to 5 2-5
Cassette 5
 Paper Jams 10-62
Cassette Settings 3-31
Cassette/MP Tray Settings 8-7
Center-Folding Unit
 Paper Jams 10-60
Centering 6-32
Character Entry Method 11-10
Checking the Counter 2-30
Cleaning
 Dual scanning area 10-3
 Machine Interior 10-4
 Platen Cover / Glass Platen 10-2
 Separator 10-5
 Slit Glass 10-3
Cleaning Brush 2-4
Cleaning Cloth Compartment 2-2
Clip Holder 2-3
Coated Paper 11-21
Collate/Offset 6-17
 Default 8-18
Color Selection
 Default 8-17
Combine 6-30
Command Center RX 2-33
Common Settings 8-9
 Customize Status Display 8-26
 Default Screen 8-9
 Display Status/Log 8-25
 Error Handling 8-14
 Function Defaults 8-17
 Function Key Usage 8-26
 Keyboard Layout 8-10
 Language 8-9
 Low Toner Alert Level 8-24
 Manual Staple 8-24
 Measurement 8-14
 Message Banner Print 8-25
 Message Board Settings 8-27
 Offset Documents by Job 8-24
 Offset One Page Documents 8-25
 Orientation Confirmation 8-16
 Original/Paper Settings 8-10
 Paper Output 8-16
 Remote Printing 8-27
 Sound 8-9
 System Stamp 8-20
 USB Keyboard Type 8-20

- Connecting
 - LAN Cable [2-8](#)
 - Power Cable [2-9](#)
 - USB cable [2-9](#)
- Connecting Power Cable [2-9](#)
- Connection Method [2-6](#)
- Continuous Scan
 - Default [8-18](#)
- Conventions Used in This Guide [xi](#)
- Copy [5-20](#), [11-6](#)
- Copy Speed [11-24](#)
- Copying Settings
 - Auto % Priority [8-28](#)
 - Auto Image Rotation Action [8-28](#)
 - Auto Paper Selection [8-28](#)
 - Paper Selection [8-28](#)
 - Preset Limit [8-28](#)
 - Quick Setup Registration [8-29](#)
 - Reserve Next Priority [8-29](#)
- Counting the Number of Pages Printed
 - Count by Paper Size [9-37](#)
 - Counter [2-30](#)
 - Each Job Accounting [9-39](#)
 - Print Accounting Report [9-31](#)
 - Total Job Accounting [9-38](#)
 - Unknown ID Job [9-41](#)
- Cover [6-41](#)
- Custom Box
 - Creating a New Box [5-53](#)
 - Delete [5-64](#)
 - Edit [5-60](#)
 - Printing Documents [5-57](#)
 - Send [5-58](#)
 - Storing Documents [5-56](#)
- D**
- Daily Maintenance
 - Replacing Staples [10-12](#)
 - Toner Container Replacement [10-6](#)
 - Waste Toner Box Replacement [10-9](#)
- Data Sanitization [8-50](#)
- Data Security [8-50](#)
- Data Security Kit [11-7](#)
- Date/Timer/Energy Saver [8-54](#)
 - Auto Error Clear [8-54](#)
 - Auto Panel Reset [8-54](#)
 - Date Format [8-54](#)
 - Date/Time [8-54](#)
 - EnergySaver RecoveryLevel [8-56](#)
 - Error Clear Timer [8-55](#)
 - Error Job Skip [8-55](#)
 - Interrupt Clear Timer [8-55](#)
 - Low Power Timer [8-54](#)
 - Panel Reset Timer [8-55](#)
 - Sleep Level [8-56](#)
 - Sleep Rules [8-55](#)
 - Sleep Timer [8-55](#)
 - Time Zone [8-54](#)
 - Unusable Time [8-55](#)
 - Weekly Timer Settings [8-56](#)
- Default
 - Auto Image Rotation (Copy) [8-18](#)
 - Auto Image Rotation (OCR) [8-19](#)
 - Backgrnd Density (Copy) [8-17](#)
 - BackgrndDens.(Send/Store) [8-17](#)
 - Border Erase Default [8-17](#)
 - Border Erase to Back Page [8-17](#)
 - Collate/Offset [8-18](#)
 - Color Selection [8-17](#)
 - Color TIFF Compression [8-18](#)
 - Cont. Scan (Except FAX) [8-18](#)
 - Continuous Scan [8-18](#)
 - Continuous Scan (FAX) [8-18](#)
 - DP Read Action [8-19](#)
 - EcoPrint [8-18](#)
 - E-mail Subject/Body [8-19](#)
 - FAX TX Resolution [8-17](#)
 - File Format [8-17](#)
 - File Name Entry [8-18](#)
 - File Separation [8-17](#)
 - High Comp. PDF Image [8-18](#)
 - i-FAX Subject/Body [8-19](#)
 - Image Quality (File Format) [8-18](#)
 - JPEG/TIFF Print [8-18](#)
 - Margin [8-18](#)
 - OCR Text Recognition [8-19](#)
 - Org. Image (Send/Store) [8-17](#)
 - Original Image (Copy) [8-17](#)
 - Original Orientation [8-17](#)
 - PDF/A [8-18](#)
 - Prevent Bleed(Send/Store) [8-17](#)
 - Prevent Bleed-thru (Copy) [8-17](#)
 - Primary OCR Language [8-19](#)
 - Repeat Copy [8-20](#)
 - Scan Resolution [8-17](#)
 - Skip Blank Page [8-20](#)
 - Toner Save Level (EcoPrint) [8-18](#)
 - XPS Fit to Page [8-18](#)
 - Zoom [8-17](#)
- Default Gateway [11-33](#)
 - Settings [8-43](#)
- Default Screen [8-9](#)
- Delete after Printed [6-63](#)
- Delete after Transmitted [6-63](#)
- Density [6-21](#)
- Density Adjustment [8-57](#)
- Destination
 - Address Book [5-26](#)
 - Address Book Type [8-53](#)
 - Check before Send [8-29](#)
 - Checking and Editing [5-34](#)
 - Confirmation Screen of Destinations [5-35](#)
 - Entering a New E-mail Address [5-29](#)
 - Entry Check for New Dest. [8-29](#)
 - Multi Sending [5-36](#)
 - Narrow Down [8-53](#)
 - Search [5-27](#)
 - Sort [8-53](#)
 - Specifying a New PC Folder [5-31](#)
 - Speed Dial [5-29](#)

- Device
 - USB Memory 4-2
- DHCP 11-33
 - Settings 8-43
- DHCP (IPv6) 11-34
 - Settings 8-44
- Disposing of the Punch Waste
 - 1,000-Sheet Finisher 10-16
 - 4,000-Sheet Finisher 10-17
- Document Box/Removable Memory
 - Custom Box 8-34
 - Job Box 8-34
 - Quick Setup Registration 8-34
- Document Finisher 2-5
- Document Processor 2-2, 11-4, 11-26
 - How to Load Originals 5-3
 - Loading Originals 5-3
 - Originals Not Supported by the Document Processor 5-3
 - Originals Supported by the Document Processor 5-3
 - Part Names 2-2
- Document Table 11-7
- DP Read Action 6-55
- dpi 11-34
- DSM Scan
 - Protocol Settings 8-45
- Duplex 6-38

E

- EcoPrint
 - Default 8-18
 - Printer 8-35
- EcoPrint Mode 11-34
- Edit Destination
 - Address Book 8-53
 - Address Book Defaults 8-53
 - Contact 3-46
 - Group 3-51
 - One Touch Key 3-54, 8-53
 - Print list 8-53
- E-mail
 - E-mail Subject/Body 6-61
 - Send to Folder (FTP) 5-23
 - Send to Folder (SMB) 5-23
- E-mail Subject/Body
 - Default 8-19
- Emptying the Punch Waste Box (Option)
 - 1,000-Sheet Finisher (Option) 10-16
 - 4,000-Sheet Finisher (Option) 10-17
- Emulation 11-34
 - Selection 8-35
- Emulation Upgrade Kit 11-7
- Encrypted PDF Password 6-64
- Energy Saver Recovery Level 3-14, 3-15, 8-56
- Energy Saving Control Function 1-16
- Energy Star (ENERGY STAR®) Program 1-17
- Enhanced WSD
 - Protocol Settings 8-46

- Enhanced WSD over SSL
 - Protocol Settings 8-46
- Enlarged Display 3-13
- Enter key 3-11
- Entry
 - File Name 6-53
 - Subject 6-61
- Environment 1-3
- Error Handling 8-14

F

- FAX 8-35
- FAX Expansion Memory 11-6
- FAX Kit 11-6
- File
 - Format 6-58
 - PDF 6-60
 - Separation 6-61
- File Format
 - Default 8-17
- File Name Entry 6-53
 - Default 8-18
- File Separation 6-61
 - Default 8-17
- File Size Confirmation 6-63
- First Copy Time 11-24
- First Print Time 11-25
- Fixing unit 10-51
- FMU Connection 5-45
- Fold 6-16
- Folding Unit 2-5, 11-4
- Form Overlay
 - Storing a Form 5-66
- Front Cover 2-2, 2-5
- FTP 11-34

G

- Gigabit Ethernet Board 11-6
- Glossary 11-33
- GPL/LGPL 1-11
- Grayscale 11-34
- Group Authorization Set. 9-15
 - Group Authorization 9-15
 - Group List 9-16
- Guest Authorization Set. 9-18
 - Guest Authorization 9-18
 - Guest Property 9-18
- Guides Provided with the Machine ix

H

- Handle 2-2
- Hard Disk Initialization 8-50
- Help 11-34
- Home 8-28
 - Customize Desktop 3-5
 - Customize Taskbar 3-5
 - Wallpaper 3-5
- Home Screen 3-4
- Host Name 8-43

- HTTP
 - Protocol Settings [8-46](#)
- HTTPS
 - Protocol Settings [8-46](#)
- I**
- Image Repeat [6-46](#)
- Inner Job Separator [11-5](#)
- Inner Job Separator (JS-732) [11-5](#)
- Inner Tray [2-2](#)
- Install
 - Macintosh [2-17](#)
 - Software [2-13](#)
 - Windows [2-14](#)
- Internet
 - Proxy [8-47](#)
- Internet Browser
 - Instructions for use [5-16](#)
- Internet FAX Kit [11-7](#)
- Interrupt Copy [5-22](#)
- IP Address [11-34](#)
 - Settings [8-43](#)
- IPP [11-34](#)
 - Protocol Settings [8-45](#)
- IPP over SSL
 - Protocol Settings [8-45](#)
- IPSec
 - Settings [8-44](#)
- J**
- Job
 - Available Status [7-2](#)
 - Canceling [7-14](#)
 - Checking History [7-11](#)
 - Checking Status [7-2](#)
 - Detailed Information [7-9](#)
 - Detailed Information of Histories [7-13](#)
 - Details of the Status Screens [7-4](#)
 - Displaying History Screen [7-12](#)
 - Displaying Status Screens [7-3](#)
 - Pause and Resumption [7-14](#)
 - Priority Override for Waiting Jobs [7-15](#)
 - Reordering [7-16](#)
 - Sending the Log History [7-13](#)
- Job Account Settings
 - Adding an Account [9-32](#)
 - Counting the Number of Pages Printed [9-38](#)
 - Default Setting [9-36](#)
 - Enabling/Disabling [9-29](#)
 - Login [9-29](#)
 - Logout [9-30](#)
 - Managing Accounts [9-33](#)
 - Print Accounting Report [9-31](#)
 - Restricting the Use of the Machine [9-34](#)
- Job Accounting Settings
 - Counting the Number of Pages Printed [9-27](#)
- Job Box
 - Deletion of Job Retention [8-34](#)
 - Form for Form Overlay [5-66](#)
 - Form Overlay [5-66](#)
 - Private Print/Stored Job [4-14](#)
 - Quick Copy Job Retention [8-34](#)
 - Quick Copy/Proof and Hold [4-16](#)
 - Repeat Copy Job Retention [8-34](#)
- JPEG/TIFF Print
 - Default [8-18](#)
- K**
- Key Counter [11-7](#)
- KIR [8-36](#)
- Knopflerfish License [1-13](#)
- KPDL [11-34](#)
- L**
- Label [11-19](#)
- LAN Cable [2-7](#)
 - Connecting [2-8](#)
- LAN Interface [8-46](#)
- Language [8-9](#)
- Large Capacity Feeder (1,500-sheet x 2) [11-4](#)
- LDAP
 - Protocol Settings [8-46](#)
- Legal Information [1-10](#)
- Legal Restriction on Copying [1-9](#)
- Legal Restriction on Scanning [1-9](#)
- Limitations [8-52](#)
- Loading Originals
 - Loading Originals in the Document Processor [5-3](#)
 - Placing Originals on the Platen [5-2](#)
- Local Authorization [9-15](#)
 - Combine Restriction [9-16](#)
 - Copy Restriction [9-16](#)
 - Duplex Restriction [9-16](#)
 - EcoPrint Restriction [9-16](#)
 - FAX TX Restriction [9-16](#)
 - Print Restriction [9-16](#)
 - Send Restriction [9-16](#)
 - Storing Restr. in Box [9-16](#)
 - Storing Restr. in Memory [9-16](#)
- Login [2-21](#)
- Logout [2-22](#)
- Low Power Mode [3-14](#)
- LPD
 - Protocol Settings [8-45](#)
- M**
- Machine Interior
 - Cleaning [10-4](#)
- Mailbox [2-5](#), [11-4](#)
- Main Power Switch [2-2](#)
- Management [9-1](#)
- Manual Setting (IPv6) [8-44](#)
- Manual Staple [5-73](#)
- Margin [6-32](#)
 - Default [8-18](#)

- Margin/Centering [6-32](#)
- Measurement [8-14](#)
- Media Type Setting [8-10](#)
- Memo Page [6-45](#)
- Memory Diagnostics [8-57](#)
- Mirror Image [6-52](#)
- Mixed Size Originals
 - Combinations [6-13](#)
 - Copy Size [6-14](#)
- Mixed Size Stapling [6-19](#)
- Monotype Imaging License Agreement [1-12](#)
- Multi Purpose Tray [2-3](#)
 - Paper Size and Media Type [3-34](#)
- Multi Sending [5-36](#)

N

- Negative Image [6-52](#)
- NetBEUI [11-35](#)
 - Protocol Settings [8-45](#)
- NetWare [11-35](#)
 - Settings [8-47](#)
- Network
 - Preparation [2-25](#)
 - Settings [8-43](#)
- Network Cable [2-7](#)
- Network Interface [2-7](#)
- Network Interface (Send) [8-49](#)
- Network Interface Connector [2-4](#)
- Network Interface Kit [11-6](#)
- New E-mail Address [5-29](#)
- New PC Folder [5-31](#)

O

- One Touch Key
 - Deleting the Registered Information [3-55](#)
 - Editing [3-55](#)
- One Touch keys
 - Changing the Registered Information [3-55](#)
- OpenSSL License [1-11](#)
- Operation Panel [2-2](#)

Option

- 1,000-Sheet Finisher [11-4](#)
- 4,000-Sheet Finisher [11-4](#)
- Banner Tray [11-6](#)
- Card Authentication Kit [11-6](#)
- Data Security Kit [11-7](#)
- Document Processor [11-4](#)
- Document Table [11-7](#)
- Emulation Upgrade Kit [11-7](#)
- FAX Expansion Memory [11-6](#)
- Folding Unit [11-4](#)
- Hole Punch Unit [11-4](#)
- Inner Job Separator [11-5](#)
- Inner Job Separator (JS-732) [11-5](#)
- Internet FAX Kit [11-7](#)
- Key Counter [11-7](#)
- Large Capacity Feeder (1,500-sheet x 2) [11-4](#)
- Mailbox [11-4](#)
- Network Interface Kit [11-6](#)
- OCR Scan Activation Kit [11-7](#)
- Overview [11-2](#)
- Paper Feeder (500-sheet x2) [11-4](#)
- Printed Document Guard Kit [11-6](#)
- Right Job Separator [11-6](#)
- Side Feeder (3,000-sheet) [11-6](#)
- ThinPrint Option [11-7](#)
- USB Keyboard [11-7](#)
- Wireless Network Interface Kit [11-6](#)
- Option Interface [2-4](#)
- Optional Function [8-52](#)
- Optional Network
 - Basic [8-47](#)
 - Wireless Network [8-48](#)
- Original
 - Automatic Detection [8-11](#)
 - Custom [8-10](#)
 - Settings [8-10](#)
 - Size [1-xiv](#)
- Original eject table [2-2](#)
- Original Image [6-22](#)
 - Default [8-17](#)
- Original Loaded Indicator [2-2](#)
- Original Orientation
 - Default [8-17](#)
 - Orientation Confirmation [8-16](#)
- Original Preview [3-9](#)
- Original Size [6-11](#)
- Original Size Indicator Plates [2-2](#)
- Original SSLeay License [1-11](#)
- Original stopper [2-2](#)
- Original Table [2-2](#)
- Original Width Guides [2-2](#)

P

- Page # [6-43](#)

Paper

- Checking the Remaining Amount of Paper [7-18](#)
- Appropriate Paper [11-14](#)
- Cassette [8-7](#)
- Custom Paper Size [8-10](#)
- Default Paper Source [8-11](#)
- Index Tab Dividers [3-29](#)
- Loading Envelopes [3-28](#)
- Loading Paper [3-16](#)
- Loading Paper in the Cassettes [3-18](#)
- Loading Paper in the Multi Purpose Tray [3-26](#)
- Media Type Setting [8-10](#)
- MP Tray [8-8](#)
- Paper Source for Cover [8-12](#)
- Size and Media [8-7](#), [11-13](#)
- Size and Media Type [3-31](#)
- Special Paper [11-17](#)
- Special Paper Action [8-12](#)
- Specifications [11-13](#)
- Weight [8-13](#)

Paper Before Loading [3-17](#)

Paper Feeder (500-sheet x2) [11-4](#)

Paper Jams [10-39](#)

- 1,000-Sheet Finisher [10-55](#)
- 4,000-Sheet Finisher [10-56](#)
- Bridge Unit [10-54](#)
- Cassette 1 [10-41](#)
- Cassette 2 [10-42](#)
- Cassette 5 [10-62](#)
- Cassettes 3 and 4 [10-43](#)
- Center-Folding Unit [10-60](#)
- Document Processor [10-52](#)
- Duplex unit [10-48](#)
- Fixing unit [10-51](#)
- Inside the Right Covers 1, 3 and 4 [10-47](#)
- Jam Location Indicators [10-39](#)
- Mailbox [10-59](#)
- Multi Purpose Tray [10-46](#)
- Optional Job Separator [10-53](#)

Paper Length Guide [2-3](#)

Paper Output [6-21](#), [8-16](#)

Paper stopper [2-2](#)

Paper Width Adjusting Tab [2-3](#)

Paper Width Guides [2-3](#), [3-19](#)

Part Names [2-1](#)

PDF/A [11-35](#)

Platen [2-2](#)

Platen Cover [2-5](#)

POP3 [11-35](#)

POP3 (E-mail RX)

- Protocol Settings [8-45](#)

PostScript [11-35](#)

Power Cable

- Connecting [2-9](#)

Power Management [1-16](#)

Power Off [2-11](#)

PPM [11-35](#)

Precautions for Use [1-4](#)

Preparing Cables [2-7](#)

Prevent Bleed-thru

- Default [8-17](#)

Print Report

- Font List [8-37](#)
- Network Status [8-37](#)
- Optional Network Status [8-38](#)
- Service Status [8-38](#)
- Status Page [8-37](#)

Print Settings [4-5](#)

Printed Document Guard Kit [11-6](#)

Printer [8-35](#)

- Banner printing [4-7](#)
- Copies [8-35](#)
- CR Action [8-36](#)
- Duplex [8-35](#)
- EcoPrint [8-35](#)
- Emulation [8-35](#)
- Form Feed Timeout [8-36](#)
- Job Name [8-36](#)
- KIR [8-36](#)
- LF Action [8-36](#)
- Orientation [8-36](#)
- Override A4/Letter [8-35](#)
- Paper Feed Mode [8-36](#)
- Toner Save Level (EcoPrint) [8-35](#)
- User Name [8-36](#)

Printer Driver [11-35](#)

- Help [4-6](#)

Printing

- Print setting [4-5](#)
- Printing from PC [4-2](#)

Printing from PC [4-2](#)

Printing Speed [11-25](#)

Priority Override [6-54](#), [7-15](#)

Product Library [ix](#)

Program [5-6](#)

- Editing and Deleting [5-9](#)

- Recalling [5-7](#)

- Registering [5-7](#)

Punch [6-19](#)

Q

Quick No. Search key [3-11](#)

Quick Setup Registration [8-29](#), [8-34](#)

Quick Setup Wizard [2-28](#)

R

RA (Stateless) [11-35](#)

- Settings [8-44](#)

Recycled Paper [11-21](#)

Regarding Trade Names [1-10](#)

Regular Maintenance [10-2](#)

- Disposing of the Punch Waste [10-16](#)

- Replacing Staples [10-12](#)

- Toner Container Replacement [10-6](#)

- Waste Toner Box Replacement [10-9](#)

Release Button [2-4](#)

Remaining amount of toner [7-18](#)

- Repeat Copy
 - Default 8-20
 - Printing 6-54
 - Repeat Copy Job Retention 8-34
 - Replacing Staples
 - 1,000-Sheet Finisher 10-12
 - 4,000-Sheet Finisher 10-13
 - Report
 - Admin Report Settings 8-38
 - Device Log History Settings 8-41
 - Login History Settings 8-40
 - Print Report 8-37
 - Result Report Settings 8-38
 - Secure Comm. Error Log 8-42
 - Sending Log History 8-39
 - Reserve Next 5-21
 - Reserved copy 5-21
 - Resolution 6-61, 11-24, 11-25
 - Responding to Messages 10-23
 - Restart Entire Device 8-52
 - Restart Network 8-46
 - Right Cover 1 Lever 2-3
 - Right Cover 2 2-3
 - Right Cover 2 Lever 2-3
 - Right Cover 3 Lever 2-3
 - Right Job Separator 11-6
- S**
- Safety Conventions 1-2
 - Safety Conventions in This Guide 1-2
 - Scan Resolution
 - Default 8-17
 - Security Level 8-49
 - Send 8-29
 - Send and Forward
 - File format 8-31
 - PDF Encryption Functions 8-32
 - Send and Print 6-62
 - Printing 6-62
 - Storing 6-62
 - Send and Store 6-62
 - Send Result Report 8-38
 - Send Settings
 - Color Type 8-29
 - Default Screen 8-29
 - Dest. Check before Send 8-29
 - Entry Check for New Dest. 8-29
 - HighCompressionPDF Mode 8-30
 - New Destination Entry 8-30
 - OCR Text Recognition Act. 8-30
 - Quick Setup Registration 8-29
 - Recall Destination 8-30
 - Send and Forward 8-30
 - Send to Folder (FTP) 5-23
 - Send to Folder (SMB) 5-23
 - Sending
 - Preparation for Sending a Document to a PC 3-36
 - Separator
 - Cleaning 10-5
 - Serial Number 5-5
 - Setting Date and Time 2-23
 - Setting TWAIN Driver 2-19
 - Sharpness 6-24
 - Shortcuts
 - Adding 5-14
 - Editing and Deleting Shortcuts 5-15
 - Side Feeder (3,000-sheet) 11-6
 - Simple Login 2-22
 - Simple Login Settings
 - Simple Login 9-23
 - Simple Login Key 9-23
 - Skip Blank Page 6-55
 - Sleep 3-15
 - Slit Glass 2-2
 - Slit Glass/Dual scanning area 10-3
 - SMB Client (Transmission)
 - Protocol Settings 8-45
 - SMTP 11-35
 - SMTP (E-mail TX)
 - Protocol Settings 8-45
 - SNMPv1/v2c
 - Protocol Settings 8-46
 - SNMPv3
 - Protocol Settings 8-46
 - Solving Malfunctions 10-18
 - Specifications 11-22
 - 1,000-Sheet Finisher 11-28
 - 4,000-Sheet Finisher 11-29
 - Banner Tray 11-32
 - Center-Folding Unit 11-30
 - Common functions 11-22
 - Document Processor 11-26
 - Hole Punch Unit 11-29
 - Inner Job Separator 11-31
 - Inner Job Separator (JS-732) 11-31
 - Large Capacity Feeder 11-27
 - Mailbox 11-30
 - Paper Feeder (500-sheet x 2) 11-26
 - Printer functions 11-25
 - Right Job Separator 11-32
 - Scanner functions 11-25
 - Specifying Destination 5-26
 - SSL 8-46
 - Staple 6-18
 - Staple Jam 10-63
 - 1,000-Sheet Finisher 10-63
 - 4,000-Sheet Finisher 10-64
 - Staple/Punch 6-18
 - Status Page 11-36
 - Status/Job Cancel 7-1
 - Storing Size 6-64
 - Subnet Mask 11-36
 - Settings 8-43
 - Supplies
 - Checking the Remaining Amount 7-18
 - Support Tray Section of the Multi Purpose Tray 2-3
 - Symbols 1-2
 - System Initialization 8-57

- System Menu 8-2
 - Adjustment/Maintenance 8-57
 - Application 8-60
 - Cassette/MP Tray Settings 8-7
 - Common Settings 8-9
 - Copy 8-28
 - Date/Timer/Energy Saver 8-54
 - Document Box/Removable Memory 8-34
 - Edit Destination 8-53
 - FAX 8-35
 - Home 3-4
 - Internet 8-60
 - Printer 8-35
 - Quick Setup Wizard 2-28
 - Report 8-37
 - Send 8-29
 - System/Network 8-43
 - User Login/Job Accounting 8-53
 - User Property 8-54
- System/Network 8-43
 - Data Security 8-50
 - Document Guard 8-51
 - Interface Block Setting 8-50
 - Network 8-43
 - Network Interface (Send) 8-49
 - Optional Function 8-52
 - Optional Network 8-47
 - Restart Entire Device 8-52
 - Security Level 8-49

T

- TCP/IP 11-36
 - Settings 8-43
- TCP/IP (IPv4)
 - Settings 8-43
 - Setup 2-25
- TCP/IP (IPv6) 11-34
 - Settings 8-44
- Thin Print over SSL
 - Protocol Settings 8-45
- ThinPrint
 - Protocol Settings 8-45
- ThinPrint Option 11-7
- Tone Curve Adjustment 8-58, 10-36
- Toner Container (Black) 2-4
- Toner Container Release Lever 2-4
- Toner Container Replacement 10-6
- Touch Panel 3-4
- TWAIN 11-36
 - Scanning using TWAIN 5-41

U

- USB 11-36
- USB cable
 - Connecting 2-9
- USB Interface 2-7
- USB Interface Connector (B1) 2-4
- USB Keyboard 11-7
- USB Keyboard Type 8-20

- USB Memory
 - Printing 5-68
 - Remove 5-72
 - Save 5-70
- USB Port (A1) 2-2
- USB Port (A2) 2-4
- User Login Setting 9-2
 - Adding a User 9-8
 - Changing User Properties 9-11
 - Group Authorization Set. 9-15
 - Guest Authorization Set. 9-18
 - Local Authentication 9-15
 - Local User List 9-8
 - Obtain NW User Property 9-21
 - Simple Login Settings 9-23
- User Login/Job Accounting
 - Job Accounting Setting 9-27
 - Unknown ID Job 9-41
 - User Login Setting 9-2
- User Property 8-54

W

- Waste Toner Box Status 2-4
- Waste Toner Tray 2-4
- White space 6-45
- WIA 11-36
 - Setting WIA Driver 2-20
- Wireless Network Interface Kit 11-6
- WSD Print
 - Protocol Settings 8-45
- WSD Scan
 - Protocol Settings 8-45

X

- XPS Fit to Page
 - Default 8-18

Z

- Zoom 6-26
 - Default 8-17

**QUALITY
CERTIFICATE**

This machine has passed
all quality controls and
final inspection

KYOCERA Document Solutions America, Inc.**Headquarters**

225 Sand Road,
Fairfield, New Jersey 07004-0008, USA
Phone: +1-973-808-8444
Fax: +1-973-882-6000

Latin America

8240 NW 52nd Terrace Dawson Building, Suite 100
Miami, Florida 33166, USA
Phone: +1-305-421-6640
Fax: +1-305-421-6666

KYOCERA Document Solutions Canada, Ltd.

6120 Kestrel Rd., Mississauga, ON L5T 1S8,
Canada
Phone: +1-905-670-4425
Fax: +1-905-670-8116

**KYOCERA Document Solutions
Mexico, S.A. de C.V.**

Calle Arquimedes No. 130, 4 Piso, Colonia Polanco
Chapultepec, Delegacion Miguel Hidalgo,
Distrito Federal, C.P. 11560, México
Phone: +52-555-383-2741
Fax: +52-555-383-7804

KYOCERA Document Solutions Brazil, Ltda.

Alameda África, 545, Pólo Empresarial Consbrás,
Tamboré, Santana de Parnaíba-SP, CEP 06543-306,
Brazil
Phone: +55-11-4195-8496
Fax: +55-11-4195-6167

**KYOCERA Document Solutions
Australia Pty. Ltd.**

Level 3, 6-10 Talavera Road North Ryde N.S.W, 2113,
Australia
Phone: +61-2-9888-9999
Fax: +61-2-9888-9588

**KYOCERA Document Solutions
New Zealand Ltd.**

Ground Floor, 19 Byron Avenue, Takapuna, Auckland,
New Zealand
Phone: +64-9-415-4517
Fax: +64-9-415-4597

KYOCERA Document Solutions Asia Limited

16/F., Mita Centre, 552-566, Castle Peak Road
Tsuenwan, NT, Hong Kong
Phone: +852-2610-2181
Fax: +852-2610-2063

**KYOCERA Document Solutions
(China) Corporation**

8F, No. 288 Nanjing Road West, Huangpu District,
Shanghai, 200003, China
Phone: +86-21-5301-1777
Fax: +86-21-5302-8300

**KYOCERA Document Solutions
(Thailand) Corp., Ltd.**

335 Ratchadapisek Road, Bangsue, Bangkok 10800,
Thailand
Phone: +66-2-586-0333
Fax: +66-2-586-0278

**KYOCERA Document Solutions
Singapore Pte. Ltd.**

12 Tai Seng Street #04-01A,
Luxasia Building, Singapore 534118
Phone: +65-6741-8733
Fax: +65-6748-3788

**KYOCERA Document Solutions
Hong Kong Limited**

16/F., Mita Centre, 552-566, Castle Peak Road
Tsuenwan, NT, Hong Kong
Phone: +852-3582-4000
Fax: +852-3185-1399

**KYOCERA Document Solutions
Taiwan Corporation**

6F., No.37, Sec. 3, Minquan E. Rd.,
Zhongshan Dist., Taipei 104, Taiwan R.O.C.
Phone: +886-2-2507-6709
Fax: +886-2-2507-8432

KYOCERA Document Solutions Korea Co., Ltd.

18F, Kangnam bldg, 1321-1,
Seocho-Dong, Seocho-Gu, Seoul, Korea
Phone: +822-6933-4050
Fax: +822-747-0084

**KYOCERA Document Solutions
India Private Limited**

First Floor, ORCHID CENTRE
Sector-53, Golf Course Road, Gurgaon 122 002,
India
Phone: +91-0124-4671000
Fax: +91-0124-4671001

KYOCERA Document Solutions Europe B.V.

Bloemlaan 4, 2132 NP Hoofddorp,
The Netherlands
Phone: +31-20-654-0000
Fax: +31-20-653-1256

KYOCERA Document Solutions Nederland B.V.

Beechavenue 25, 1119 RA Schiphol-Rijk,
The Netherlands
Phone: +31-20-5877200
Fax: +31-20-5877260

KYOCERA Document Solutions (U.K.) Limited

Eldon Court, 75-77 London Road,
Reading, Berkshire RG1 5BS,
United Kingdom
Phone: +44-118-931-1500
Fax: +44-118-931-1108

KYOCERA Document Solutions Italia S.p.A.

Via Verdi, 89/91 20063 Cernusco s/N.(MI),
Italy
Phone: +39-02-921791
Fax: +39-02-92179-600

KYOCERA Document Solutions Belgium N.V.

Sint-Martinusweg 199-201 1930 Zaventem,
Belgium
Phone: +32-2-7209270
Fax: +32-2-7208748

KYOCERA Document Solutions France S.A.S.

Espace Technologique de St Aubin
Route de l'Orme 91195 Gif-sur-Yvette CEDEX,
France
Phone: +33-1-69852600
Fax: +33-1-69853409

KYOCERA Document Solutions Espana, S.A.

Edificio Kyocera, Avda. de Manacor No.2,
28290 Las Matas (Madrid), Spain
Phone: +34-91-6318392
Fax: +34-91-6318219

KYOCERA Document Solutions Finland Oy

Atomitie 5C, 00370 Helsinki,
Finland
Phone: +358-9-47805200
Fax: +358-9-47805390

**KYOCERA Document Solutions
Europe B.V., Amsterdam (NL) Zürich Branch**

Hohlstrasse 614, 8048 Zürich,
Switzerland
Phone: +41-44-9084949
Fax: +41-44-9084950

**KYOCERA Document Solutions
Deutschland GmbH**

Otto-Hahn-Strasse 12, 40670 Meerbusch,
Germany
Phone: +49-2159-9180
Fax: +49-2159-918100

KYOCERA Document Solutions Austria GmbH

Eduard-Kittenberger-Gasse 95, 1230 Vienna,
Austria
Phone: +43-1-863380
Fax: +43-1-86338-400

KYOCERA Document Solutions Nordic AB

Esbogatan 16B 164 75 Kista, Sweden
Phone: +46-8-546-550-00
Fax: +46-8-546-550-10

KYOCERA Document Solutions Norge Nuf

Postboks 150 Oppsal, 0619 Oslo,
Norway
Phone: +47-22-62-73-00
Fax: +47-22-62-72-00

KYOCERA Document Solutions Danmark A/S

Ejby Industrivej 60, DK-2600 Glostrup,
Denmark
Phone: +45-70223880
Fax: +45-45765850

KYOCERA Document Solutions Portugal Lda.

Rua do Centro Cultural, 41 (Alvalade) 1700-106 Lisboa,
Portugal
Phone: +351-21-843-6780
Fax: +351-21-849-3312

**KYOCERA Document Solutions
South Africa (Pty) Ltd.**

KYOCERA House, Hertford Office Park,
90 Bekker Road (Cnr. Allandale), Midrand, South Africa.
Phone: +27-11-540-2600
Fax: +27-11-466-3050

KYOCERA Document Solutions Russia LLC

Botanichesky pereulok 5, Moscow, 129090,
Russia
Phone: +7(495)741-0004
Fax: +7(495)741-0018

KYOCERA Document Solutions Middle East

Dubai Internet City, Bldg. 17,
Office 157 P.O. Box 500817, Dubai,
United Arab Emirates
Phone: +971-04-433-0412

KYOCERA Document Solutions Inc.

2-28, 1-chome, Tamatsukuri, Chuo-ku
Osaka 540-8585, Japan
Phone: +81-6-6764-3555
<http://www.kyoceradocumentsolutions.com>

